

Jim Hefferon

<http://joshua.smcvt.edu/linearalgebra>

# Linear Algebra

## Notation

$\mathbb{R}, \mathbb{R}^+, \mathbb{R}^n$	real numbers, reals greater than 0, n-tuples of reals
$\mathbb{N}, \mathbb{C}$	natural numbers: $\{0, 1, 2, \dots\}$ , complex numbers
$(a..b), [a..b]$	interval (open, closed) of reals between a and b
$\langle \dots \rangle$	sequence; like a set but order matters
$V, W, U$	vector spaces
$\vec{v}, \vec{w}, \vec{0}, \vec{0}_V$	vectors, zero vector, zero vector of V
$B, D, \vec{\beta}, \vec{\delta}$	bases, basis vectors
$\mathcal{E}_n = \langle \vec{e}_1, \dots, \vec{e}_n \rangle$	standard basis for $\mathbb{R}^n$
$\text{Rep}_B(\vec{v})$	matrix representing the vector
$\mathcal{P}_n$	set of degree n polynomials
$\mathcal{M}_{n \times m}$	set of $n \times m$ matrices
$[S]$	span of the set S
$M \oplus N$	direct sum of subspaces
$V \cong W$	isomorphic spaces
$h, g$	homomorphisms, linear maps
$H, G$	matrices
$t, s$	transformations; maps from a space to itself
$T, S$	square matrices
$\text{Rep}_{B,D}(h)$	matrix representing the map h
$h_{i,j}$	matrix entry from row i, column j
$Z_{n \times m}, Z, I_{n \times n}, I$	zero matrix, identity matrix
$ T $	determinant of the matrix T
$\mathcal{R}(h), \mathcal{N}(h)$	range space and null space of the map h
$\mathcal{R}_\infty(h), \mathcal{N}_\infty(h)$	generalized range space and null space

### Lower case Greek alphabet, with pronunciation

character	name	character	name
$\alpha$	alpha <i>AL-fuh</i>	$\nu$	nu <i>NEW</i>
$\beta$	beta <i>BAY-tuh</i>	$\xi$	xi <i>KSIGH</i>
$\gamma$	gamma <i>GAM-muh</i>	$\omicron$	omicron <i>OM-uh-CRON</i>
$\delta$	delta <i>DEL-tuh</i>	$\pi$	pi <i>PIE</i>
$\epsilon$	epsilon <i>EP-suh-lon</i>	$\rho$	rho <i>ROW</i>
$\zeta$	zeta <i>ZAY-tuh</i>	$\sigma$	sigma <i>SIG-muh</i>
$\eta$	eta <i>AY-tuh</i>	$\tau$	tau <i>TOW as in cow</i>
$\theta$	theta <i>THAY-tuh</i>	$\upsilon$	upsilon <i>OOP-suh-LON</i>
$\iota$	iota <i>eye-OH-tuh</i>	$\phi$	phi <i>FEE, or FI as in hi</i>
$\kappa$	kappa <i>KAP-uh</i>	$\chi$	chi <i>KI as in hi</i>
$\lambda$	lambda <i>LAM-duh</i>	$\psi$	psi <i>SIGH, or PSIGH</i>
$\mu$	mu <i>MEW</i>	$\omega$	omega <i>oh-MAY-guh</i>

# Preface

---

This book helps students to master the material of a standard US undergraduate first course in Linear Algebra.

The material is standard in that the subjects covered are Gaussian reduction, vector spaces, linear maps, determinants, and eigenvalues and eigenvectors. Another standard is book's audience: sophomores or juniors, usually with a background of at least one semester of calculus. The help that it gives to students comes from taking a developmental approach — this book's presentation emphasizes motivation and naturalness, using many examples as well as extensive and careful exercises.

The developmental approach is what most recommends this book so I will elaborate. Courses at the beginning of a mathematics program focus less on theory and more on calculating. Later courses ask for mathematical maturity: the ability to follow different types of arguments, a familiarity with the themes that underlie many mathematical investigations such as elementary set and function facts, and a capacity for some independent reading and thinking. Some programs have a separate course devoted to developing maturity and some do not. In either case, a Linear Algebra course is an ideal spot to work on this transition. It comes early in a program so that progress made here pays off later but also comes late enough that students are serious about mathematics. The material is accessible, coherent, and elegant. There are a variety of argument styles, including direct proofs, proofs by contradiction, and proofs by induction. And, examples are plentiful.

Helping readers start the transition to being serious students of mathematics requires taking the mathematics seriously so all of the results here are proved. On the other hand, we cannot assume that students have already arrived and so in contrast with more advanced texts this book is filled with examples, often quite detailed.

Some books begin with extensive computations of linear systems, matrix multiplications, and determinants. Then, when vector spaces and linear maps finally appear and definitions and proofs start, the abrupt change can bring students to an abrupt stop. While this book starts with linear reduction, from

the first we do more than compute. The first chapter includes proofs showing that linear reduction gives a correct and complete solution set. Then, with the linear systems work as motivation so that the study of linear combinations is natural, the second chapter starts with the definition of a real vector space. In the schedule below this happens at the start of the third week.

Another example of this book's emphasis on motivation and naturalness is that the third chapter on linear maps does not begin with the definition of homomorphism. Instead we start with the definition of isomorphism, which is natural: students themselves observe that some spaces are "the same" as others. After that, the next section takes the reasonable step of isolating the operation-preservation idea to define homomorphism. This approach loses mathematical slickness but it is a good trade because it gives to students a large gain in sensibility.

A student progresses most in mathematics while doing exercises. In this book problem sets start with simple checks and range up to reasonably involved proofs. Since instructors usually assign about a dozen exercises I have tried to put two dozen in each set, thereby giving a selection. There are even a few that are puzzles taken from various journals, competitions, or problems collections. These are marked with a '?' and as part of the fun I have retained the original wording as much as possible.

That is, as with the rest of the book the exercises are aimed to both build an ability at, and help students experience the pleasure of, *doing* mathematics. Students should see how the ideas arise and should be able to picture themselves doing the same type of work.

**Applications and computers.** The point of view taken here, that students should think of Linear Algebra as about vector spaces and linear maps, is not taken to the complete exclusion of others. Applications and computing are interesting and vital aspects of the subject. Consequently each of this book's chapters closes with a few topics in those areas. They are brief enough that an instructor can do one in a day's class or can assign them as independent or small-group projects. Most simply give a reader a taste of the subject, discuss how Linear Algebra comes in, point to some further reading, and give a few exercises. Whether they figure formally in a course or not these help readers see for themselves that Linear Algebra is a tool that a professional must master.

**Availability.** This book is freely available. In particular, instructors can print copies for students and sell them out of a college bookstore. See <http://joshua.smcvt.edu/linearalgebra> for the license details. That page also contains this book's latest version, answers to the exercises, and the L<sup>A</sup>T<sub>E</sub>X source.

A text is a large and complex project. One of the lessons of software development is that such a project will have errors. I welcome bug reports (contributions are acknowledged in the source). I save them and periodically issue revisions. Please see the contact information on the web page.

If you are reading this on your own. This book's emphasis on motivation and development, and its availability, make it widely used for self-study. If you are an independent student then you may find some advice helpful.

While an experienced instructor knows what subjects and pace suit their class, you may find useful a timetable for a semester. (This is adapted from one contributed by George Ashline.)

<i>week</i>	<i>Monday</i>	<i>Wednesday</i>	<i>Friday</i>
1	One.I.1	One.I.1, 2	One.I.2, 3
2	One.I.3	One.III.1	One.III.2
3	Two.I.1	Two.I.1, 2	Two.I.2
4	Two.II.1	Two.III.1	Two.III.2
5	Two.III.2	Two.III.2, 3	Two.III.3
6	EXAM	Three.I.1	Three.I.1
7	Three.I.2	Three.I.2	Three.II.1
8	Three.II.1	Three.II.2	Three.II.2
9	Three.III.1	Three.III.2	Three.IV.1, 2
10	Three.IV.2, 3	Three.IV.4	Three.V.1
11	Three.V.1	Three.V.2	Four.I.1
12	EXAM	Four.I.2	Four.III.1
13	Five.II.1	-THANKSGIVING BREAK-	
14	Five.II.1, 2	Five.II.2	Five.II.3

This timetable supposes that you already know Section One.II, the elements of vectors. Note that in addition to the exams and the final exam that is not shown, an important part of the above course are the hand-in problem sets that include proofs. The computations are important in this course but so are the proofs.

In the table of contents I have marked subsections as optional if some instructors will pass over them in favor of spending more time elsewhere.

You might pick one or two topics that appeal to you from the end of each chapter. You'll get more from these if you have access to software for calculations. I recommend *Sage*, freely available from <http://sagemath.org>.

My main advice is: do many exercises. I have marked a good sample with ✓'s in the margin. For all of them, you must justify your answer either with a computation or with a proof. Be aware that few inexperienced people can write correct proofs; try to find a knowledgeable person to work with you on these.

Finally, a caution for all students, independent or not: I cannot overemphasize how much the statement, "I understand the material but it's only that I have trouble with the problems" shows a misconception. Being able to do things with the ideas is their entire point. The quotes below express this sentiment admirably. They capture the essence of both the beauty and the power of mathematics and science in general, and of Linear Algebra in particular. (I took

the liberty of formatting them as poetry).

*I know of no better tactic  
than the illustration of exciting principles  
by well-chosen particulars.*

*–Stephen Jay Gould*

*If you really wish to learn  
then you must mount the machine  
and become acquainted with its tricks  
by actual trial.*

*–Wilbur Wright*

Jim Hefferon  
Mathematics, Saint Michael's College  
Colchester, Vermont USA 05439  
<http://joshua.smcvt.edu/linearalgebra>  
2012-Feb-29

*Author's Note.* Inventing a good exercise, one that enlightens as well as tests, is a creative act and hard work. The inventor deserves recognition. But texts have traditionally not given attributions for questions. I have changed that here where I was sure of the source. I would be glad to hear from anyone who can help me to correctly attribute others of the questions.

# Contents

---

## Chapter One: Linear Systems

I Solving Linear Systems . . . . .	1
I.1 Gauss' Method . . . . .	2
I.2 Describing the Solution Set . . . . .	11
I.3 General = Particular + Homogeneous . . . . .	20
II Linear Geometry . . . . .	31
II.1 Vectors in Space* . . . . .	31
II.2 Length and Angle Measures* . . . . .	38
III Reduced Echelon Form . . . . .	45
III.1 Gauss-Jordan Reduction . . . . .	45
III.2 The Linear Combination Lemma . . . . .	50
Topic: Computer Algebra Systems . . . . .	57
Topic: Input-Output Analysis . . . . .	59
Topic: Accuracy of Computations . . . . .	63
Topic: Analyzing Networks . . . . .	67

## Chapter Two: Vector Spaces

I Definition of Vector Space . . . . .	74
I.1 Definition and Examples . . . . .	74
I.2 Subspaces and Spanning Sets . . . . .	85
II Linear Independence . . . . .	95
II.1 Definition and Examples . . . . .	95
III Basis and Dimension . . . . .	106
III.1 Basis . . . . .	106
III.2 Dimension . . . . .	112
III.3 Vector Spaces and Linear Systems . . . . .	118
III.4 Combining Subspaces* . . . . .	125
Topic: Fields . . . . .	134
Topic: Crystals . . . . .	136
Topic: Voting Paradoxes . . . . .	140
Topic: Dimensional Analysis . . . . .	146

### Chapter Three: Maps Between Spaces

I	Isomorphisms . . . . .	153
I.1	Definition and Examples . . . . .	153
I.2	Dimension Characterizes Isomorphism . . . . .	162
II	Homomorphisms . . . . .	169
II.1	Definition . . . . .	169
II.2	Rangespace and Nullspace . . . . .	176
III	Computing Linear Maps . . . . .	187
III.1	Representing Linear Maps with Matrices . . . . .	187
III.2	Any Matrix Represents a Linear Map* . . . . .	197
IV	Matrix Operations . . . . .	204
IV.1	Sums and Scalar Products . . . . .	204
IV.2	Matrix Multiplication . . . . .	207
IV.3	Mechanics of Matrix Multiplication . . . . .	214
IV.4	Inverses . . . . .	223
V	Change of Basis . . . . .	231
V.1	Changing Representations of Vectors . . . . .	231
V.2	Changing Map Representations . . . . .	235
VI	Projection . . . . .	243
VI.1	Orthogonal Projection Into a Line* . . . . .	243
VI.2	Gram-Schmidt Orthogonalization* . . . . .	247
VI.3	Projection Into a Subspace* . . . . .	252
Topic:	Line of Best Fit . . . . .	261
Topic:	Geometry of Linear Maps . . . . .	266
Topic:	Magic Squares . . . . .	272
Topic:	Markov Chains . . . . .	277
Topic:	Orthonormal Matrices . . . . .	283

### Chapter Four: Determinants

I	Definition . . . . .	290
I.1	Exploration* . . . . .	290
I.2	Properties of Determinants . . . . .	295
I.3	The Permutation Expansion . . . . .	299
I.4	Determinants Exist* . . . . .	307
II	Geometry of Determinants . . . . .	314
II.1	Determinants as Size Functions . . . . .	314
III	Laplace's Expansion . . . . .	320
III.1	Laplace's Expansion Formula* . . . . .	320
Topic:	Cramer's Rule . . . . .	325
Topic:	Speed of Calculating Determinants . . . . .	328
Topic:	Projective Geometry . . . . .	331



## Chapter Five: Similarity

I	Complex Vector Spaces . . . . .	343
I.1	Factoring and Complex Numbers; A Review* . . . . .	344
I.2	Complex Representations . . . . .	346
II	Similarity . . . . .	348
II.1	Definition and Examples . . . . .	348
II.2	Diagonalizability . . . . .	350
II.3	Eigenvalues and Eigenvectors . . . . .	354
III	Nilpotence . . . . .	363
III.1	Self-Composition* . . . . .	363
III.2	Strings* . . . . .	367
IV	Jordan Form . . . . .	377
IV.1	Polynomials of Maps and Matrices* . . . . .	377
IV.2	Jordan Canonical Form* . . . . .	385
	Topic: Method of Powers . . . . .	398
	Topic: Stable Populations . . . . .	402
	Topic: Page Ranking . . . . .	404
	Topic: Linear Recurrences . . . . .	408

## Appendix

Propositions . . . . .	A-1
Quantifiers . . . . .	A-3
Techniques of Proof . . . . .	A-4
Sets, Functions, and Relations . . . . .	A-6

\*Starred subsections are optional.



# Linear Systems

## I Solving Linear Systems

Systems of linear equations are common in science and mathematics. These two examples from high school science [Onan] give a sense of how they arise.

The first example is from Physics. Suppose that we have three objects, one with a mass known to be 2 kg and we want to find the unknown masses. Suppose further that experimentation with a meter stick produces these two balances.

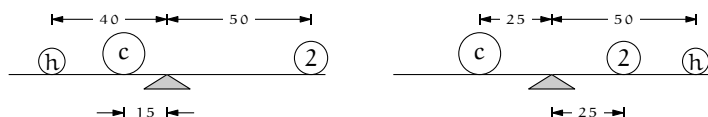

For the masses to balance we must have that the sum of moments on the left equals the sum of moments on the right, where the moment of an object is its mass times its distance from the balance point. That gives a system of two equations.

$$\begin{aligned}40h + 15c &= 100 \\25c &= 50 + 50h\end{aligned}$$

The second example of a linear system is from Chemistry. We can mix, under controlled conditions, toluene  $C_7H_8$  and nitric acid  $HNO_3$  to produce trinitrotoluene  $C_7H_5O_6N_3$  along with the byproduct water (conditions have to be very well controlled — trinitrotoluene is better known as TNT). In what proportion should we mix them? The number of atoms of each element present before the reaction

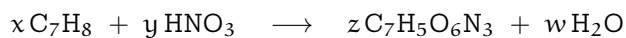

must equal the number present afterward. Applying that in turn to the elements C, H, N, and O gives this system.

$$\begin{aligned}7x &= 7z \\8x + 1y &= 5z + 2w \\1y &= 3z \\3y &= 6z + 1w\end{aligned}$$

Both examples come down to solving a system of equations. In each system, the equations involve only the first power of each variable. This chapter shows how to solve any such system.

## 1.1 Gauss' Method

**1.1 Definition** A *linear combination* of  $x_1, \dots, x_n$  has the form

$$a_1x_1 + a_2x_2 + a_3x_3 + \cdots + a_nx_n$$

where the numbers  $a_1, \dots, a_n \in \mathbb{R}$  are the combination's *coefficients*. A *linear equation* has the form  $a_1x_1 + a_2x_2 + a_3x_3 + \cdots + a_nx_n = d$  where  $d \in \mathbb{R}$  is the *constant*.

An  $n$ -tuple  $(s_1, s_2, \dots, s_n) \in \mathbb{R}^n$  is a *solution* of, or *satisfies*, that equation if substituting the numbers  $s_1, \dots, s_n$  for the variables  $x_1, \dots, x_n$  gives a true statement:  $a_1s_1 + a_2s_2 + \cdots + a_ns_n = d$ .

A *system of linear equations*

$$\begin{aligned}a_{1,1}x_1 + a_{1,2}x_2 + \cdots + a_{1,n}x_n &= d_1 \\a_{2,1}x_1 + a_{2,2}x_2 + \cdots + a_{2,n}x_n &= d_2 \\&\vdots \\a_{m,1}x_1 + a_{m,2}x_2 + \cdots + a_{m,n}x_n &= d_m\end{aligned}$$

has the solution  $(s_1, s_2, \dots, s_n)$  if that  $n$ -tuple is a solution of all of the equations in the system.

**1.2 Example** The combination  $3x_1 + 2x_2$  of  $x_1$  and  $x_2$  is linear. The combination  $3x_1^2 + 2\sin(x_2)$  is not linear, nor is  $3x_1^2 + 2x_2$ .

**1.3 Example** The ordered pair  $(-1, 5)$  is a solution of this system.

$$\begin{aligned}3x_1 + 2x_2 &= 7 \\-x_1 + x_2 &= 6\end{aligned}$$

In contrast,  $(5, -1)$  is not a solution.

Finding the set of all solutions is *solving* the system. We don't need guesswork

or good luck; there is an algorithm that always works. This algorithm is *Gauss' method* (or *Gaussian elimination* or *linear elimination*).

**1.4 Example** To solve this system

$$\begin{array}{rcl} & & 3x_3 = 9 \\ x_1 + 5x_2 - 2x_3 & = & 2 \\ \frac{1}{3}x_1 + 2x_2 & = & 3 \end{array}$$

we transform it, step by step, until it is in a form that we can easily solve.

The first transformation rewrites the system by interchanging the first and third row.

$$\begin{array}{rcl} & & \frac{1}{3}x_1 + 2x_2 = 3 \\ \text{swap row 1 with row 3} \longrightarrow & & x_1 + 5x_2 - 2x_3 = 2 \\ & & 3x_3 = 9 \end{array}$$

The second transformation rescales the first row by multiplying both sides of the equation by 3.

$$\begin{array}{rcl} & & x_1 + 6x_2 = 9 \\ \text{multiply row 1 by 3} \longrightarrow & & x_1 + 5x_2 - 2x_3 = 2 \\ & & 3x_3 = 9 \end{array}$$

The third transformation is the only nontrivial one in this example. We mentally multiply both sides of the first row by  $-1$ , mentally add that to the second row, and write the result in as the new second row.

$$\begin{array}{rcl} & & x_1 + 6x_2 = 9 \\ \text{add } -1 \text{ times row 1 to row 2} \longrightarrow & & -x_2 - 2x_3 = -7 \\ & & 3x_3 = 9 \end{array}$$

The point of these steps is that we've brought the system to a form where we can easily find the value of each variable. The bottom equation shows that  $x_3 = 3$ . Substituting 3 for  $x_3$  in the middle equation shows that  $x_2 = 1$ . Substituting those two into the top equation gives that  $x_1 = 3$ . Thus the system has a unique solution; the solution set is  $\{(3, 1, 3)\}$ .

Most of this subsection and the next one consists of examples of solving linear systems by Gauss' method. We will use it throughout the book. It is fast and easy. But before we do those examples we will first show that this method is also safe in that it never loses solutions or picks up extraneous solutions.

**1.5 Theorem (Gauss' method)** If a linear system is changed to another by one of these operations

- (1) an equation is swapped with another
- (2) an equation has both sides multiplied by a nonzero constant
- (3) an equation is replaced by the sum of itself and a multiple of another

then the two systems have the same set of solutions.

Each of the three Gauss' method operations has a restriction. Multiplying a row by 0 is not allowed because obviously that can change the solution set of the system. Similarly, adding a multiple of a row to itself is not allowed because adding  $-1$  times the row to itself has the effect of multiplying the row by 0. Finally, we disallow swapping a row with itself to make some results in the fourth chapter easier to state and remember, and also because it's pointless.

**PROOF** We will cover the equation swap operation here. The other two cases are Exercise 31.

Consider the swap of row  $i$  with row  $j$ . The tuple  $(s_1, \dots, s_n)$  satisfies the system before the swap if and only if substituting the values for the variables, the  $s$ 's for the  $x$ 's, gives a conjunction of true statements:  $a_{1,1}s_1 + a_{1,2}s_2 + \dots + a_{1,n}s_n = d_1$  and  $\dots$   $a_{i,1}s_1 + a_{i,2}s_2 + \dots + a_{i,n}s_n = d_i$  and  $\dots$   $a_{j,1}s_1 + a_{j,2}s_2 + \dots + a_{j,n}s_n = d_j$  and  $\dots$   $a_{m,1}s_1 + a_{m,2}s_2 + \dots + a_{m,n}s_n = d_m$ .

In a list of statements joined with 'and' we can rearrange the order of the statements. Thus this requirement is met if and only if  $a_{1,1}s_1 + a_{1,2}s_2 + \dots + a_{1,n}s_n = d_1$  and  $\dots$   $a_{j,1}s_1 + a_{j,2}s_2 + \dots + a_{j,n}s_n = d_j$  and  $\dots$   $a_{i,1}s_1 + a_{i,2}s_2 + \dots + a_{i,n}s_n = d_i$  and  $\dots$   $a_{m,1}s_1 + a_{m,2}s_2 + \dots + a_{m,n}s_n = d_m$ . This is exactly the requirement that  $(s_1, \dots, s_n)$  solves the system after the row swap. QED

**1.6 Definition** The three operations from Theorem 1.5 are the *elementary reduction operations*, or *row operations*, or *Gaussian operations*. They are *swapping*, *multiplying by a scalar* (or *rescaling*), and *row combination*.

When writing out the calculations, we will abbreviate 'row  $i$ ' by ' $\rho_i$ '. For instance, we will denote a row combination operation by  $k\rho_i + \rho_j$ , with the row that changes written second. To save writing we will often combine addition steps when they use the same  $\rho_i$ ; see the next example.

**1.7 Example** Gauss' method systematically applies the row operations to solve a system. Here is a typical case.

$$\begin{array}{rcl} x + y & = & 0 \\ 2x - y + 3z & = & 3 \\ x - 2y - z & = & 3 \end{array}$$

We begin by using the first row to eliminate the  $2x$  in the second row and the  $x$  in the third. To get rid of the  $2x$ , we mentally multiply the entire first row by  $-2$ , add that to the second row, and write the result in as the new second row. To eliminate the  $x$  leading the third row, we multiply the first row by  $-1$ , add that to the third row, and write the result in as the new third row.

$$\begin{array}{rcl} & x + y & = 0 \\ \xrightarrow{-2\rho_1 + \rho_2} & -3y + 3z & = 3 \\ \xrightarrow{-\rho_1 + \rho_3} & -3y - z & = 3 \end{array}$$

To finish we transform the second system into a third system, where the last equation involves only one unknown. We use the second row to eliminate  $y$  from

the third row.

$$\begin{array}{rcl} x + y & = & 0 \\ \xrightarrow{-\rho_2 + \rho_3} & & -3y + 3z = 3 \\ & & -4z = 0 \end{array}$$

Now the system's solution is easy to find. The third row shows that  $z = 0$ . Substitute that back into the second row to get  $y = -1$  and then substitute back into the first row to get  $x = 1$ .

**1.8 Example** For the Physics problem from the start of this chapter, Gauss' method gives this.

$$\begin{array}{rcl} 40h + 15c = 100 & & 40h + 15c = 100 \\ \xrightarrow{5/4\rho_1 + \rho_2} & & (175/4)c = 175 \\ -50h + 25c = 50 & & \end{array}$$

So  $c = 4$ , and back-substitution gives that  $h = 1$ . (We will solve the Chemistry problem later.)

**1.9 Example** The reduction

$$\begin{array}{rcl} x + y + z = 9 & & x + y + z = 9 \\ 2x + 4y - 3z = 1 & \xrightarrow{-2\rho_1 + \rho_2} & 2y - 5z = -17 \\ 3x + 6y - 5z = 0 & \xrightarrow{-3\rho_1 + \rho_3} & 3y - 8z = -27 \\ & & \\ & \xrightarrow{-(3/2)\rho_2 + \rho_3} & \\ & & x + y + z = 9 \\ & & 2y - 5z = -17 \\ & & -(1/2)z = -(3/2) \end{array}$$

shows that  $z = 3$ ,  $y = -1$ , and  $x = 7$ .

As illustrated above, the point of Gauss' method is to use the elementary reduction operations to set up back-substitution.

**1.10 Definition** In each row of a system, the first variable with a nonzero coefficient is the row's *leading variable*. A system is in *echelon form* if each leading variable is to the right of the leading variable in the row above it (except for the leading variable in the first row).

**1.11 Example** The prior three examples only used the operation of row combination. This linear system requires the swap operation to get it into echelon form because after the first combination

$$\begin{array}{rcl} x - y & = & 0 \\ 2x - 2y + z + 2w = 4 & \xrightarrow{-2\rho_1 + \rho_2} & z + 2w = 4 \\ y + w = 0 & & y + w = 0 \\ 2z + w = 5 & & 2z + w = 5 \end{array}$$

the second equation has no leading  $y$ . To get one, we put in place a lower-down row that has a leading  $y$ .

$$\begin{array}{rcl} x - y & = & 0 \\ \xrightarrow{\rho_2 \leftrightarrow \rho_3} & & y + w = 0 \\ & & z + 2w = 4 \\ & & 2z + w = 5 \end{array}$$

(Had there been more than one suitable row below the second then we could have swapped in any one.) With that, Gauss' method proceeds as before.

$$\begin{array}{rcl} x - y & = & 0 \\ -2\rho_3 + \rho_4 & y + w & = 0 \\ & z + 2w & = 4 \\ & -3w & = -3 \end{array}$$

Back-substitution gives  $w = 1$ ,  $z = 2$ ,  $y = -1$ , and  $x = -1$ .

The row rescaling operation is not needed, strictly speaking, to solve linear systems. But we will use it later in this chapter as part of a variation on Gauss' method, the Gauss-Jordan method.

All of the systems seen so far have the same number of equations as unknowns. All of them have a solution, and for all of them there is only one solution. We finish this subsection by seeing some other things that can happen.

**1.12 Example** This system has more equations than variables.

$$\begin{array}{rcl} x + 3y & = & 1 \\ 2x + y & = & -3 \\ 2x + 2y & = & -2 \end{array}$$

Gauss' method helps us understand this system also, since this

$$\begin{array}{rcl} x + 3y & = & 1 \\ -2\rho_1 + \rho_2 & -5y & = -5 \\ -2\rho_1 + \rho_3 & -4y & = -4 \end{array}$$

shows that one of the equations is redundant. Echelon form

$$\begin{array}{rcl} x + 3y & = & 1 \\ -(4/5)\rho_2 + \rho_3 & -5y & = -5 \\ & 0 & = 0 \end{array}$$

gives that  $y = 1$  and  $x = -2$ . The ' $0 = 0$ ' reflects the redundancy.

Gauss' method is also useful on systems with more variables than equations. Many examples are in the next subsection.

Another way that linear systems can differ from the examples shown earlier is that some linear systems do not have a unique solution. This can happen in two ways.

The first is that a system can fail to have any solution at all.

**1.13 Example** Contrast the system in the last example with this one.

$$\begin{array}{rcl} x + 3y & = & 1 \\ 2x + y & = & -3 \\ 2x + 2y & = & 0 \end{array} \quad \begin{array}{rcl} x + 3y & = & 1 \\ -2\rho_1 + \rho_2 & -5y & = -5 \\ -2\rho_1 + \rho_3 & -4y & = -2 \end{array}$$



Here the system is inconsistent: no pair of numbers satisfies all of the equations simultaneously. Echelon form makes this inconsistency obvious.

$$\begin{array}{r} x + 3y = 1 \\ \xrightarrow{-(4/5)\rho_2 + \rho_3} -5y = -5 \\ 0 = 2 \end{array}$$

The solution set is empty.

**1.14 Example** The prior system has more equations than unknowns, but that is not what causes the inconsistency—Example 1.12 has more equations than unknowns and yet is consistent. Nor is having more equations than unknowns necessary for inconsistency, as we see with this inconsistent system that has the same number of equations as unknowns.

$$\begin{array}{r} x + 2y = 8 \\ 2x + 4y = 8 \end{array} \quad \xrightarrow{-2\rho_1 + \rho_2} \quad \begin{array}{r} x + 2y = 8 \\ 0 = -8 \end{array}$$

The other way that a linear system can fail to have a unique solution, besides having no solutions, is to have many solutions.

**1.15 Example** In this system

$$\begin{array}{r} x + y = 4 \\ 2x + 2y = 8 \end{array}$$

any pair of real numbers  $(s_1, s_2)$  satisfying the first equation also satisfies the second. The solution set  $\{(x, y) \mid x + y = 4\}$  is infinite; some of its members are  $(0, 4)$ ,  $(-1, 5)$ , and  $(2.5, 1.5)$ .

The result of applying Gauss' method here contrasts with the prior example because we do not get a contradictory equation.

$$\xrightarrow{-2\rho_1 + \rho_2} \quad \begin{array}{r} x + y = 4 \\ 0 = 0 \end{array}$$

Don't be fooled by the final system in that example. A ' $0 = 0$ ' equation is not the signal that a system has many solutions.

**1.16 Example** The absence of a ' $0 = 0$ ' does not keep a system from having many different solutions. This system is in echelon form has no ' $0 = 0$ ', but has infinitely many solutions.

$$\begin{array}{r} x + y + z = 0 \\ y + z = 0 \end{array}$$

Some solutions are:  $(0, 1, -1)$ ,  $(0, 1/2, -1/2)$ ,  $(0, 0, 0)$ , and  $(0, -\pi, \pi)$ . There are infinitely many solutions because any triple whose first component is 0 and whose second component is the negative of the third is a solution.

Nor does the presence of a ' $0 = 0$ ' mean that the system must have many solutions. Example 1.12 shows that. So does this system, which does not have

any solutions at all despite that in echelon form it has a '0 = 0' row.

$$\begin{array}{rcl}
 2x & -2z = 6 & 2x & -2z = 6 \\
 & y + z = 1 & \xrightarrow{-\rho_1 + \rho_3} & y + z = 1 \\
 2x + y - z = 7 & & & y + z = 1 \\
 & 3y + 3z = 0 & & 3y + 3z = 0 \\
 & & & 2x - 2z = 6 \\
 & & \xrightarrow{-\rho_2 + \rho_3} & y + z = 1 \\
 & & \xrightarrow{-3\rho_2 + \rho_4} & 0 = 0 \\
 & & & 0 = -3
 \end{array}$$

We will finish this subsection with a summary of what we've seen so far about Gauss' method.

Gauss' method uses the three row operations to set a system up for back substitution. If any step shows a contradictory equation then we can stop with the conclusion that the system has no solutions. If we reach echelon form without a contradictory equation, and each variable is a leading variable in its row, then the system has a unique solution and we find it by back substitution. Finally, if we reach echelon form without a contradictory equation, and there is not a unique solution—that is, at least one variable is not a leading variable—then the system has many solutions.

The next subsection deals with the third case. We will see that such a system must have infinitely many solutions and we will describe the solution set.

**Note** For all exercises, you must justify your answer. For instance, if a question asks whether a system has a solution then you must justify a yes response by producing the solution and must justify a no response by showing that no solution exists.

### Exercises

- ✓ 1.17 Use Gauss' method to find the unique solution for each system.

$$\begin{array}{ll}
 \text{(a)} & \begin{array}{l} 2x + 3y = 13 \\ x - y = -1 \end{array} \\
 \text{(b)} & \begin{array}{l} x - z = 0 \\ 3x + y = 1 \\ -x + y + z = 4 \end{array}
 \end{array}$$

- ✓ 1.18 Use Gauss' method to solve each system or conclude 'many solutions' or 'no solutions'.

$$\begin{array}{llll}
 \text{(a)} & 2x + 2y = 5 & \text{(b)} & -x + y = 1 \\
 & x - 4y = 0 & & x + y = 2 \\
 \text{(c)} & x - 3y + z = 1 & \text{(d)} & -x - y = 1 \\
 & x + y + 2z = 14 & & -3x - 3y = 2 \\
 \text{(e)} & 4y + z = 20 & \text{(f)} & 2x + z + w = 5 \\
 & 2x - 2y + z = 0 & & y - w = -1 \\
 & x + z = 5 & & 3x - z - w = 0 \\
 & x + y - z = 10 & & 4x + y + 2z + w = 9
 \end{array}$$

- ✓ 1.19 We can solve linear systems by methods other than Gauss' method. One often taught in high school is to solve one of the equations for a variable, then substitute the resulting expression into other equations. Then we repeat that step until there is an equation with only one variable. From that we get the first number in the solution and then we get the rest with back-substitution. This method takes longer

than Gauss' method, since it involves more arithmetic operations, and is also more likely to lead to errors. To illustrate how it can lead to wrong conclusions, we will use the system

$$\begin{aligned}x + 3y &= 1 \\2x + y &= -3 \\2x + 2y &= 0\end{aligned}$$

from Example 1.13.

(a) Solve the first equation for  $x$  and substitute that expression into the second equation. Find the resulting  $y$ .

(b) Again solve the first equation for  $x$ , but this time substitute that expression into the third equation. Find this  $y$ .

What extra step must a user of this method take to avoid erroneously concluding a system has a solution?

- ✓ 1.20 For which values of  $k$  are there no solutions, many solutions, or a unique solution to this system?

$$\begin{aligned}x - y &= 1 \\3x - 3y &= k\end{aligned}$$

- ✓ 1.21 This system is not linear, in some sense,

$$\begin{aligned}2 \sin \alpha - \cos \beta + 3 \tan \gamma &= 3 \\4 \sin \alpha + 2 \cos \beta - 2 \tan \gamma &= 10 \\6 \sin \alpha - 3 \cos \beta + \tan \gamma &= 9\end{aligned}$$

and yet we can nonetheless apply Gauss' method. Do so. Does the system have a solution?

- ✓ 1.22 [Anton] What conditions must the constants, the  $b$ 's, satisfy so that each of these systems has a solution? *Hint.* Apply Gauss' method and see what happens to the right side.

$$\begin{array}{ll} \text{(a)} & x - 3y = b_1 \\ & 3x + y = b_2 \\ & x + 7y = b_3 \\ & 2x + 4y = b_4 \end{array} \quad \begin{array}{l} \text{(b)} \\ \\ \\ \\ \end{array} \begin{array}{l} x_1 + 2x_2 + 3x_3 = b_1 \\ 2x_1 + 5x_2 + 3x_3 = b_2 \\ x_1 + 8x_3 = b_3 \\ \end{array}$$

1.23 True or false: a system with more unknowns than equations has at least one solution. (As always, to say 'true' you must prove it, while to say 'false' you must produce a counterexample.)

1.24 Must any Chemistry problem like the one that starts this subsection — a balance the reaction problem — have infinitely many solutions?

- ✓ 1.25 Find the coefficients  $a$ ,  $b$ , and  $c$  so that the graph of  $f(x) = ax^2 + bx + c$  passes through the points  $(1, 2)$ ,  $(-1, 6)$ , and  $(2, 3)$ .

1.26 After Theorem 1.5 we note that multiplying a row by 0 is not allowed because that could change a solution set. Give an example of a system with solution set  $S_0$  where after multiplying a row by 0 the new system has a solution set  $S_1$  and  $S_0$  is a proper subset of  $S_1$ . Give an example where  $S_0 = S_1$ .

1.27 Gauss' method works by combining the equations in a system to make new equations.

(a) Can we derive the equation  $3x - 2y = 5$  by a sequence of Gaussian reduction steps from the equations in this system?

$$\begin{aligned}x + y &= 1 \\4x - y &= 6\end{aligned}$$

- (b) Can we derive the equation  $5x - 3y = 2$  with a sequence of Gaussian reduction steps from the equations in this system?

$$\begin{aligned} 2x + 2y &= 5 \\ 3x + y &= 4 \end{aligned}$$

- (c) Can we derive  $6x - 9y + 5z = -2$  by a sequence of Gaussian reduction steps from the equations in the system?

$$\begin{aligned} 2x + y - z &= 4 \\ 6x - 3y + z &= 5 \end{aligned}$$

- 1.28 Prove that, where  $a, b, \dots, e$  are real numbers and  $a \neq 0$ , if

$$ax + by = c$$

has the same solution set as

$$ax + dy = e$$

then they are the same equation. What if  $a = 0$ ?

- ✓ 1.29 Show that if  $ad - bc \neq 0$  then

$$\begin{aligned} ax + by &= j \\ cx + dy &= k \end{aligned}$$

has a unique solution.

- ✓ 1.30 In the system

$$\begin{aligned} ax + by &= c \\ dx + ey &= f \end{aligned}$$

each of the equations describes a line in the  $xy$ -plane. By geometrical reasoning, show that there are three possibilities: there is a unique solution, there is no solution, and there are infinitely many solutions.

- 1.31 Finish the proof of Theorem 1.5.

- 1.32 Is there a two-unknowns linear system whose solution set is all of  $\mathbb{R}^2$ ?

- ✓ 1.33 Are any of the operations used in Gauss' method redundant? That is, can we make any of the operations from a combination of the others?

- 1.34 Prove that each operation of Gauss' method is reversible. That is, show that if two systems are related by a row operation  $S_1 \rightarrow S_2$  then there is a row operation to go back  $S_2 \rightarrow S_1$ .

- ? 1.35 [Anton] A box holding pennies, nickels and dimes contains thirteen coins with a total value of 83 cents. How many coins of each type are in the box?

- ? 1.36 [Con. Prob. 1955] Four positive integers are given. Select any three of the integers, find their arithmetic average, and add this result to the fourth integer. Thus the numbers 29, 23, 21, and 17 are obtained. One of the original integers is:

- (a) 19    (b) 21    (c) 23    (d) 29    (e) 17

- ? ✓ 1.37 [Am. Math. Mon., Jan. 1935] Laugh at this: AHAHA + TEHE = TEHAW. It resulted from substituting a code letter for each digit of a simple example in addition, and it is required to identify the letters and prove the solution unique.

- ? 1.38 [Wohascum no. 2] The Wohascum County Board of Commissioners, which has 20 members, recently had to elect a President. There were three candidates (A, B, and C); on each ballot the three candidates were to be listed in order of preference, with no abstentions. It was found that 11 members, a majority, preferred A over B (thus the other 9 preferred B over A). Similarly, it was found that 12 members preferred C over A. Given these results, it was suggested that B should withdraw, to enable a runoff election between A and C. However, B protested, and it was

then found that 14 members preferred B over C! The Board has not yet recovered from the resulting confusion. Given that every possible order of A, B, C appeared on at least one ballot, how many members voted for B as their first choice?

? 1.39 [Am. Math. Mon., Jan. 1963] “This system of  $n$  linear equations with  $n$  unknowns,” said the Great Mathematician, “has a curious property.”

“Good heavens!” said the Poor Nut, “What is it?”

“Note,” said the Great Mathematician, “that the constants are in arithmetic progression.”

“It’s all so clear when you explain it!” said the Poor Nut. “Do you mean like  $6x + 9y = 12$  and  $15x + 18y = 21$ ?”

“Quite so,” said the Great Mathematician, pulling out his bassoon. “Indeed, the system has a unique solution. Can you find it?”

“Good heavens!” cried the Poor Nut, “I am baffled.”

Are you?

## I.2 Describing the Solution Set

A linear system with a unique solution has a solution set with one element. A linear system with no solution has a solution set that is empty. In these cases the solution set is easy to describe. Solution sets are a challenge to describe only when they contain many elements.

2.1 Example This system has many solutions because in echelon form

$$\begin{array}{rcl}
 2x & + & z = 3 \\
 x - y - z = 1 & \xrightarrow{-(1/2)\rho_1 + \rho_2} & -y - (3/2)z = -1/2 \\
 3x - y = 4 & \xrightarrow{-(3/2)\rho_1 + \rho_3} & -y - (3/2)z = -1/2 \\
 & & \\
 & & 2x + z = 3 \\
 & \xrightarrow{-\rho_2 + \rho_3} & -y - (3/2)z = -1/2 \\
 & & 0 = 0
 \end{array}$$

not all of the variables are leading variables. Theorem 1.5 shows that an  $(x, y, z)$  satisfies the first system if and only if it satisfies the third. So we can describe the solution set  $\{(x, y, z) \mid 2x + z = 3 \text{ and } x - y - z = 1 \text{ and } 3x - y = 4\}$  as  $\{(x, y, z) \mid 2x + z = 3 \text{ and } -y - 3z/2 = -1/2\}$ . However, this second description is not optimal. It has two equations instead of three but it still has some hard to understand interaction among the variables.

To improve the description, use the variable that does not lead any equation,  $z$ , to describe the variables that do lead,  $x$  and  $y$ . The second equation gives  $y = (1/2) - (3/2)z$  and the first equation gives  $x = (3/2) - (1/2)z$ . Thus the solution set is this.

$$\{(x, y, z) = ((3/2) - (1/2)z, (1/2) - (3/2)z, z) \mid z \in \mathbb{R}\} \quad (*)$$

For instance,  $(1/2, -5/2, 2)$  is a solution because taking  $z = 2$  gives a first component of  $1/2$  and a second component of  $-5/2$ .

**2.2 Example** Reduction of a linear system can end with more than one variable free. On this system Gauss' method

$$\begin{array}{rcl}
 x + y + z - w = 1 & & x + y + z - w = 1 \\
 y - z + w = -1 & \xrightarrow{-3\rho_1 + \rho_3} & y - z + w = -1 \\
 3x + 6z - 6w = 6 & & -3y + 3z - 3w = 3 \\
 -y + z - w = 1 & & -y + z - w = 1 \\
 & & x + y + z - w = 1 \\
 & \xrightarrow{\substack{3\rho_2 + \rho_3 \\ \rho_2 + \rho_4}} & y - z + w = -1 \\
 & & 0 = 0 \\
 & & 0 = 0
 \end{array}$$

leaves  $x$  and  $y$  leading, and both  $z$  and  $w$  free. To get the description that we prefer we work from the bottom. We first express the leading variable  $y$  in terms of  $z$  and  $w$ , with  $y = -1 + z - w$ . Moving up to the top equation, substituting for  $y$  gives  $x + (-1 + z - w) + z - w = 1$  and solving for  $x$  leaves  $x = 2 - 2z + 2w$ . The solution set

$$\{(2 - 2z + 2w, -1 + z - w, z, w) \mid z, w \in \mathbb{R}\} \quad (**)$$

has the leading variables in terms of the others.

The advantage of the descriptions (\*) and (\*\*) is that the variables can be any real number. This makes the job of deciding which tuples are in the solution set into an easy one. For instance, in the prior example taking  $z = 1$  and  $w = 2$  gives the solution  $(4, -2, 1, 2)$ . In contrast,  $(3, -2, 1, 2)$  is not a solution since the first component of any solution must be 2 minus twice the third component plus twice the fourth.

**2.3 Example** The leading variables need not be the first ones. After this reduction

$$\begin{array}{rcl}
 2x - 2y = 0 & & 2x - 2y = 0 \\
 z + 3w = 2 & \xrightarrow{-(3/2)\rho_1 + \rho_3} & z + 3w = 2 \\
 3x - 3y = 0 & \xrightarrow{-(1/2)\rho_1 + \rho_4} & 0 = 0 \\
 x - y + 2z + 6w = 4 & & 2z + 6w = 4 \\
 & & 2x - 2y = 0 \\
 & \xrightarrow{-2\rho_2 + \rho_4} & z + 3w = 2 \\
 & & 0 = 0 \\
 & & 0 = 0
 \end{array}$$

$x$  and  $z$  lead. The solution set, described with the non-leading variables, is  $\{(y, y, 2 - 3w, w) \mid y, w \in \mathbb{R}\}$ . For instance,  $(1, 1, 2, 0)$  satisfies the system — take  $y = 1$  and  $w = 0$ . The four-tuple  $(1, 0, 5, 4)$  is not a solution since its first coordinate does not equal its second.

**2.4 Definition** In an echelon form linear system the variables that are not leading are *free*.



parentheses around the array are so that when two matrices are adjacent then we can tell where one ends and the next one begins.)

Matrices occur throughout this book. We shall use  $\mathcal{M}_{n \times m}$  to denote the collection of  $n \times m$  matrices.

**2.7 Example** We can abbreviate this linear system

$$\begin{array}{rcl} x + 2y & = & 4 \\ & y - z & = 0 \\ x & + 2z & = 4 \end{array}$$

with this matrix.

$$\left( \begin{array}{ccc|c} 1 & 2 & 0 & 4 \\ 0 & 1 & -1 & 0 \\ 1 & 0 & 2 & 4 \end{array} \right)$$

The vertical bar just reminds a reader of the difference between the coefficients on the system's left hand side and the constants on the right. With a bar, this is an *augmented* matrix. In this notation the clerical load of Gauss' method—the copying of variables, the writing of +'s and ='s—is lighter.

$$\left( \begin{array}{ccc|c} 1 & 2 & 0 & 4 \\ 0 & 1 & -1 & 0 \\ 1 & 0 & 2 & 4 \end{array} \right) \xrightarrow{-\rho_1 + \rho_3} \left( \begin{array}{ccc|c} 1 & 2 & 0 & 4 \\ 0 & 1 & -1 & 0 \\ 0 & -2 & 2 & 0 \end{array} \right) \xrightarrow{2\rho_2 + \rho_3} \left( \begin{array}{ccc|c} 1 & 2 & 0 & 4 \\ 0 & 1 & -1 & 0 \\ 0 & 0 & 0 & 0 \end{array} \right)$$

The second row stands for  $y - z = 0$  and the first row stands for  $x + 2y = 4$  so the solution set is  $\{(4 - 2z, z, z) \mid z \in \mathbb{R}\}$ .

We will also use the matrix notation to clarify the descriptions of solution sets. The description  $\{(2 - 2z + 2w, -1 + z - w, z, w) \mid z, w \in \mathbb{R}\}$  from Example 2.2 is hard to read. We will rewrite it to group all the constants together, all the coefficients of  $z$  together, and all the coefficients of  $w$  together. We will write them vertically, in one-column matrices.

$$\left\{ \begin{pmatrix} 2 \\ -1 \\ 0 \\ 0 \end{pmatrix} + \begin{pmatrix} -2 \\ 1 \\ 1 \\ 0 \end{pmatrix} \cdot z + \begin{pmatrix} 2 \\ -1 \\ 0 \\ 1 \end{pmatrix} \cdot w \mid z, w \in \mathbb{R} \right\}$$

For instance, the top line says that  $x = 2 - 2z + 2w$  and the second line says that  $y = -1 + z - w$ . The next section gives a geometric interpretation that will help us picture the solution sets.

**2.8 Definition** A *vector* (or *column vector*) is a matrix with a single column. A matrix with a single row is a *row vector*. The entries of a vector are its *components*.

Vectors are an exception to the convention of representing matrices with capital roman letters. We use lower-case roman or greek letters overlined with an



arrow:  $\vec{a}$ ,  $\vec{b}$ , ... or  $\vec{\alpha}$ ,  $\vec{\beta}$ , ... (boldface is also common:  $\mathbf{a}$  or  $\mathbf{\alpha}$ ). For instance, this is a column vector with a third component of 7.

$$\vec{v} = \begin{pmatrix} 1 \\ 3 \\ 7 \end{pmatrix}$$

**2.9 Definition** The linear equation  $a_1x_1 + a_2x_2 + \cdots + a_nx_n = d$  with unknowns  $x_1, \dots, x_n$  is *satisfied* by

$$\vec{s} = \begin{pmatrix} s_1 \\ \vdots \\ s_n \end{pmatrix}$$

if  $a_1s_1 + a_2s_2 + \cdots + a_ns_n = d$ . A vector satisfies a linear system if it satisfies each equation in the system.

The style of description of solution sets that we use involves adding the vectors, and also multiplying them by real numbers, such as the  $z$  and  $w$ . We need to define these operations.

**2.10 Definition** The *vector sum* of  $\vec{u}$  and  $\vec{v}$  is the vector of the sums.

$$\vec{u} + \vec{v} = \begin{pmatrix} u_1 \\ \vdots \\ u_n \end{pmatrix} + \begin{pmatrix} v_1 \\ \vdots \\ v_n \end{pmatrix} = \begin{pmatrix} u_1 + v_1 \\ \vdots \\ u_n + v_n \end{pmatrix}$$

Note that the vectors must have the same number of entries for the addition to be defined. This entry-by-entry addition works for any pair of matrices, not just vectors, provided that they have the same number of rows and columns.

**2.11 Definition** The *scalar multiplication* of the real number  $r$  and the vector  $\vec{v}$  is the vector of the multiples.

$$r \cdot \vec{v} = r \cdot \begin{pmatrix} v_1 \\ \vdots \\ v_n \end{pmatrix} = \begin{pmatrix} rv_1 \\ \vdots \\ rv_n \end{pmatrix}$$

As with the addition operation, the entry-by-entry scalar multiplication operation extends beyond just vectors to any matrix.

We write scalar multiplication in either order, as  $r \cdot \vec{v}$  or  $\vec{v} \cdot r$ , or without the ‘ $\cdot$ ’ symbol:  $r\vec{v}$ . (Do not refer to scalar multiplication as ‘scalar product’ because we use that name for a different operation.)

**2.12 Example**

$$\begin{pmatrix} 2 \\ 3 \\ 1 \end{pmatrix} + \begin{pmatrix} 3 \\ -1 \\ 4 \end{pmatrix} = \begin{pmatrix} 2+3 \\ 3-1 \\ 1+4 \end{pmatrix} = \begin{pmatrix} 5 \\ 2 \\ 5 \end{pmatrix} \quad 7 \cdot \begin{pmatrix} 1 \\ 4 \\ -1 \\ -3 \end{pmatrix} = \begin{pmatrix} 7 \\ 28 \\ -7 \\ -21 \end{pmatrix}$$

Notice that the definitions of vector addition and scalar multiplication agree where they overlap, for instance,  $\vec{v} + \vec{v} = 2\vec{v}$ .

With the notation defined, we can now solve systems in the way that we will use from now on.

**2.13 Example** This system

$$\begin{array}{rclcrcl} 2x + y & - & w & = & 4 & \\ & & y & + & w + u & = & 4 \\ x & - & z + 2w & = & 0 & \end{array}$$

reduces in this way.

$$\begin{array}{c} \left( \begin{array}{ccccc|c} 2 & 1 & 0 & -1 & 0 & 4 \\ 0 & 1 & 0 & 1 & 1 & 4 \\ 1 & 0 & -1 & 2 & 0 & 0 \end{array} \right) \xrightarrow{-(1/2)\rho_1 + \rho_3} \left( \begin{array}{ccccc|c} 2 & 1 & 0 & -1 & 0 & 4 \\ 0 & 1 & 0 & 1 & 1 & 4 \\ 0 & -1/2 & -1 & 5/2 & 0 & -2 \end{array} \right) \\ \xrightarrow{(1/2)\rho_2 + \rho_3} \left( \begin{array}{ccccc|c} 2 & 1 & 0 & -1 & 0 & 4 \\ 0 & 1 & 0 & 1 & 1 & 4 \\ 0 & 0 & -1 & 3 & 1/2 & 0 \end{array} \right) \end{array}$$

The solution set is  $\{(w + (1/2)u, 4 - w - u, 3w + (1/2)u, w, u) \mid w, u \in \mathbb{R}\}$ . We write that in vector form.

$$\left\{ \begin{pmatrix} x \\ y \\ z \\ w \\ u \end{pmatrix} = \begin{pmatrix} 0 \\ 4 \\ 0 \\ 0 \\ 0 \end{pmatrix} + \begin{pmatrix} 1 \\ -1 \\ 3 \\ 1 \\ 0 \end{pmatrix} w + \begin{pmatrix} 1/2 \\ -1 \\ 1/2 \\ 0 \\ 1 \end{pmatrix} u \mid w, u \in \mathbb{R} \right\}$$

Note how well vector notation sets off the coefficients of each parameter. For instance, the third row of the vector form shows plainly that if  $u$  is fixed then  $z$  increases three times as fast as  $w$ . Another thing shown plainly is that setting both  $w$  and  $u$  to zero gives that this vector

$$\begin{pmatrix} x \\ y \\ z \\ w \\ u \end{pmatrix} = \begin{pmatrix} 0 \\ 4 \\ 0 \\ 0 \\ 0 \end{pmatrix}$$

is a particular solution of the linear system.

**2.14 Example** In the same way, this system

$$\begin{array}{rcl} x - y + z & = & 1 \\ 3x & + & z = 3 \\ 5x - 2y + 3z & = & 5 \end{array}$$

reduces

$$\left( \begin{array}{ccc|c} 1 & -1 & 1 & 1 \\ 3 & 0 & 1 & 3 \\ 5 & -2 & 3 & 5 \end{array} \right) \xrightarrow{\begin{array}{l} -3\rho_1 + \rho_2 \\ -5\rho_1 + \rho_3 \end{array}} \left( \begin{array}{ccc|c} 1 & -1 & 1 & 1 \\ 0 & 3 & -2 & 0 \\ 0 & 3 & -2 & 0 \end{array} \right) \xrightarrow{-\rho_2 + \rho_3} \left( \begin{array}{ccc|c} 1 & -1 & 1 & 1 \\ 0 & 3 & -2 & 0 \\ 0 & 0 & 0 & 0 \end{array} \right)$$

to a one-parameter solution set.

$$\left\{ \begin{pmatrix} 1 \\ 0 \\ 0 \end{pmatrix} + \begin{pmatrix} -1/3 \\ 2/3 \\ 1 \end{pmatrix} z \mid z \in \mathbb{R} \right\}$$

As in the prior example, the vector not associated with the parameter

$$\begin{pmatrix} 1 \\ 0 \\ 0 \end{pmatrix}$$

is a particular solution of the system.

Before the exercises, we will consider what we have accomplished and what we have yet to do.

So far we have done the mechanics of Gauss' method. Except for one result, Theorem 1.5—which we did because it says that the method gives the right answers—we have not stopped to consider any of the interesting questions that arise.

For example, can we prove that we can always describe solution sets as above, with a particular solution vector added to an unrestricted linear combination of some other vectors? We've noted that the solution sets we described in this way have infinitely many solutions so an answer to this question would tell us about the size of solution sets. It will also help us understand the geometry of the solution sets.

Many questions arise from our observation that we can do Gauss' method in more than one way (for instance, when swapping rows we may have a choice of more than one row). Theorem 1.5 says that we must get the same solution set no matter how we proceed but if we do Gauss' method in two ways must we get the same number of free variables in each echelon form system? Must those be the same variables, that is, is solving a problem one way to get  $y$  and  $w$  free and solving it another way to get  $y$  and  $z$  free impossible?

In the rest of this chapter we will answer these questions. The answer to each is 'yes'. We do the first one, the proof about the description of solution sets, in the next subsection. Then, in the chapter's second section, we will describe the geometry of solution sets. After that, in this chapter's final section, we will settle the questions about the parameters. When we are done we will not only have a solid grounding in the practice of Gauss' method, we will also have a solid grounding in the theory. We will know exactly what can and cannot happen in a reduction.

### Exercises

✓ 2.15 Find the indicated entry of the matrix, if it is defined.

$$A = \begin{pmatrix} 1 & 3 & 1 \\ 2 & -1 & 4 \end{pmatrix}$$

(a)  $a_{2,1}$    (b)  $a_{1,2}$    (c)  $a_{2,2}$    (d)  $a_{3,1}$

✓ 2.16 Give the size of each matrix.

(a)  $\begin{pmatrix} 1 & 0 & 4 \\ 2 & 1 & 5 \end{pmatrix}$    (b)  $\begin{pmatrix} 1 & 1 \\ -1 & 1 \\ 3 & -1 \end{pmatrix}$    (c)  $\begin{pmatrix} 5 & 10 \\ 10 & 5 \end{pmatrix}$

✓ 2.17 Do the indicated vector operation, if it is defined.

(a)  $\begin{pmatrix} 2 \\ 1 \\ 1 \end{pmatrix} + \begin{pmatrix} 3 \\ 0 \\ 4 \end{pmatrix}$    (b)  $5 \begin{pmatrix} 4 \\ -1 \end{pmatrix}$    (c)  $\begin{pmatrix} 1 \\ 5 \\ 1 \end{pmatrix} - \begin{pmatrix} 3 \\ 1 \\ 1 \end{pmatrix}$    (d)  $7 \begin{pmatrix} 2 \\ 1 \end{pmatrix} + 9 \begin{pmatrix} 3 \\ 5 \end{pmatrix}$

(e)  $\begin{pmatrix} 1 \\ 2 \end{pmatrix} + \begin{pmatrix} 1 \\ 2 \\ 3 \end{pmatrix}$    (f)  $6 \begin{pmatrix} 3 \\ 1 \\ 1 \end{pmatrix} - 4 \begin{pmatrix} 2 \\ 0 \\ 3 \end{pmatrix} + 2 \begin{pmatrix} 1 \\ 1 \\ 5 \end{pmatrix}$

✓ 2.18 Solve each system using matrix notation. Express the solution using vectors.

(a)  $3x + 6y = 18$    (b)  $x + y = 1$    (c)  $x_1 + x_3 = 4$   
 $x + 2y = 6$     $x - y = -1$     $x_1 - x_2 + 2x_3 = 5$   
 $4x_1 - x_2 + 5x_3 = 17$

(d)  $2a + b - c = 2$    (e)  $x + 2y - z = 3$    (f)  $x + z + w = 4$   
 $2a + c = 3$     $2x + y + w = 4$     $2x + y - w = 2$   
 $a - b = 0$     $x - y + z + w = 1$     $3x + y + z = 7$

✓ 2.19 Solve each system using matrix notation. Give each solution set in vector notation.

(a)  $2x + y - z = 1$    (b)  $x - z = 1$    (c)  $x - y + z = 0$   
 $4x - y = 3$     $y + 2z - w = 3$     $y + w = 0$   
 $x + 2y + 3z - w = 7$     $3x - 2y + 3z + w = 0$   
 $-y - w = 0$

(d)  $a + 2b + 3c + d - e = 1$   
 $3a - b + c + d + e = 3$

✓ 2.20 The vector is in the set. What value of the parameters produces that vector?

(a)  $\begin{pmatrix} 5 \\ -5 \end{pmatrix}, \left\{ \begin{pmatrix} 1 \\ -1 \end{pmatrix} k \mid k \in \mathbb{R} \right\}$

(b)  $\begin{pmatrix} -1 \\ 2 \\ 1 \end{pmatrix}, \left\{ \begin{pmatrix} -2 \\ 1 \\ 0 \end{pmatrix} i + \begin{pmatrix} 3 \\ 0 \\ 1 \end{pmatrix} j \mid i, j \in \mathbb{R} \right\}$

(c)  $\begin{pmatrix} 0 \\ -4 \\ 2 \end{pmatrix}, \left\{ \begin{pmatrix} 1 \\ 1 \\ 0 \end{pmatrix} m + \begin{pmatrix} 2 \\ 0 \\ 1 \end{pmatrix} n \mid m, n \in \mathbb{R} \right\}$

2.21 Decide if the vector is in the set.

(a)  $\begin{pmatrix} 3 \\ -1 \end{pmatrix}, \left\{ \begin{pmatrix} -6 \\ 2 \end{pmatrix} k \mid k \in \mathbb{R} \right\}$

(b)  $\begin{pmatrix} 5 \\ 4 \end{pmatrix}, \left\{ \begin{pmatrix} 5 \\ -4 \end{pmatrix} j \mid j \in \mathbb{R} \right\}$

(c)  $\begin{pmatrix} 2 \\ 1 \\ -1 \end{pmatrix}, \left\{ \begin{pmatrix} 0 \\ 3 \\ -7 \end{pmatrix} + \begin{pmatrix} 1 \\ -1 \\ 3 \end{pmatrix} r \mid r \in \mathbb{R} \right\}$

(d)  $\begin{pmatrix} 1 \\ 0 \\ 1 \end{pmatrix}, \left\{ \begin{pmatrix} 2 \\ 0 \\ 1 \end{pmatrix} j + \begin{pmatrix} -3 \\ -1 \\ 1 \end{pmatrix} k \mid j, k \in \mathbb{R} \right\}$

2.22 [Cleary] A farmer with 1200 acres is considering planting three different crops, corn, soybeans, and oats. The farmer wants to use all 1200 acres. Seed corn costs \$20 per acre, while soybean and oat seed cost \$50 and \$12 per acre respectively. The farmer has \$40 000 available to buy seed and intends to spend it all.

- Use the information above to formulate two linear equations with three unknowns and solve it.
- Solutions to the system are choices that the farmer can make. Write down two reasonable solutions.
- Suppose that in the fall when the crops mature, the farmer can bring in revenue of \$100 per acre for corn, \$300 per acre for soybeans and \$80 per acre for oats. Which of your two solutions in the prior part would have resulted in a larger revenue?

2.23 Parametrize the solution set of this one-equation system.

$$x_1 + x_2 + \cdots + x_n = 0$$

- ✓ 2.24 (a) Apply Gauss' method to the left-hand side to solve

$$\begin{array}{rcl} x + 2y & - & w = a \\ 2x & + & z = b \\ x + y & + & 2w = c \end{array}$$

for  $x$ ,  $y$ ,  $z$ , and  $w$ , in terms of the constants  $a$ ,  $b$ , and  $c$ .

- (b) Use your answer from the prior part to solve this.

$$\begin{array}{rcl} x + 2y & - & w = 3 \\ 2x & + & z = 1 \\ x + y & + & 2w = -2 \end{array}$$

- ✓ 2.25 Why is the comma needed in the notation ' $a_{i,j}$ ' for matrix entries?

- ✓ 2.26 Give the  $4 \times 4$  matrix whose  $i, j$ -th entry is

- (a)  $i + j$ ; (b)  $-1$  to the  $i + j$  power.

2.27 For any matrix  $A$ , the *transpose* of  $A$ , written  $A^{\text{trans}}$ , is the matrix whose columns are the rows of  $A$ . Find the transpose of each of these.

(a)  $\begin{pmatrix} 1 & 2 & 3 \\ 4 & 5 & 6 \end{pmatrix}$  (b)  $\begin{pmatrix} 2 & -3 \\ 1 & 1 \end{pmatrix}$  (c)  $\begin{pmatrix} 5 & 10 \\ 10 & 5 \end{pmatrix}$  (d)  $\begin{pmatrix} 1 \\ 1 \\ 0 \end{pmatrix}$

- ✓ 2.28 (a) Describe all functions  $f(x) = ax^2 + bx + c$  such that  $f(1) = 2$  and  $f(-1) = 6$ .

- (b) Describe all functions  $f(x) = ax^2 + bx + c$  such that  $f(1) = 2$ .

2.29 Show that any set of five points from the plane  $\mathbb{R}^2$  lie on a common conic section, that is, they all satisfy some equation of the form  $ax^2 + by^2 + cxy + dx + ey + f = 0$  where some of  $a, \dots, f$  are nonzero.

2.30 Make up a four equations/four unknowns system having

- a one-parameter solution set;
- a two-parameter solution set;
- a three-parameter solution set.

- ? 2.31 [Shepelev] This puzzle is from a Russian web-site <http://www.arbuz.uz/>, and there are many solutions to it, but mine uses linear algebra and is very naive. There's a planet inhabited by arbuzoids (watermelons, if to translate from Russian). Those creatures are found in three colors: red, green and blue. There are 13 red arbuzoids, 15 blue ones, and 17 green. When two differently colored arbuzoids meet, they both change to the third color.

The question is, can it ever happen that all of them assume the same color?

? 2.32 [USSR Olympiad no. 174]

(a) Solve the system of equations.

$$\begin{aligned} ax + y &= a^2 \\ x + ay &= 1 \end{aligned}$$

For what values of  $a$  does the system fail to have solutions, and for what values of  $a$  are there infinitely many solutions?

(b) Answer the above question for the system.

$$\begin{aligned} ax + y &= a^3 \\ x + ay &= 1 \end{aligned}$$

? 2.33 [Math. Mag., Sept. 1952] In air a gold-surfaced sphere weighs 7588 grams. It is known that it may contain one or more of the metals aluminum, copper, silver, or lead. When weighed successively under standard conditions in water, benzene, alcohol, and glycerin its respective weights are 6588, 6688, 6778, and 6328 grams. How much, if any, of the forenamed metals does it contain if the specific gravities of the designated substances are taken to be as follows?

Aluminum	2.7	Alcohol	0.81
Copper	8.9	Benzene	0.90
Gold	19.3	Glycerin	1.26
Lead	11.3	Water	1.00
Silver	10.8		

### I.3 General = Particular + Homogeneous

In the prior subsection the descriptions of solution sets all fit a pattern. They have a vector that is a particular solution of the system added to an unrestricted combination of some other vectors. The solution set from Example 2.13 illustrates.

$$\left\{ \underbrace{\begin{pmatrix} 0 \\ 4 \\ 0 \\ 0 \\ 0 \end{pmatrix}}_{\text{particular solution}} + w \underbrace{\begin{pmatrix} 1 \\ -1 \\ 3 \\ 1 \\ 0 \end{pmatrix}}_{\text{unrestricted combination}} + u \begin{pmatrix} 1/2 \\ -1 \\ 1/2 \\ 0 \\ 1 \end{pmatrix} \mid w, u \in \mathbb{R} \right\}$$

The combination is unrestricted in that  $w$  and  $u$  can be any real numbers—there is no condition like “such that  $2w - u = 0$ ” that would restrict which pairs  $w, u$  we can use.

That example shows an infinite solution set fitting the pattern. The other two kinds of solution sets also fit. A one-element solution set fits because it has a particular solution and the unrestricted combination part is trivial. (That is, instead of being a combination of two vectors or of one vector, it is a combination of no vectors. We are using the convention that the sum of an empty set of vectors is the vector of all zeros.) A zero-element solution set fits the pattern because there is no particular solution and so there are no sums of that form.

**3.1 Theorem** Any linear system's solution set has the form

$$\{\vec{p} + c_1\vec{\beta}_1 + \cdots + c_k\vec{\beta}_k \mid c_1, \dots, c_k \in \mathbb{R}\}$$

where  $\vec{p}$  is any particular solution and where the number of vectors  $\vec{\beta}_1, \dots, \vec{\beta}_k$  equals the number of free variables that the system has after a Gaussian reduction.

The solution description has two parts, the particular solution  $\vec{p}$  and the unrestricted linear combination of the  $\vec{\beta}$ 's. We shall prove the theorem in two corresponding parts, with two lemmas.

We will focus first on the unrestricted combination. For that we consider systems that have the vector of zeroes as a particular solution so that we can shorten  $\vec{p} + c_1\vec{\beta}_1 + \cdots + c_k\vec{\beta}_k$  to  $c_1\vec{\beta}_1 + \cdots + c_k\vec{\beta}_k$ .

**3.2 Definition** A linear equation is *homogeneous* if it has a constant of zero, so it can be put in the form  $a_1x_1 + a_2x_2 + \cdots + a_nx_n = 0$ .

**3.3 Example** With any linear system like

$$\begin{aligned} 3x + 4y &= 3 \\ 2x - y &= 1 \end{aligned}$$

we associate a system of homogeneous equations by setting the right side to zeros.

$$\begin{aligned} 3x + 4y &= 0 \\ 2x - y &= 0 \end{aligned}$$

Our interest in this comes from comparing the reduction of the original system

$$\begin{array}{r} 3x + 4y = 3 \\ 2x - y = 1 \end{array} \xrightarrow{-(2/3)\rho_1 + \rho_2} \begin{array}{r} 3x + 4y = 3 \\ -(11/3)y = -1 \end{array}$$

with the reduction of the associated homogeneous system.

$$\begin{array}{r} 3x + 4y = 0 \\ 2x - y = 0 \end{array} \xrightarrow{-(2/3)\rho_1 + \rho_2} \begin{array}{r} 3x + 4y = 0 \\ -(11/3)y = 0 \end{array}$$

Obviously the two reductions go in the same way. We can study how to reduce a linear systems by instead studying how to reduce the associated homogeneous system.

Studying the associated homogeneous system has a great advantage over studying the original system. Nonhomogeneous systems can be inconsistent. But a homogeneous system must be consistent since there is always at least one solution, the vector of zeros.

**3.4 Definition** A column or row vector of all zeros is a *zero vector*, denoted  $\vec{0}$ .

There are many different zero vectors, e.g., the one-tall zero vector, the two-tall zero vector, etc. Nonetheless we will usually say “the” zero vector, expecting that the size will be clear from the context.

**3.5 Example** Some homogeneous systems have the zero vector as their only solution.

$$\begin{array}{rcl} 3x + 2y + z = 0 & & 3x + 2y + z = 0 \\ 6x + 4y = 0 & \xrightarrow{-2\rho_1 + \rho_2} & -2z = 0 \\ y + z = 0 & & y + z = 0 \end{array} \quad \begin{array}{rcl} 3x + 2y + z = 0 & & 3x + 2y + z = 0 \\ -2z = 0 & \xrightarrow{\rho_2 \leftrightarrow \rho_3} & y + z = 0 \\ y + z = 0 & & -2z = 0 \end{array}$$

**3.6 Example** Some homogeneous systems have many solutions. One example is the Chemistry problem from the first page of this book.

$$\begin{array}{rcl} 7x & -7z & = 0 \\ 8x + y - 5z - 2w = 0 & \xrightarrow{-(8/7)\rho_1 + \rho_2} & y + 3z - 2w = 0 \\ y - 3z = 0 & & y - 3z = 0 \\ 3y - 6z - w = 0 & & 3y - 6z - w = 0 \end{array} \quad \begin{array}{rcl} 7x & -7z & = 0 \\ y + 3z - 2w = 0 & & y + 3z - 2w = 0 \\ -6z + 2w = 0 & & -6z + 2w = 0 \\ -15z + 5w = 0 & & -15z + 5w = 0 \end{array}$$

$$\begin{array}{rcl} 7x & -7z & = 0 \\ y + 3z - 2w = 0 & \xrightarrow{-\rho_2 + \rho_3} & y + 3z - 2w = 0 \\ -6z + 2w = 0 & \xrightarrow{-3\rho_2 + \rho_4} & -6z + 2w = 0 \\ -15z + 5w = 0 & & -15z + 5w = 0 \end{array} \quad \begin{array}{rcl} 7x & -7z & = 0 \\ y + 3z - 2w = 0 & \xrightarrow{-(5/2)\rho_3 + \rho_4} & y + 3z - 2w = 0 \\ -6z + 2w = 0 & & -6z + 2w = 0 \\ 0 = 0 & & 0 = 0 \end{array}$$

The solution set

$$\left\{ \begin{pmatrix} 1/3 \\ 1 \\ 1/3 \\ 1 \end{pmatrix} w \mid w \in \mathbb{R} \right\}$$

has many vectors besides the zero vector (if we interpret  $w$  as a number of molecules then solutions make sense only when  $w$  is a nonnegative multiple of 3).

**3.7 Lemma** For any homogeneous linear system there exist vectors  $\vec{\beta}_1, \dots, \vec{\beta}_k$  such that the solution set of the system is

$$\{ c_1 \vec{\beta}_1 + \dots + c_k \vec{\beta}_k \mid c_1, \dots, c_k \in \mathbb{R} \}$$

where  $k$  is the number of free variables in an echelon form version of the system.



Before the proof, recall how back substitution happens. Imagine that we have brought a system to this echelon form.

$$\begin{array}{rcl} x + 2y - z + 2w & = & 0 \\ -3y + z & = & 0 \\ -w & = & 0 \end{array}$$

Working from the bottom, we first get that  $w$  is  $0 \cdot z$ , then that  $y$  is  $(1/3) \cdot z$ , and then substituting those two back into the top equation  $x + 2((1/3)z) - z + 2(0) = 0$  gives  $x = (1/3) \cdot z$ . So, back substitution gives a parametrization of the solution set by starting at the bottom equation and using the free variables as the parameters to work row-by-row to the top. The proof below follows this pattern.

That is, this proof simply checks the bookkeeping to show that back substitution can't fail, say, by leading to a division by zero. So the argument below, while detailed, doesn't give us any new insights. Nevertheless, we have written it out for two reasons. One is that we need to be sure that the computational procedure works. The other is that the row-by-row nature of back substitution leads naturally to a proof by mathematical induction.\* This is an important and non-obvious proof style that we shall use a number of times.

Mathematical induction has two steps, a base step and an inductive step. In the base step here will focus only on the bottom-most non-' $0 = 0$ ' equation, and show that we can write its leading variable in terms of its other variables. Then the inductive step will be to argue that if we can express the leading variables from the bottom-most  $t$  rows in terms of the free variables then we can express the leading variable of the next row up—the  $t + 1$ -th row from the bottom—in terms of the free variables. Those two steps together prove the theorem because by the base step the theorem is true for the bottom equation, and by the inductive step the fact that it is true for the bottom equation shows that it is true for the next one up, and then another application of the inductive step implies that it is true for the third equation up, etc.

PROOF Apply Gauss' method to get to echelon form. We may get some ' $0 = 0$ ' equations (if the entire system consists of such equations then the theorem is trivially true) but because the system is homogeneous we cannot get any contradictory equations. We will argue by induction that each leading variable can be expressed in terms of free variables. That will prove the result because we can use those free variables as the parameters, so the  $\vec{\beta}$ 's are the vectors of coefficients of the free variables (as in Example 3.6).

For the base step, consider the bottom-most equation. Call it equation  $m$

$$a_{m,\ell_m} x_{\ell_m} + a_{m,\ell_m+1} x_{\ell_m+1} + \cdots + a_{m,n} x_n = 0$$

where  $a_{m,\ell_m} \neq 0$ . (The ' $\ell$ ' stands for 'leading' so that  $a_{m,\ell_m}$  means "the coefficient from the row  $m$  of the variable leading row  $m$ ." ) Either there are variables in this equation other than the leading one  $x_{\ell_m}$  or else there are not.

---

\* More information on mathematical induction is in the appendix.

If there are other variables  $x_{\ell_m+1}$ , etc., then they must be free variables of the system because this is the bottom row. Move these to the right and divide by  $a_{m,\ell_m}$

$$x_{\ell_m} = (-a_{m,\ell_m+1}/a_{m,\ell_m})x_{\ell_m+1} + \cdots + (-a_{m,n}/a_{m,\ell_m})x_n$$

to express the leading variable in terms of the free variables. If there are no free variables in this equation then  $x_{\ell_m} = 0$  (see the “tricky point” following this proof).

For the inductive step we assume that for the  $m$ -th equation, and for the  $(m-1)$ -th equation,  $\dots$ , up to and including the  $(m-t)$ -th equation (where  $0 \leq t < m$ ), we can express the leading variable in terms of free variables. To prove that the same is true for the next equation up, the  $(m-(t+1))$ -th equation, we take each variable that leads in a lower-down equation  $x_{\ell_m}, \dots, x_{\ell_{m-t}}$  and substitute its expression in terms of free variables. The result has the form

$$a_{m-(t+1),\ell_{m-(t+1)}}x_{\ell_{m-(t+1)}} + \text{sums of multiples of free variables} = 0$$

where  $a_{m-(t+1),\ell_{m-(t+1)}} \neq 0$ . Move the free variables to the right-hand side (again see the “tricky point”) and divide by  $a_{m-(t+1),\ell_{m-(t+1)}}$  to end with  $x_{\ell_{m-(t+1)}}$  expressed in terms of free variables.

Because we have shown both the base step and the inductive step, by the principle of mathematical induction the proposition is true. QED

We say that the set  $\{c_1\vec{\beta}_1 + \cdots + c_k\vec{\beta}_k \mid c_1, \dots, c_k \in \mathbb{R}\}$  is *generated by* or *spanned by* the set of vectors  $\{\vec{\beta}_1, \dots, \vec{\beta}_k\}$ .

There is a tricky point to this. We rely on the convention that the sum of an empty set of vectors is the zero vector. In particular, we need this in the case where a homogeneous system has a unique solution. Then the homogeneous case fits the pattern of the other solution sets: in the proof above, we derive the solution set by taking the  $c$ 's to be the free variables and if there is a unique solution then there are no free variables.

The proof incidentally shows, as discussed after Example 2.3, that we can always parametrize solution sets using the free variables.

The next lemma finishes the proof of Theorem 3.1 by considering the particular solution part of the solution set's description.

**3.8 Lemma** For a linear system, where  $\vec{p}$  is any particular solution, the solution set equals this set.

$$\{\vec{p} + \vec{h} \mid \vec{h} \text{ satisfies the associated homogeneous system}\}$$

**PROOF** We will show mutual set inclusion, that any solution to the system is in the above set and that anything in the set is a solution to the system.\*

\* More information on equality of sets is in the appendix.

For set inclusion the first way, that if a vector solves the system then it is in the set described above, assume that  $\vec{s}$  solves the system. Then  $\vec{s} - \vec{p}$  solves the associated homogeneous system since for each equation index  $i$ ,

$$\begin{aligned} a_{i,1}(s_1 - p_1) + \cdots + a_{i,n}(s_n - p_n) &= (a_{i,1}s_1 + \cdots + a_{i,n}s_n) \\ &\quad - (a_{i,1}p_1 + \cdots + a_{i,n}p_n) \\ &= d_i - d_i \\ &= 0 \end{aligned}$$

where  $p_j$  and  $s_j$  are the  $j$ -th components of  $\vec{p}$  and  $\vec{s}$ . Express  $\vec{s}$  in the required  $\vec{p} + \vec{h}$  form by writing  $\vec{s} - \vec{p}$  as  $\vec{h}$ .

For set inclusion the other way, take a vector of the form  $\vec{p} + \vec{h}$ , where  $\vec{p}$  solves the system and  $\vec{h}$  solves the associated homogeneous system, and note that  $\vec{p} + \vec{h}$  solves the given system: for any equation index  $i$ ,

$$\begin{aligned} a_{i,1}(p_1 + h_1) + \cdots + a_{i,n}(p_n + h_n) &= (a_{i,1}p_1 + \cdots + a_{i,n}p_n) \\ &\quad + (a_{i,1}h_1 + \cdots + a_{i,n}h_n) \\ &= d_i + 0 \\ &= d_i \end{aligned}$$

where  $p_j$  and  $h_j$  are the  $j$ -th components of  $\vec{p}$  and  $\vec{h}$ . QED

The two lemmas above together establish Theorem 3.1. We remember that theorem with the slogan, “General = Particular + Homogeneous”.

**3.9 Example** This system illustrates Theorem 3.1.

$$\begin{aligned} x + 2y - z &= 1 \\ 2x + 4y &= 2 \\ y - 3z &= 0 \end{aligned}$$

Gauss' method

$$\begin{array}{rcl} x + 2y - z = 1 & & x + 2y - z = 1 \\ \xrightarrow{-2\rho_1 + \rho_2} & & \xrightarrow{\rho_2 \leftrightarrow \rho_3} \\ \begin{array}{l} 2z = 0 \\ y - 3z = 0 \end{array} & & \begin{array}{l} y - 3z = 0 \\ 2z = 0 \end{array} \end{array}$$

shows that the general solution is a singleton set.

$$\left\{ \begin{pmatrix} 1 \\ 0 \\ 0 \end{pmatrix} \right\}$$

That single vector is obviously a particular solution. The associated homogeneous system reduces via the same row operations

$$\begin{array}{rcl} x + 2y - z = 0 & & x + 2y - z = 0 \\ 2x + 4y = 0 & & \xrightarrow{\rho_2 \leftrightarrow \rho_3} \\ \xrightarrow{-2\rho_1 + \rho_2} & & \begin{array}{l} y - 3z = 0 \\ 2z = 0 \end{array} \end{array}$$

to also give a singleton set.

$$\left\{ \begin{pmatrix} 0 \\ 0 \\ 0 \end{pmatrix} \right\}$$

So, as discussed at the start of this subsection, in this single-solution case the general solution results from taking the particular solution and adding to it the unique solution of the associated homogeneous system.

**3.10 Example** Also discussed at the start of this subsection is that the case where the general solution set is empty also fits the ‘General = Particular + Homogeneous’ pattern. This system illustrates. Gauss’ method

$$\begin{array}{rcl} x & + & z + w = -1 \\ 2x - y & & + w = 3 \\ x + y + 3z + 2w & = & 1 \end{array} \xrightarrow[\begin{smallmatrix} -2\rho_1 + \rho_2 \\ -\rho_1 + \rho_3 \end{smallmatrix}]{\begin{smallmatrix} \rho_2 + \rho_3 \\ \rho_2 + \rho_3 \end{smallmatrix}} \begin{array}{rcl} x & + & z + w = -1 \\ -y - 2z - w & = & 5 \\ y + 2z + w & = & 2 \end{array}$$

shows that it has no solutions because the final two equations are in conflict. The associated homogeneous system has a solution, because all homogeneous systems have at least one solution.

$$\begin{array}{rcl} x & + & z + w = 0 \\ 2x - y & & + w = 0 \\ x + y + 3z + 2w & = & 0 \end{array} \xrightarrow[\begin{smallmatrix} -2\rho_1 + \rho_2 \\ -\rho_1 + \rho_3 \end{smallmatrix}]{\begin{smallmatrix} \rho_2 + \rho_3 \\ \rho_2 + \rho_3 \end{smallmatrix}} \begin{array}{rcl} x & + & z + w = 0 \\ -y - 2z - w & = & 0 \\ 0 & = & 0 \end{array}$$

In fact the solution set of this homogeneous system is infinite.

$$\left\{ \begin{pmatrix} -1 \\ -2 \\ 1 \\ 0 \end{pmatrix} z + \begin{pmatrix} -1 \\ -1 \\ 0 \\ 1 \end{pmatrix} w \mid z, w \in \mathbb{R} \right\}$$

However, because no particular solution of the original system exists, the general solution set is empty — there are no vectors of the form  $\vec{p} + \vec{h}$  because there are no  $\vec{p}$ ’s.

**3.11 Corollary** Solution sets of linear systems are either empty, have one element, or have infinitely many elements.

**PROOF** We’ve seen examples of all three happening so we need only prove that there are no other possibilities.

First, notice a homogeneous system with at least one non- $\vec{0}$  solution  $\vec{v}$  has infinitely many solutions because the set of multiples  $s\vec{v}$  is infinite — if  $s \neq 1$  then  $s\vec{v} \neq \vec{v}$  because  $s\vec{v} - \vec{v} = (s - 1)\vec{v}$  is non- $\vec{0}$ , since any non-0 component of  $\vec{v}$  when rescaled by the factor  $s - 1$  will give a non-0 value.

Now, apply Lemma 3.8 to conclude that a solution set

$$\{ \vec{p} + \vec{h} \mid \vec{h} \text{ solves the associated homogeneous system} \}$$

is either empty (if there is no particular solution  $\vec{p}$ ), or has one element (if there is a  $\vec{p}$  and the homogeneous system has the unique solution  $\vec{0}$ ), or is infinite (if there is a  $\vec{p}$  and the homogeneous system has a non- $\vec{0}$  solution, and thus by the prior paragraph has infinitely many solutions). QED

This table summarizes the factors affecting the size of a general solution.

		<i>number of solutions of the homogeneous system</i>	
		<i>one</i>	<i>infinitely many</i>
<i>particular solution exists?</i>	<i>yes</i>	unique solution	infinitely many solutions
	<i>no</i>	no solutions	no solutions

The dimension on the top of the table is the simpler one. When we perform Gauss' method on a linear system, ignoring the constants on the right side and so paying attention only to the coefficients on the left-hand side, we either end with every variable leading some row or else we find that some variable does not lead a row, that is, we find that some variable is free. (We formalize "ignoring the constants on the right" by considering the associated homogeneous system.)

A notable special case is systems having the same number of equations as unknowns. Such a system will have a solution, and that solution will be unique, if and only if it reduces to an echelon form system where every variable leads its row (since there are the same number of variables as rows), which will happen if and only if the associated homogeneous system has a unique solution.

**3.12 Definition** A square matrix is *nonsingular* if it is the matrix of coefficients of a homogeneous system with a unique solution. It is *singular* otherwise, that is, if it is the matrix of coefficients of a homogeneous system with infinitely many solutions.

**3.13 Example** The first of these matrices is nonsingular while the second is singular

$$\begin{pmatrix} 1 & 2 \\ 3 & 4 \end{pmatrix} \quad \begin{pmatrix} 1 & 2 \\ 3 & 6 \end{pmatrix}$$

because the first of these homogeneous systems has a unique solution while the second has infinitely many solutions.

$$\begin{array}{ll} x + 2y = 0 & x + 2y = 0 \\ 3x + 4y = 0 & 3x + 6y = 0 \end{array}$$

We have made the distinction in the definition because a system with the same number of equations as variables behaves in one of two ways, depending on whether its matrix of coefficients is nonsingular or singular. A system where the

matrix of coefficients is nonsingular has a unique solution for any constants on the right side: for instance, Gauss' method shows that this system

$$\begin{aligned}x + 2y &= a \\ 3x + 4y &= b\end{aligned}$$

has the unique solution  $x = b - 2a$  and  $y = (3a - b)/2$ . On the other hand, a system where the matrix of coefficients is singular never has a unique solution—it has either no solutions or else has infinitely many, as with these.

$$\begin{aligned}x + 2y &= 1 & x + 2y &= 1 \\ 3x + 6y &= 2 & 3x + 6y &= 3\end{aligned}$$

The word singular means “departing from general expectation” (people often, naively, expect that systems with the same number of variables as equations will have a unique solution). Thus, we can think of it as connoting “troublesome,” or at least “not ideal.” (That ‘singular’ applies those systems that do not have one solution is ironic, but it is the standard term.)

**3.14 Example** The systems from Example 3.3, Example 3.5, and Example 3.9 each have an associated homogeneous system with a unique solution. Thus these matrices are nonsingular.

$$\begin{pmatrix} 3 & 4 \\ 2 & -1 \end{pmatrix} \quad \begin{pmatrix} 3 & 2 & 1 \\ 6 & -4 & 0 \\ 0 & 1 & 1 \end{pmatrix} \quad \begin{pmatrix} 1 & 2 & -1 \\ 2 & 4 & 0 \\ 0 & 1 & -3 \end{pmatrix}$$

The Chemistry problem from Example 3.6 is a homogeneous system with more than one solution so its matrix is singular.

$$\begin{pmatrix} 7 & 0 & -7 & 0 \\ 8 & 1 & -5 & -2 \\ 0 & 1 & -3 & 0 \\ 0 & 3 & -6 & -1 \end{pmatrix}$$

The above table has two dimensions. We have considered the one on top: we can tell into which column a given linear system goes solely by considering the system's left-hand side—the constants on the right-hand side play no role in this factor.

The table's other dimension, determining whether a particular solution exists, is tougher. Consider these two

$$\begin{aligned}3x + 2y &= 5 & 3x + 2y &= 5 \\ 3x + 2y &= 5 & 3x + 2y &= 4\end{aligned}$$

with the same left sides but different right sides. The first has a solution while the second does not, so here the constants on the right side decide if the system has a solution. We could conjecture that the left side of a linear system determines

the number of solutions while the right side determines if solutions exist but that guess is not correct. Compare these two systems

$$\begin{array}{rcl} 3x + 2y = 5 & & 3x + 2y = 5 \\ 4x + 2y = 4 & & 3x + 2y = 4 \end{array}$$

with the same right sides but different left sides. The first has a solution but the second does not. Thus the constants on the right side of a system don't decide alone whether a solution exists; rather, it depends on some interaction between the left and right sides.

For some intuition about that interaction, consider this system with one of the coefficients left as the parameter  $c$ .

$$\begin{array}{r} x + 2y + 3z = 1 \\ x + y + z = 1 \\ cx + 3y + 4z = 0 \end{array}$$

If  $c = 2$  then this system has no solution because the left-hand side has the third row as a sum of the first two, while the right-hand does not. If  $c \neq 2$  then this system has a unique solution (try it with  $c = 1$ ). For a system to have a solution, if one row of the matrix of coefficients on the left is a linear combination of other rows, then on the right the constant from that row must be the same combination of constants from the same rows.

More intuition about the interaction comes from studying linear combinations. That will be our focus in the second chapter, after we finish the study of Gauss' method itself in the rest of this chapter.

### Exercises

✓ **3.15** Solve each system. Express the solution set using vectors. Identify the particular solution and the solution set of the homogeneous system.

$$\begin{array}{lll} \text{(a)} & 3x + 6y = 18 & \text{(b)} \quad x + y = 1 \quad \text{(c)} \quad x_1 + x_3 = 4 \\ & x + 2y = 6 & \quad x - y = -1 \quad \quad x_1 - x_2 + 2x_3 = 5 \\ & & \quad \quad \quad \quad \quad \quad \quad \quad \quad \quad \quad \quad \quad \quad \quad 4x_1 - x_2 + 5x_3 = 17 \\ \text{(d)} & 2a + b - c = 2 & \text{(e)} \quad x + 2y - z = 3 \quad \text{(f)} \quad x + z + w = 4 \\ & 2a + c = 3 & \quad 2x + y + w = 4 \quad \quad 2x + y - w = 2 \\ & a - b = 0 & \quad x - y + z + w = 1 \quad \quad 3x + y + z = 7 \end{array}$$

**3.16** Solve each system, giving the solution set in vector notation. Identify the particular solution and the solution of the homogeneous system.

$$\begin{array}{lll} \text{(a)} & 2x + y - z = 1 & \text{(b)} \quad x - z = 1 \quad \text{(c)} \quad x - y + z = 0 \\ & 4x - y = 3 & \quad y + 2z - w = 3 \quad \quad y + w = 0 \\ & & \quad x + 2y + 3z - w = 7 \quad \quad 3x - 2y + 3z + w = 0 \\ & & \quad \quad \quad \quad \quad \quad \quad \quad \quad \quad \quad \quad \quad \quad \quad -y - w = 0 \end{array}$$

$$\begin{array}{l} \text{(d)} \quad a + 2b + 3c + d - e = 1 \\ \quad \quad 3a - b + c + d + e = 3 \end{array}$$

✓ **3.17** For the system

$$\begin{array}{r} 2x - y - w = 3 \\ y + z + 2w = 2 \\ x - 2y - z = -1 \end{array}$$

which of these can be used as the particular solution part of some general solution?

$$(a) \begin{pmatrix} 0 \\ -3 \\ 5 \\ 0 \end{pmatrix} \quad (b) \begin{pmatrix} 2 \\ 1 \\ 1 \\ 0 \end{pmatrix} \quad (c) \begin{pmatrix} -1 \\ -4 \\ 8 \\ -1 \end{pmatrix}$$

- ✓ 3.18 Lemma 3.8 says that we can use any particular solution for  $\vec{p}$ . Find, if possible, a general solution to this system

$$\begin{aligned} x - y + w &= 4 \\ 2x + 3y - z &= 0 \\ y + z + w &= 4 \end{aligned}$$

that uses the given vector as its particular solution.

$$(a) \begin{pmatrix} 0 \\ 0 \\ 0 \\ 4 \end{pmatrix} \quad (b) \begin{pmatrix} -5 \\ 1 \\ -7 \\ 10 \end{pmatrix} \quad (c) \begin{pmatrix} 2 \\ -1 \\ 1 \\ 1 \end{pmatrix}$$

- 3.19 One is nonsingular while the other is singular. Which is which?

$$(a) \begin{pmatrix} 1 & 3 \\ 4 & -12 \end{pmatrix} \quad (b) \begin{pmatrix} 1 & 3 \\ 4 & 12 \end{pmatrix}$$

- ✓ 3.20 Singular or nonsingular?

$$(a) \begin{pmatrix} 1 & 2 \\ 1 & 3 \end{pmatrix} \quad (b) \begin{pmatrix} 1 & 2 \\ -3 & -6 \end{pmatrix} \quad (c) \begin{pmatrix} 1 & 2 & 1 \\ 1 & 3 & 1 \end{pmatrix} \text{ (Careful!)}$$

$$(d) \begin{pmatrix} 1 & 2 & 1 \\ 1 & 1 & 3 \\ 3 & 4 & 7 \end{pmatrix} \quad (e) \begin{pmatrix} 2 & 2 & 1 \\ 1 & 0 & 5 \\ -1 & 1 & 4 \end{pmatrix}$$

- ✓ 3.21 Is the given vector in the set generated by the given set?

$$(a) \begin{pmatrix} 2 \\ 3 \end{pmatrix}, \left\{ \begin{pmatrix} 1 \\ 4 \end{pmatrix}, \begin{pmatrix} 1 \\ 5 \end{pmatrix} \right\}$$

$$(b) \begin{pmatrix} -1 \\ 0 \\ 1 \end{pmatrix}, \left\{ \begin{pmatrix} 2 \\ 1 \\ 0 \end{pmatrix}, \begin{pmatrix} 1 \\ 0 \\ 1 \end{pmatrix} \right\}$$

$$(c) \begin{pmatrix} 1 \\ 3 \\ 0 \end{pmatrix}, \left\{ \begin{pmatrix} 1 \\ 0 \\ 4 \end{pmatrix}, \begin{pmatrix} 2 \\ 1 \\ 5 \end{pmatrix}, \begin{pmatrix} 3 \\ 3 \\ 0 \end{pmatrix}, \begin{pmatrix} 4 \\ 2 \\ 1 \end{pmatrix} \right\}$$

$$(d) \begin{pmatrix} 1 \\ 0 \\ 1 \\ 1 \end{pmatrix}, \left\{ \begin{pmatrix} 2 \\ 1 \\ 0 \\ 1 \end{pmatrix}, \begin{pmatrix} 3 \\ 0 \\ 0 \\ 2 \end{pmatrix} \right\}$$

- 3.22 Prove that any linear system with a nonsingular matrix of coefficients has a solution, and that the solution is unique.

- 3.23 In the proof of Lemma 3.7, what happens if there are no non-'0 = 0' equations?

- ✓ 3.24 Prove that if  $\vec{s}$  and  $\vec{t}$  satisfy a homogeneous system then so do these vectors.

$$(a) \vec{s} + \vec{t} \quad (b) 3\vec{s} \quad (c) k\vec{s} + m\vec{t} \text{ for } k, m \in \mathbb{R}$$

What's wrong with this argument: "These three show that if a homogeneous system has one solution then it has many solutions—any multiple of a solution is another solution, and any sum of solutions is a solution also—so there are no homogeneous systems with exactly one solution."?

- 3.25 Prove that if a system with only rational coefficients and constants has a solution then it has at least one all-rational solution. Must it have infinitely many?



## II Linear Geometry

If you have seen the elements of vectors before then this section is an optional review. However, later work will refer to this material so if this is not a review then it is not optional.

In the first section, we had to do a bit of work to show that there are only three types of solution sets—singleton, empty, and infinite. But in the special case of systems with two equations and two unknowns this is easy to see with a picture. Draw each two-unknowns equation as a line in the plane and then the two lines could have a unique intersection, be parallel, or be the same line.

*Unique solution*

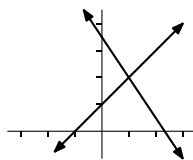

$$\begin{aligned} 3x + 2y &= 7 \\ x - y &= -1 \end{aligned}$$

*No solutions*

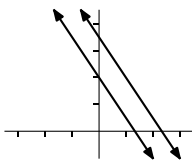

$$\begin{aligned} 3x + 2y &= 7 \\ 3x + 2y &= 4 \end{aligned}$$

*Infinitely many solutions*

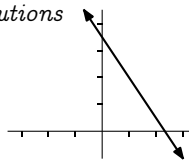

$$\begin{aligned} 3x + 2y &= 7 \\ 6x + 4y &= 14 \end{aligned}$$

These pictures aren't a short way to prove the results from the prior section, because those apply to any number of linear equations and any number of unknowns. But they do help us understand those results. This section develops the ideas that we need to express our results geometrically. In particular, while the two-dimensional case is familiar, to extend to systems with more than two unknowns we shall need some higher-dimensional geometry.

### II.1 Vectors in Space

“Higher-dimensional geometry” sounds exotic. It is exotic—interesting and eye-opening. But it isn't distant or unreachable.

We begin by defining one-dimensional space to be  $\mathbb{R}^1$ . To see that the definition is reasonable, we picture a one-dimensional space

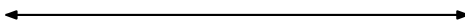

and make a correspondence with  $\mathbb{R}$  by picking a point to label 0 and another to label 1.

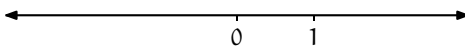

Now, with a scale and a direction, finding the point corresponding to, say,  $+2.17$ , is easy—start at 0 and head in the direction of 1, but don't stop there, go 2.17 times as far.

The basic idea here, combining magnitude with direction, is the key to extending to higher dimensions.

An object comprised of a magnitude and a direction is a *vector* (we use the same word as in the prior section because we shall show below how to describe such an object with a column vector). We can draw a vector as having some length, and pointing somewhere.



There is a subtlety here—these vectors

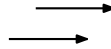

are equal, even though they start in different places, because they have equal lengths and equal directions. Again: those vectors are not just alike, they are equal.

How can things that are in different places be equal? Think of a vector as representing a displacement (the word vector is Latin for “carrier” or “traveler”). These two squares undergo equal displacements, despite that those displacements start in different places.

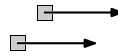

Sometimes, to emphasize this property vectors have of not being anchored, we can refer to them as *free* vectors. Thus, these free vectors are equal as each is a displacement of one over and two up.

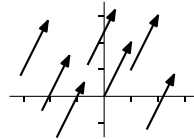

More generally, vectors in the plane are the same if and only if they have the same change in first components and the same change in second components: the vector extending from  $(a_1, a_2)$  to  $(b_1, b_2)$  equals the vector from  $(c_1, c_2)$  to  $(d_1, d_2)$  if and only if  $b_1 - a_1 = d_1 - c_1$  and  $b_2 - a_2 = d_2 - c_2$ .

Saying ‘the vector that, were it to start at  $(a_1, a_2)$ , would extend to  $(b_1, b_2)$ ’ would be unwieldy. We instead describe that vector as

$$\begin{pmatrix} b_1 - a_1 \\ b_2 - a_2 \end{pmatrix}$$

so that the ‘one over and two up’ arrows shown above picture this vector.

$$\begin{pmatrix} 1 \\ 2 \end{pmatrix}$$

We often draw the arrow as starting at the origin, and we then say it is in the *canonical position* (or *natural position* or *standard position*). When the

vector

$$\begin{pmatrix} v_1 \\ v_2 \end{pmatrix}$$

is in canonical position then it extends to the endpoint  $(v_1, v_2)$ .

We typically just refer to “the point

$$\begin{pmatrix} 1 \\ 2 \end{pmatrix}”$$

rather than “the endpoint of the canonical position of” that vector. Thus, we will call both of these sets  $\mathbb{R}^2$ .

$$\{(x_1, x_2) \mid x_1, x_2 \in \mathbb{R}\} \quad \left\{ \begin{pmatrix} x_1 \\ x_2 \end{pmatrix} \mid x_1, x_2 \in \mathbb{R} \right\}$$

In the prior section we defined vectors and vector operations with an algebraic motivation;

$$r \cdot \begin{pmatrix} v_1 \\ v_2 \end{pmatrix} = \begin{pmatrix} rv_1 \\ rv_2 \end{pmatrix} \quad \begin{pmatrix} v_1 \\ v_2 \end{pmatrix} + \begin{pmatrix} w_1 \\ w_2 \end{pmatrix} = \begin{pmatrix} v_1 + w_1 \\ v_2 + w_2 \end{pmatrix}$$

we can now understand those operations geometrically. For instance, if  $\vec{v}$  represents a displacement then  $3\vec{v}$  represents a displacement in the same direction but three times as far, and  $-\vec{v}$  represents a displacement of the same distance as  $\vec{v}$  but in the opposite direction.

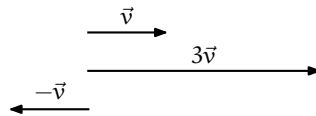

And, where  $\vec{v}$  and  $\vec{w}$  represent displacements,  $\vec{v} + \vec{w}$  represents those displacements combined.

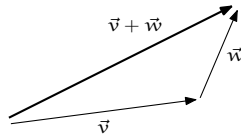

The long arrow is the combined displacement in this sense: if, in one minute, a ship’s motion gives it the displacement relative to the earth of  $\vec{v}$  and a passenger’s motion gives a displacement relative to the ship’s deck of  $\vec{w}$ , then  $\vec{v} + \vec{w}$  is the displacement of the passenger relative to the earth.

Another way to understand the vector sum is with the *parallelogram rule*. Draw the parallelogram formed by the vectors  $\vec{v}$  and  $\vec{w}$ . Then the sum  $\vec{v} + \vec{w}$  extends along the diagonal to the far corner.

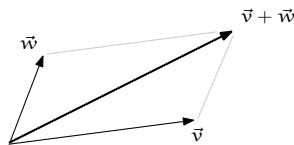

The above drawings show how vectors and vector operations behave in  $\mathbb{R}^2$ . We can extend to  $\mathbb{R}^3$ , or to even higher-dimensional spaces where we have no pictures, with the obvious generalization: the free vector that, if it starts at  $(a_1, \dots, a_n)$ , ends at  $(b_1, \dots, b_n)$ , is represented by this column.

$$\begin{pmatrix} b_1 - a_1 \\ \vdots \\ b_n - a_n \end{pmatrix}$$

Vectors are equal if they have the same representation. We aren't too careful about distinguishing between a point and the vector whose canonical representation ends at that point.

$$\mathbb{R}^n = \left\{ \begin{pmatrix} v_1 \\ \vdots \\ v_n \end{pmatrix} \mid v_1, \dots, v_n \in \mathbb{R} \right\}$$

And, we do addition and scalar multiplication component-wise.

Having considered points, we now turn to the lines. In  $\mathbb{R}^2$ , the line through  $(1, 2)$  and  $(3, 1)$  is comprised of (the endpoints of) the vectors in this set.

$$\left\{ \begin{pmatrix} 1 \\ 2 \end{pmatrix} + t \begin{pmatrix} 2 \\ -1 \end{pmatrix} \mid t \in \mathbb{R} \right\}$$

That description expresses this picture.

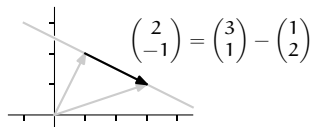

The vector associated with the parameter  $t$

$$\begin{pmatrix} 2 \\ -1 \end{pmatrix} = \begin{pmatrix} 3 \\ 1 \end{pmatrix} - \begin{pmatrix} 1 \\ 2 \end{pmatrix}$$

has its whole body in the line—it is a *direction vector* for the line. Note that points on the line to the left of  $x = 1$  are described using negative values of  $t$ .

In  $\mathbb{R}^3$ , the line through  $(1, 2, 1)$  and  $(2, 3, 2)$  is the set of (endpoints of) vectors of this form

$$\left\{ \begin{pmatrix} 1 \\ 2 \\ 1 \end{pmatrix} + t \cdot \begin{pmatrix} 1 \\ 1 \\ 1 \end{pmatrix} \mid t \in \mathbb{R} \right\}$$

A 3D coordinate system with x, y, and z axes. A line is drawn through the points (1, 2, 1) and (2, 3, 2). A vector is drawn from the point (1, 2, 1) to the point (2, 3, 2). The vector is labeled with the equation  $\begin{pmatrix} 1 \\ 2 \\ 1 \end{pmatrix} + t \cdot \begin{pmatrix} 1 \\ 1 \\ 1 \end{pmatrix}$ .

and lines in even higher-dimensional spaces work in the same way.

In  $\mathbb{R}^3$ , a line uses one parameter so that a particle on that line is free to move back and forth in one dimension, and a plane involves two parameters. For example, the plane through the points  $(1, 0, 5)$ ,  $(2, 1, -3)$ , and  $(-2, 4, 0.5)$  consists of (endpoints of) the vectors in

$$\left\{ \begin{pmatrix} 1 \\ 0 \\ 5 \end{pmatrix} + t \begin{pmatrix} 1 \\ 1 \\ -8 \end{pmatrix} + s \begin{pmatrix} -3 \\ 4 \\ -4.5 \end{pmatrix} \mid t, s \in \mathbb{R} \right\}$$

(the column vectors associated with the parameters

$$\begin{pmatrix} 1 \\ 1 \\ -8 \end{pmatrix} = \begin{pmatrix} 2 \\ 1 \\ -3 \end{pmatrix} - \begin{pmatrix} 1 \\ 0 \\ 5 \end{pmatrix} \quad \begin{pmatrix} -3 \\ 4 \\ -4.5 \end{pmatrix} = \begin{pmatrix} -2 \\ 4 \\ 0.5 \end{pmatrix} - \begin{pmatrix} 1 \\ 0 \\ 5 \end{pmatrix}$$

are two vectors whose whole bodies lie in the plane). As with the line, note that we describe some points in this plane with negative  $t$ 's or negative  $s$ 's or both.

In algebra and calculus we often use a description of planes involving a single equation as the condition that describes the relationship among the first, second, and third coordinates of points in a plane.

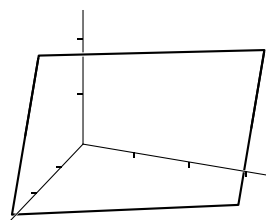

$$P = \left\{ \begin{pmatrix} x \\ y \\ z \end{pmatrix} \mid 2x + y + z = 4 \right\}$$

The translation from such a description to the vector description that we favor in this book is to think of the condition as a one-equation linear system and parametrize  $x = 2 - y/2 - z/2$ .

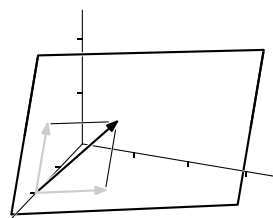

$$P = \left\{ \begin{pmatrix} x \\ y \\ z \end{pmatrix} = \begin{pmatrix} 2 \\ 0 \\ 0 \end{pmatrix} + y \cdot \begin{pmatrix} -1/2 \\ 1 \\ 0 \end{pmatrix} + z \cdot \begin{pmatrix} -1/2 \\ 0 \\ 1 \end{pmatrix} \mid y, z \in \mathbb{R} \right\}$$

Generalizing, a set of the form  $\{ \vec{p} + t_1 \vec{v}_1 + t_2 \vec{v}_2 + \cdots + t_k \vec{v}_k \mid t_1, \dots, t_k \in \mathbb{R} \}$  where  $\vec{v}_1, \dots, \vec{v}_k \in \mathbb{R}^n$  and  $k \leq n$  is a  $k$ -dimensional linear surface (or  $k$ -flat). For example, in  $\mathbb{R}^4$

$$\left\{ \begin{pmatrix} 2 \\ \pi \\ 3 \\ -0.5 \end{pmatrix} + t \begin{pmatrix} 1 \\ 0 \\ 0 \\ 0 \end{pmatrix} \mid t \in \mathbb{R} \right\}$$

is a line,

$$\left\{ \begin{pmatrix} 0 \\ 0 \\ 0 \\ 0 \end{pmatrix} + t \begin{pmatrix} 1 \\ 1 \\ 0 \\ -1 \end{pmatrix} + s \begin{pmatrix} 2 \\ 0 \\ 1 \\ 0 \end{pmatrix} \mid t, s \in \mathbb{R} \right\}$$

is a plane, and

$$\left\{ \begin{pmatrix} 3 \\ 1 \\ -2 \\ 0.5 \end{pmatrix} + r \begin{pmatrix} 0 \\ 0 \\ 0 \\ -1 \end{pmatrix} + s \begin{pmatrix} 1 \\ 0 \\ 1 \\ 0 \end{pmatrix} + t \begin{pmatrix} 2 \\ 0 \\ 1 \\ 0 \end{pmatrix} \mid r, s, t \in \mathbb{R} \right\}$$

is a three-dimensional linear surface. Again, the intuition is that a line permits motion in one direction, a plane permits motion in combinations of two directions, etc. (When the dimension of the linear surface is one less than the dimension of the space, that is, when we have an  $n - 1$ -flat in  $\mathbb{R}^n$ , then the surface is called a *hyperplane*.)

A description of a linear surface can be misleading about the dimension. For example, this

$$L = \left\{ \begin{pmatrix} 1 \\ 0 \\ -1 \\ -2 \end{pmatrix} + t \begin{pmatrix} 1 \\ 1 \\ 0 \\ -1 \end{pmatrix} + s \begin{pmatrix} 2 \\ 2 \\ 0 \\ -2 \end{pmatrix} \mid t, s \in \mathbb{R} \right\}$$

is a *degenerate* plane because it is actually a line, since the vectors are multiples of each other so we can merge the two into one.

$$L = \left\{ \begin{pmatrix} 1 \\ 0 \\ -1 \\ -2 \end{pmatrix} + r \begin{pmatrix} 1 \\ 1 \\ 0 \\ -1 \end{pmatrix} \mid r \in \mathbb{R} \right\}$$

We shall see in the Linear Independence section of Chapter Two what relationships among vectors causes the linear surface they generate to be degenerate.

We finish this subsection by restating our conclusions from earlier in geometric terms. First, the solution set of a linear system with  $n$  unknowns is a linear surface in  $\mathbb{R}^n$ . Specifically, it is a  $k$ -dimensional linear surface, where  $k$  is the number of free variables in an echelon form version of the system. Second, the solution set of a homogeneous linear system is a linear surface passing through the origin. Finally, we can view the general solution set of any linear system as being the solution set of its associated homogeneous system offset from the origin by a vector, namely by any particular solution.

### Exercises

✓ 1.1 Find the canonical name for each vector.

(a) the vector from  $(2, 1)$  to  $(4, 2)$  in  $\mathbb{R}^2$

- (b) the vector from  $(3, 3)$  to  $(2, 5)$  in  $\mathbb{R}^2$   
 (c) the vector from  $(1, 0, 6)$  to  $(5, 0, 3)$  in  $\mathbb{R}^3$   
 (d) the vector from  $(6, 8, 8)$  to  $(6, 8, 8)$  in  $\mathbb{R}^3$
- ✓ 1.2 Decide if the two vectors are equal.  
 (a) the vector from  $(5, 3)$  to  $(6, 2)$  and the vector from  $(1, -2)$  to  $(1, 1)$   
 (b) the vector from  $(2, 1, 1)$  to  $(3, 0, 4)$  and the vector from  $(5, 1, 4)$  to  $(6, 0, 7)$
- ✓ 1.3 Does  $(1, 0, 2, 1)$  lie on the line through  $(-2, 1, 1, 0)$  and  $(5, 10, -1, 4)$ ?
- ✓ 1.4 (a) Describe the plane through  $(1, 1, 5, -1)$ ,  $(2, 2, 2, 0)$ , and  $(3, 1, 0, 4)$ .  
 (b) Is the origin in that plane?
- 1.5 Describe the plane that contains this point and line.

$$\begin{pmatrix} 2 \\ 0 \\ 3 \end{pmatrix} \quad \left\{ \begin{pmatrix} -1 \\ 0 \\ -4 \end{pmatrix} + \begin{pmatrix} 1 \\ 1 \\ 2 \end{pmatrix} t \mid t \in \mathbb{R} \right\}$$

- ✓ 1.6 Intersect these planes.

$$\left\{ \begin{pmatrix} 1 \\ 1 \\ 1 \end{pmatrix} t + \begin{pmatrix} 0 \\ 1 \\ 3 \end{pmatrix} s \mid t, s \in \mathbb{R} \right\} \quad \left\{ \begin{pmatrix} 1 \\ 1 \\ 0 \end{pmatrix} + \begin{pmatrix} 0 \\ 3 \\ 0 \end{pmatrix} k + \begin{pmatrix} 2 \\ 0 \\ 4 \end{pmatrix} m \mid k, m \in \mathbb{R} \right\}$$

- ✓ 1.7 Intersect each pair, if possible.

(a)  $\left\{ \begin{pmatrix} 1 \\ 1 \\ 2 \end{pmatrix} + t \begin{pmatrix} 0 \\ 1 \\ 1 \end{pmatrix} \mid t \in \mathbb{R} \right\}, \left\{ \begin{pmatrix} 1 \\ 3 \\ -2 \end{pmatrix} + s \begin{pmatrix} 0 \\ 1 \\ 2 \end{pmatrix} \mid s \in \mathbb{R} \right\}$

(b)  $\left\{ \begin{pmatrix} 2 \\ 0 \\ 1 \end{pmatrix} + t \begin{pmatrix} 1 \\ 1 \\ -1 \end{pmatrix} \mid t \in \mathbb{R} \right\}, \left\{ s \begin{pmatrix} 0 \\ 1 \\ 2 \end{pmatrix} + w \begin{pmatrix} 0 \\ 4 \\ 1 \end{pmatrix} \mid s, w \in \mathbb{R} \right\}$

- 1.8 When a plane does not pass through the origin, performing operations on vectors whose bodies lie in it is more complicated than when the plane passes through the origin. Consider the picture in this subsection of the plane

$$\left\{ \begin{pmatrix} 2 \\ 0 \\ 0 \end{pmatrix} + \begin{pmatrix} -0.5 \\ 1 \\ 0 \end{pmatrix} y + \begin{pmatrix} -0.5 \\ 0 \\ 1 \end{pmatrix} z \mid y, z \in \mathbb{R} \right\}$$

and the three vectors with endpoints  $(2, 0, 0)$ ,  $(1.5, 1, 0)$ , and  $(1.5, 0, 1)$ .

- (a) Redraw the picture, including the vector in the plane that is twice as long as the one with endpoint  $(1.5, 1, 0)$ . The endpoint of your vector is not  $(3, 2, 0)$ ; what is it?
- (b) Redraw the picture, including the parallelogram in the plane that shows the sum of the vectors ending at  $(1.5, 0, 1)$  and  $(1.5, 1, 0)$ . The endpoint of the sum, on the diagonal, is not  $(3, 1, 1)$ ; what is it?
- 1.9 Show that the line segments  $\overline{(a_1, a_2)(b_1, b_2)}$  and  $\overline{(c_1, c_2)(d_1, d_2)}$  have the same lengths and slopes if  $b_1 - a_1 = d_1 - c_1$  and  $b_2 - a_2 = d_2 - c_2$ . Is that only if?
- 1.10 How should we define  $\mathbb{R}^0$ ?
- ? ✓ 1.11 [Math. Mag., Jan. 1957] A person traveling eastward at a rate of 3 miles per hour finds that the wind appears to blow directly from the north. On doubling his speed it appears to come from the north east. What was the wind's velocity?
- 1.12 Euclid describes a plane as "a surface which lies evenly with the straight lines on itself". Commentators such as Heron have interpreted this to mean, "(A plane surface is) such that, if a straight line pass through two points on it, the line coincides wholly with it at every spot, all ways". (Translations from [Heath], pp. 171-172.) Do planes, as described in this section, have that property? Does this description adequately define planes?

## II.2 Length and Angle Measures

We've translated the first section's results about solution sets into geometric terms, to better understand those sets. But we must be careful not to be misled by our own terms—labeling subsets of  $\mathbb{R}^k$  of the forms  $\{\vec{p} + t\vec{v} \mid t \in \mathbb{R}\}$  and  $\{\vec{p} + t\vec{v} + s\vec{w} \mid t, s \in \mathbb{R}\}$  as 'lines' and 'planes' doesn't make them act like the lines and planes of our past experience. Rather, we must ensure that the names suit the sets. While we can't prove that the sets satisfy our intuition—we can't prove anything about intuition—in this subsection we'll observe that a result familiar from  $\mathbb{R}^2$  and  $\mathbb{R}^3$ , when generalized to arbitrary  $\mathbb{R}^n$ , supports the idea that a line is straight and a plane is flat. Specifically, we'll see how to do Euclidean geometry in a "plane" by giving a definition of the angle between two  $\mathbb{R}^n$  vectors in the plane that they generate.

**2.1 Definition** The *length* (or *norm*) of a vector  $\vec{v} \in \mathbb{R}^n$  is this.

$$\|\vec{v}\| = \sqrt{v_1^2 + \cdots + v_n^2}$$

**2.2 Remark** This is a natural generalization of the Pythagorean Theorem. A classic discussion is in [Polya].

Note that for any nonzero  $\vec{v}$ , the vector  $\vec{v}/\|\vec{v}\|$  has length one. We say that the second vector *normalizes*  $\vec{v}$  to length one.

We can use that to get a formula for the angle between two vectors. Consider two vectors in  $\mathbb{R}^3$ .

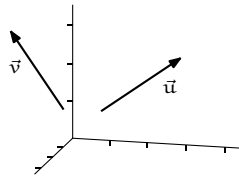

Put them in canonical position and, in the two-dimensional plane that they determine, consider the triangle formed by  $\vec{u}$ ,  $\vec{v}$ , and  $\vec{u} - \vec{v}$ .

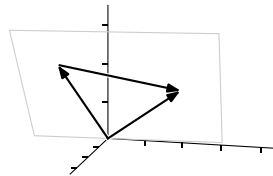

Apply the Law of Cosines,  $\|\vec{u} - \vec{v}\|^2 = \|\vec{u}\|^2 + \|\vec{v}\|^2 - 2\|\vec{u}\|\|\vec{v}\|\cos\theta$ , where  $\theta$  is the angle between the vectors. The left side gives

$$\begin{aligned} & (u_1 - v_1)^2 + (u_2 - v_2)^2 + (u_3 - v_3)^2 \\ &= (u_1^2 - 2u_1v_1 + v_1^2) + (u_2^2 - 2u_2v_2 + v_2^2) + (u_3^2 - 2u_3v_3 + v_3^2) \end{aligned}$$



while the right side gives this.

$$(u_1^2 + u_2^2 + u_3^2) + (v_1^2 + v_2^2 + v_3^2) - 2 \|\vec{u}\| \|\vec{v}\| \cos \theta$$

Canceling squares and dividing by 2 gives the formula that we want.

$$\theta = \arccos\left(\frac{u_1v_1 + u_2v_2 + u_3v_3}{\|\vec{u}\| \|\vec{v}\|}\right)$$

To give a definition of angle in higher dimensions we cannot draw pictures but we can make the argument analytically.

First, the form of the numerator is clear — it comes from the middle terms of  $(u_i - v_i)^2$ .

**2.3 Definition** The *dot product* (or *inner product*, or *scalar product*) of two  $n$ -component real vectors is the linear combination of their components.

$$\vec{u} \cdot \vec{v} = u_1v_1 + u_2v_2 + \cdots + u_nv_n$$

Note that the dot product of two vectors is a real number, not a vector, and that the dot product of a vector from  $\mathbb{R}^n$  with a vector from  $\mathbb{R}^m$  is not defined unless  $n$  equals  $m$ . Note also this relationship between dot product and length:  $\vec{u} \cdot \vec{u} = u_1u_1 + \cdots + u_nu_n = \|\vec{u}\|^2$ .

**2.4 Remark** Some authors require that the first vector be a row vector and that the second vector be a column vector. We shall not be that strict and will allow the dot product operation between two column vectors.

Still reasoning with letters but guided by the pictures, we use the next theorem to argue that the triangle formed by  $\vec{u}$ ,  $\vec{v}$ , and  $\vec{u} - \vec{v}$  in  $\mathbb{R}^n$  lies in the planar subset of  $\mathbb{R}^n$  generated by  $\vec{u}$  and  $\vec{v}$ .

**2.5 Theorem (Triangle Inequality)** For any  $\vec{u}, \vec{v} \in \mathbb{R}^n$ ,

$$\|\vec{u} + \vec{v}\| \leq \|\vec{u}\| + \|\vec{v}\|$$

with equality if and only if one of the vectors is a nonnegative scalar multiple of the other one.

This is the source of the familiar saying, “The shortest distance between two points is in a straight line.”

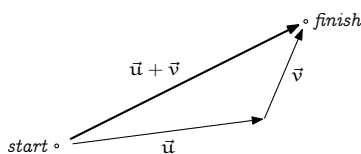

**PROOF** (We'll use some algebraic properties of dot product that we have not yet checked, for instance that  $\vec{u} \cdot (\vec{a} + \vec{b}) = \vec{u} \cdot \vec{a} + \vec{u} \cdot \vec{b}$  and that  $\vec{u} \cdot \vec{v} = \vec{v} \cdot \vec{u}$ . See

Exercise 17.) Since all the numbers are positive, the inequality holds if and only if its square holds.

$$\begin{aligned}\|\vec{u} + \vec{v}\|^2 &\leq (\|\vec{u}\| + \|\vec{v}\|)^2 \\ (\vec{u} + \vec{v}) \cdot (\vec{u} + \vec{v}) &\leq \|\vec{u}\|^2 + 2\|\vec{u}\|\|\vec{v}\| + \|\vec{v}\|^2 \\ \vec{u} \cdot \vec{u} + \vec{u} \cdot \vec{v} + \vec{v} \cdot \vec{u} + \vec{v} \cdot \vec{v} &\leq \vec{u} \cdot \vec{u} + 2\|\vec{u}\|\|\vec{v}\| + \vec{v} \cdot \vec{v} \\ 2\vec{u} \cdot \vec{v} &\leq 2\|\vec{u}\|\|\vec{v}\|\end{aligned}$$

That, in turn, holds if and only if the relationship obtained by multiplying both sides by the nonnegative numbers  $\|\vec{u}\|$  and  $\|\vec{v}\|$

$$2(\|\vec{v}\|\vec{u}) \cdot (\|\vec{u}\|\vec{v}) \leq 2\|\vec{u}\|^2\|\vec{v}\|^2$$

and rewriting

$$0 \leq \|\vec{u}\|^2\|\vec{v}\|^2 - 2(\|\vec{v}\|\vec{u}) \cdot (\|\vec{u}\|\vec{v}) + \|\vec{u}\|^2\|\vec{v}\|^2$$

is true. But factoring

$$0 \leq (\|\vec{u}\|\vec{v} - \|\vec{v}\|\vec{u}) \cdot (\|\vec{u}\|\vec{v} - \|\vec{v}\|\vec{u})$$

shows that this certainly is true since it only says that the square of the length of the vector  $\|\vec{u}\|\vec{v} - \|\vec{v}\|\vec{u}$  is not negative.

As for equality, it holds when, and only when,  $\|\vec{u}\|\vec{v} - \|\vec{v}\|\vec{u}$  is  $\vec{0}$ . The check that  $\|\vec{u}\|\vec{v} = \|\vec{v}\|\vec{u}$  if and only if one vector is a nonnegative real scalar multiple of the other is easy. QED

This result supports the intuition that even in higher-dimensional spaces, lines are straight and planes are flat. We can easily check from the definition that linear surfaces have the property that for any two points in that surface, the line segment between them is contained in that surface. But if the linear surface were not flat then that would allow for a shortcut.

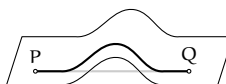

Because the Triangle Inequality says that in any  $\mathbb{R}^n$  the shortest cut between two endpoints is simply the line segment connecting them, linear surfaces have no bends.

Back to the definition of angle measure. The heart of the Triangle Inequality's proof is the  $\vec{u} \cdot \vec{v} \leq \|\vec{u}\|\|\vec{v}\|$  line. We might wonder if some pairs of vectors satisfy the inequality in this way: while  $\vec{u} \cdot \vec{v}$  is a large number, with absolute value bigger than the right-hand side, it is a negative large number. The next result says that does not happen.

**2.6 Corollary (Cauchy-Schwartz Inequality)** For any  $\vec{u}, \vec{v} \in \mathbb{R}^n$ ,

$$|\vec{u} \cdot \vec{v}| \leq \|\vec{u}\|\|\vec{v}\|$$

with equality if and only if one vector is a scalar multiple of the other.

PROOF The Triangle Inequality's proof shows that  $\vec{u} \cdot \vec{v} \leq \|\vec{u}\| \|\vec{v}\|$  so if  $\vec{u} \cdot \vec{v}$  is positive or zero then we are done. If  $\vec{u} \cdot \vec{v}$  is negative then this holds.

$$|\vec{u} \cdot \vec{v}| = -(\vec{u} \cdot \vec{v}) = (-\vec{u}) \cdot \vec{v} \leq \|-\vec{u}\| \|\vec{v}\| = \|\vec{u}\| \|\vec{v}\|$$

The equality condition is Exercise 18.

QED

The Cauchy-Schwartz inequality assures us that the next definition makes sense because the fraction has absolute value less than or equal to one.

**2.7 Definition** The *angle* between two nonzero vectors  $\vec{u}, \vec{v} \in \mathbb{R}^n$  is

$$\theta = \arccos\left(\frac{\vec{u} \cdot \vec{v}}{\|\vec{u}\| \|\vec{v}\|}\right)$$

(by definition, the angle between the zero vector and any other vector is right).

Thus vectors from  $\mathbb{R}^n$  are orthogonal, that is, perpendicular, if and only if their dot product is zero.

**2.8 Example** These vectors are orthogonal.

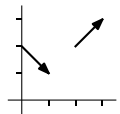

$$\begin{pmatrix} 1 \\ -1 \end{pmatrix} \cdot \begin{pmatrix} 1 \\ 1 \end{pmatrix} = 0$$

We've drawn the arrows away from canonical position but nevertheless the vectors are orthogonal.

**2.9 Example** The  $\mathbb{R}^3$  angle formula given at the start of this subsection is a special case of the definition. Between these two

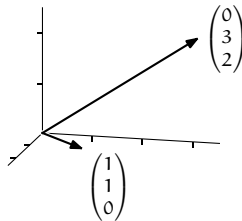

the angle is

$$\arccos\left(\frac{(1)(0) + (1)(3) + (0)(2)}{\sqrt{1^2 + 1^2 + 0^2} \sqrt{0^2 + 3^2 + 2^2}}\right) = \arccos\left(\frac{3}{\sqrt{2}\sqrt{13}}\right)$$

approximately 0.94 radians. Notice that these vectors are not orthogonal. Although the  $yz$ -plane may appear to be perpendicular to the  $xy$ -plane, in fact the two planes are that way only in the weak sense that there are vectors in each orthogonal to all vectors in the other. Not every vector in each is orthogonal to all vectors in the other.

### Exercises

✓ **2.10** Find the length of each vector.

$$(a) \begin{pmatrix} 3 \\ 1 \end{pmatrix} \quad (b) \begin{pmatrix} -1 \\ 2 \end{pmatrix} \quad (c) \begin{pmatrix} 4 \\ 1 \\ 1 \end{pmatrix} \quad (d) \begin{pmatrix} 0 \\ 0 \\ 0 \end{pmatrix} \quad (e) \begin{pmatrix} 1 \\ -1 \\ 1 \\ 0 \end{pmatrix}$$

- ✓ 2.11 Find the angle between each two, if it is defined.

$$(a) \begin{pmatrix} 1 \\ 2 \end{pmatrix}, \begin{pmatrix} 1 \\ 4 \end{pmatrix} \quad (b) \begin{pmatrix} 1 \\ 2 \\ 0 \end{pmatrix}, \begin{pmatrix} 0 \\ 4 \\ 1 \end{pmatrix} \quad (c) \begin{pmatrix} 1 \\ 2 \end{pmatrix}, \begin{pmatrix} 1 \\ 4 \\ -1 \end{pmatrix}$$

- ✓ 2.12 [Ohanian] During maneuvers preceding the Battle of Jutland, the British battle cruiser *Lion* moved as follows (in nautical miles): 1.2 miles north, 6.1 miles 38 degrees east of south, 4.0 miles at 89 degrees east of north, and 6.5 miles at 31 degrees east of north. Find the distance between starting and ending positions. (Ignore the earth's curvature.)

- 2.13 Find  $k$  so that these two vectors are perpendicular.

$$\begin{pmatrix} k \\ 1 \end{pmatrix} \quad \begin{pmatrix} 4 \\ 3 \end{pmatrix}$$

- 2.14 Describe the set of vectors in  $\mathbb{R}^3$  orthogonal to this one.

$$\begin{pmatrix} 1 \\ 3 \\ -1 \end{pmatrix}$$

- ✓ 2.15 (a) Find the angle between the diagonal of the unit square in  $\mathbb{R}^2$  and one of the axes.  
 (b) Find the angle between the diagonal of the unit cube in  $\mathbb{R}^3$  and one of the axes.  
 (c) Find the angle between the diagonal of the unit cube in  $\mathbb{R}^n$  and one of the axes.  
 (d) What is the limit, as  $n$  goes to  $\infty$ , of the angle between the diagonal of the unit cube in  $\mathbb{R}^n$  and one of the axes?

- 2.16 Is any vector perpendicular to itself?

- ✓ 2.17 Describe the algebraic properties of dot product.

- (a) Is it right-distributive over addition:  $(\vec{u} + \vec{v}) \cdot \vec{w} = \vec{u} \cdot \vec{w} + \vec{v} \cdot \vec{w}$ ?  
 (b) Is it left-distributive (over addition)?  
 (c) Does it commute?  
 (d) Associate?  
 (e) How does it interact with scalar multiplication?

As always, you must back any assertion with either a proof or an example.

- 2.18 Verify the equality condition in Corollary 2.6, the Cauchy-Schwartz Inequality.

- (a) Show that if  $\vec{u}$  is a negative scalar multiple of  $\vec{v}$  then  $\vec{u} \cdot \vec{v}$  and  $\vec{v} \cdot \vec{u}$  are less than or equal to zero.  
 (b) Show that  $|\vec{u} \cdot \vec{v}| = \|\vec{u}\| \|\vec{v}\|$  if and only if one vector is a scalar multiple of the other.

- 2.19 Suppose that  $\vec{u} \cdot \vec{v} = \vec{u} \cdot \vec{w}$  and  $\vec{u} \neq \vec{0}$ . Must  $\vec{v} = \vec{w}$ ?

- ✓ 2.20 Does any vector have length zero except a zero vector? (If “yes”, produce an example. If “no”, prove it.)

- ✓ 2.21 Find the midpoint of the line segment connecting  $(x_1, y_1)$  with  $(x_2, y_2)$  in  $\mathbb{R}^2$ . Generalize to  $\mathbb{R}^n$ .

- 2.22 Show that if  $\vec{v} \neq \vec{0}$  then  $\vec{v}/\|\vec{v}\|$  has length one. What if  $\vec{v} = \vec{0}$ ?

- 2.23 Show that if  $r \geq 0$  then  $r\vec{v}$  is  $r$  times as long as  $\vec{v}$ . What if  $r < 0$ ?
- ✓ 2.24 A vector  $\vec{v} \in \mathbb{R}^n$  of length one is a *unit* vector. Show that the dot product of two unit vectors has absolute value less than or equal to one. Can ‘less than’ happen? Can ‘equal to’?
- 2.25 Prove that  $\|\vec{u} + \vec{v}\|^2 + \|\vec{u} - \vec{v}\|^2 = 2\|\vec{u}\|^2 + 2\|\vec{v}\|^2$ .
- 2.26 Show that if  $\vec{x} \cdot \vec{y} = 0$  for every  $\vec{y}$  then  $\vec{x} = \vec{0}$ .
- 2.27 Is  $\|\vec{u}_1 + \cdots + \vec{u}_n\| \leq \|\vec{u}_1\| + \cdots + \|\vec{u}_n\|$ ? If it is true then it would generalize the Triangle Inequality.
- 2.28 What is the ratio between the sides in the Cauchy-Schwartz inequality?
- 2.29 Why is the zero vector defined to be perpendicular to every vector?
- 2.30 Describe the angle between two vectors in  $\mathbb{R}^1$ .
- 2.31 Give a simple necessary and sufficient condition to determine whether the angle between two vectors is acute, right, or obtuse.
- ✓ 2.32 Generalize to  $\mathbb{R}^n$  the converse of the Pythagorean Theorem, that if  $\vec{u}$  and  $\vec{v}$  are perpendicular then  $\|\vec{u} + \vec{v}\|^2 = \|\vec{u}\|^2 + \|\vec{v}\|^2$ .
- 2.33 Show that  $\|\vec{u}\| = \|\vec{v}\|$  if and only if  $\vec{u} + \vec{v}$  and  $\vec{u} - \vec{v}$  are perpendicular. Give an example in  $\mathbb{R}^2$ .
- 2.34 Show that if a vector is perpendicular to each of two others then it is perpendicular to each vector in the plane they generate. (*Remark.* They could generate a degenerate plane — a line or a point — but the statement remains true.)
- 2.35 Prove that, where  $\vec{u}, \vec{v} \in \mathbb{R}^n$  are nonzero vectors, the vector

$$\frac{\vec{u}}{\|\vec{u}\|} + \frac{\vec{v}}{\|\vec{v}\|}$$

bisects the angle between them. Illustrate in  $\mathbb{R}^2$ .

- 2.36 Verify that the definition of angle is dimensionally correct: (1) if  $k > 0$  then the cosine of the angle between  $k\vec{u}$  and  $\vec{v}$  equals the cosine of the angle between  $\vec{u}$  and  $\vec{v}$ , and (2) if  $k < 0$  then the cosine of the angle between  $k\vec{u}$  and  $\vec{v}$  is the negative of the cosine of the angle between  $\vec{u}$  and  $\vec{v}$ .
- ✓ 2.37 Show that the inner product operation is *linear*: for  $\vec{u}, \vec{v}, \vec{w} \in \mathbb{R}^n$  and  $k, m \in \mathbb{R}$ ,  $\vec{u} \cdot (k\vec{v} + m\vec{w}) = k(\vec{u} \cdot \vec{v}) + m(\vec{u} \cdot \vec{w})$ .
- ✓ 2.38 The *geometric mean* of two positive reals  $x, y$  is  $\sqrt{xy}$ . It is analogous to the *arithmetic mean*  $(x + y)/2$ . Use the Cauchy-Schwartz inequality to show that the geometric mean of any  $x, y \in \mathbb{R}$  is less than or equal to the arithmetic mean.
- ? 2.39 [Cleary] Astrologers claim to be able to recognize trends in personality and fortune that depend on an individual’s birthday by somehow incorporating where the stars were 2000 years ago, during the Hellenistic period. Suppose that instead of star-gazers coming up with stuff, math teachers who like linear algebra (we’ll call them vectologers) had come up with a similar system as follows: Consider your birthday as a row vector (month day). For instance, I was born on July 12 so my vector would be  $(7 \ 12)$ . Vectologers have made the rule that how well individuals get along with each other depends on the angle between vectors. The smaller the angle, the more harmonious the relationship.
- Compute the angle between your vector and mine, expressing the answer in radians.
  - Would you get along better with me, or with a professor born on September 19?
  - For maximum harmony in a relationship, when should the other person be born?

(d) Is there a person with whom you have a “worst case” relationship, i.e., your vector and theirs are orthogonal? If so, what are the birthdate(s) for such people? If not, explain why not.

? 2.40 [Am. Math. Mon., Feb. 1933] A ship is sailing with speed and direction  $\vec{v}_1$ ; the wind blows apparently (judging by the vane on the mast) in the direction of a vector  $\vec{a}$ ; on changing the direction and speed of the ship from  $\vec{v}_1$  to  $\vec{v}_2$  the apparent wind is in the direction of a vector  $\vec{b}$ .

Find the vector velocity of the wind.

2.41 Verify the Cauchy-Schwartz inequality by first proving Lagrange’s identity:

$$\left( \sum_{1 \leq j \leq n} a_j b_j \right)^2 = \left( \sum_{1 \leq j \leq n} a_j^2 \right) \left( \sum_{1 \leq j \leq n} b_j^2 \right) - \sum_{1 \leq k < j \leq n} (a_k b_j - a_j b_k)^2$$

and then noting that the final term is positive. (Recall the meaning

$$\sum_{1 \leq j \leq n} a_j b_j = a_1 b_1 + a_2 b_2 + \cdots + a_n b_n$$

and

$$\sum_{1 \leq j \leq n} a_j^2 = a_1^2 + a_2^2 + \cdots + a_n^2$$

of the  $\Sigma$  notation.) This result is an improvement over Cauchy-Schwartz because it gives a formula for the difference between the two sides. Interpret that difference in  $\mathbb{R}^2$ .

### III Reduced Echelon Form

After developing the mechanics of Gauss' method, we observed that it can be done in more than one way. For example, from this matrix

$$\begin{pmatrix} 2 & 2 \\ 4 & 3 \end{pmatrix}$$

we could derive any of these three echelon form matrices.

$$\begin{pmatrix} 2 & 2 \\ 0 & -1 \end{pmatrix} \quad \begin{pmatrix} 1 & 1 \\ 0 & -1 \end{pmatrix} \quad \begin{pmatrix} 2 & 0 \\ 0 & -1 \end{pmatrix}$$

The first results from  $-2\rho_1 + \rho_2$ . The second comes from following  $(1/2)\rho_1$  with  $-4\rho_1 + \rho_2$ . The third comes from  $-2\rho_1 + \rho_2$  followed by  $2\rho_2 + \rho_1$  (after the first row combination the matrix is already in echelon form so the second one is extra work but it is nonetheless a legal row operation).

The fact that echelon form is not unique raises questions. Will any two echelon form versions of a linear system have the same number of free variables? If yes, will the two have exactly the same free variables? In this section we will give a way to decide if one linear system can be derived from another by row operations. The answers to both questions, both "yes," will follow from this.

#### III.1 Gauss-Jordan Reduction

Gaussian elimination coupled with back-substitution solves linear systems but it is not the only method possible. Here is an extension of Gauss' method that has some advantages.

**1.1 Example** To solve

$$\begin{aligned} x + y - 2z &= -2 \\ y + 3z &= 7 \\ x - z &= -1 \end{aligned}$$

we can start as usual by going to echelon form.

$$\xrightarrow{-\rho_1 + \rho_3} \left( \begin{array}{ccc|c} 1 & 1 & -2 & -2 \\ 0 & 1 & 3 & 7 \\ 0 & -1 & 1 & 1 \end{array} \right) \xrightarrow{\rho_2 + \rho_3} \left( \begin{array}{ccc|c} 1 & 1 & -2 & -2 \\ 0 & 1 & 3 & 7 \\ 0 & 0 & 4 & 8 \end{array} \right)$$

We can keep going to a second stage by making the leading entries into 1's

$$\xrightarrow{(1/4)\rho_3} \left( \begin{array}{ccc|c} 1 & 1 & -2 & -2 \\ 0 & 1 & 3 & 7 \\ 0 & 0 & 1 & 2 \end{array} \right)$$

and then to a third stage that uses the leading entries to eliminate all of the other entries in each column by combining upwards.

$$\begin{array}{c} -3\rho_3 + \rho_2 \\ 2\rho_3 + \rho_1 \end{array} \left( \begin{array}{ccc|c} 1 & 1 & 0 & 2 \\ 0 & 1 & 0 & 1 \\ 0 & 0 & 1 & 2 \end{array} \right) \xrightarrow{-\rho_2 + \rho_1} \left( \begin{array}{ccc|c} 1 & 0 & 0 & 1 \\ 0 & 1 & 0 & 1 \\ 0 & 0 & 1 & 2 \end{array} \right)$$

The answer is  $x = 1$ ,  $y = 1$ , and  $z = 2$ .

Using one entry to clear out the rest of a column is *pivoting* on that entry.

Note that the row combination operations in the first stage move left to right, from column one to column three, while the combination operations in the third stage move right to left.

**1.2 Example** The middle stage operations that turn the leading entries into 1's don't interact, so we can combine multiple ones into a single step.

$$\begin{array}{c} -2\rho_1 + \rho_2 \\ (1/2)\rho_1 \\ (-1/4)\rho_2 \\ -(1/2)\rho_2 + \rho_1 \end{array} \left( \begin{array}{cc|c} 2 & 1 & 7 \\ 4 & -2 & 6 \end{array} \right) \xrightarrow{\quad} \left( \begin{array}{cc|c} 2 & 1 & 7 \\ 0 & -4 & -8 \end{array} \right) \xrightarrow{\quad} \left( \begin{array}{cc|c} 1 & 1/2 & 7/2 \\ 0 & 1 & 2 \end{array} \right) \xrightarrow{\quad} \left( \begin{array}{cc|c} 1 & 0 & 5/2 \\ 0 & 1 & 2 \end{array} \right)$$

The answer is  $x = 5/2$  and  $y = 2$ .

This extension of Gauss' method is *Gauss-Jordan reduction*.

**1.3 Definition** A matrix or linear system is in *reduced echelon form* if, in addition to being in echelon form, each leading entry is a one and is the only nonzero entry in its column.

The cost of using Gauss-Jordan reduction to solve a system is the additional arithmetic. The benefit is that we can just read off the solution set from the reduced echelon form.

In any echelon form, reduced or not, we can read off when the system has an empty solution set because there is a contradictory equation. We can read off when the system has a one-element solution set because there is no contradiction and every variable is the leading variable in some row. And, we can read off when the system has an infinite solution set because there is no contradiction and at least one variable is free.

In reduced echelon form we can read off not just the size of the solution set but also its description. We have no trouble describing the solution set when it is empty, of course. Example 1.1 and 1.2 show how in a single element solution set case the single element is in the column of constants. The next example shows how to read the parametrization of an infinite solution set from reduced echelon form.



## 1.4 Example

$$\begin{aligned} \left( \begin{array}{cccc|c} 2 & 6 & 1 & 2 & 5 \\ 0 & 3 & 1 & 4 & 1 \\ 0 & 3 & 1 & 2 & 5 \end{array} \right) &\xrightarrow{-\rho_2 + \rho_3} \left( \begin{array}{cccc|c} 2 & 6 & 1 & 2 & 5 \\ 0 & 3 & 1 & 4 & 1 \\ 0 & 0 & 0 & -2 & 4 \end{array} \right) \\ &\xrightarrow{\substack{(1/2)\rho_1 \\ (1/3)\rho_2 \\ -(1/2)\rho_3}} \xrightarrow{\substack{(4/3)\rho_3 + \rho_2 \\ -\rho_3 + \rho_1}} \xrightarrow{-3\rho_2 + \rho_1} \left( \begin{array}{cccc|c} 1 & 0 & -1/2 & 0 & -9/2 \\ 0 & 1 & 1/3 & 0 & 3 \\ 0 & 0 & 0 & 1 & -2 \end{array} \right) \end{aligned}$$

As a linear system this is

$$\begin{aligned} x_1 - 1/2x_3 &= -9/2 \\ x_2 + 1/3x_3 &= 3 \\ x_4 &= -2 \end{aligned}$$

so a solution set description is this.

$$S = \left\{ \begin{pmatrix} x_1 \\ x_2 \\ x_3 \\ x_4 \end{pmatrix} = \begin{pmatrix} -9/2 \\ 3 \\ 0 \\ -2 \end{pmatrix} + \begin{pmatrix} 1/2 \\ -1/3 \\ 1 \\ 0 \end{pmatrix} x_3 \mid x_3 \in \mathbb{R} \right\}$$

Thus echelon form isn't some kind of one best form for systems. Other forms, such as reduced echelon form, have advantages and disadvantages. Instead of picturing linear systems (and the associated matrices) as things we operate on, always directed toward the goal of echelon form, we can think of them as interrelated when we can get from one to another by row operations. The rest of this subsection develops this relationship.

**1.5 Lemma** Elementary row operations are reversible.

**PROOF** For any matrix  $A$ , the effect of swapping rows is reversed by swapping them back, multiplying a row by a nonzero  $k$  is undone by multiplying by  $1/k$ , and adding a multiple of row  $i$  to row  $j$  (with  $i \neq j$ ) is undone by subtracting the same multiple of row  $i$  from row  $j$ .

$$A \xrightarrow{\rho_i \leftrightarrow \rho_j} A \xrightarrow{\rho_j \leftrightarrow \rho_i} A \quad A \xrightarrow{k\rho_i} A \xrightarrow{(1/k)\rho_i} A \quad A \xrightarrow{k\rho_i + \rho_j} A \xrightarrow{-k\rho_i + \rho_j} A$$

(We need the  $i \neq j$  condition; see Exercise 16.)

QED

Again, the point of view that we are developing, buttressed now by this lemma, is that the term 'reduces to' is misleading: where  $A \rightarrow B$ , we shouldn't think of  $B$  as "after"  $A$  or "simpler than"  $A$ . Instead we should think of them as inter-reducible or interrelated. Below is a picture of the idea. It shows the matrices from the start of this section and their reduced echelon form version in a cluster as inter-reducible.

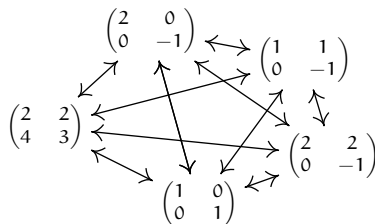

We say that matrices that reduce to each other are ‘equivalent with respect to the relationship of row reducibility’. The next result verifies this statement using the definition of an equivalence.\*

**1.6 Lemma** Between matrices, ‘reduces to’ is an equivalence relation.

**PROOF** We must check the conditions (i) reflexivity, that any matrix reduces to itself, (ii) symmetry, that if  $A$  reduces to  $B$  then  $B$  reduces to  $A$ , and (iii) transitivity, that if  $A$  reduces to  $B$  and  $B$  reduces to  $C$  then  $A$  reduces to  $C$ .

Reflexivity is easy; any matrix reduces to itself in zero row operations.

That the relationship is symmetric is Lemma 1.5—if  $A$  reduces to  $B$  by some row operations then also  $B$  reduces to  $A$  by reversing those operations.

For transitivity, suppose that  $A$  reduces to  $B$  and that  $B$  reduces to  $C$ . Following the reduction steps from  $A \rightarrow \cdots \rightarrow B$  with those from  $B \rightarrow \cdots \rightarrow C$  gives a reduction from  $A$  to  $C$ . QED

**1.7 Definition** Two matrices that are inter-reducible by the elementary row operations are *row equivalent*.

The diagram below shows the collection of all matrices as a box. Inside that box, each matrix lies in some class. Matrices are in the same class if and only if they are interreducible. The classes are disjoint—no matrix is in two distinct classes. We have partitioned the collection of matrices into *row equivalence classes*.<sup>†</sup>

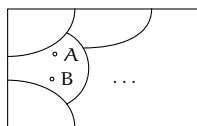

One of the classes in this partition is the cluster of matrices from the start of this section shown above, expanded to include all of the nonsingular  $2 \times 2$  matrices.

The next subsection proves that the reduced echelon form of a matrix is unique. Rephrased in terms of the row-equivalence relationship, we shall prove that every matrix is row equivalent to one and only one reduced echelon form matrix. In terms of the partition what we shall prove is: every equivalence class contains one and only one reduced echelon form matrix. So each reduced echelon form matrix serves as a representative of its class.

\* More information on equivalence relations is in the appendix.

† More information on partitions and class representatives is in the appendix.

## Exercises

✓ 1.8 Use Gauss-Jordan reduction to solve each system.

$$(a) \begin{cases} x + y = 2 \\ x - y = 0 \end{cases} \quad (b) \begin{cases} x - z = 4 \\ 2x + 2y = 1 \end{cases} \quad (c) \begin{cases} 3x - 2y = 1 \\ 6x + y = 1/2 \end{cases}$$

$$(d) \begin{cases} 2x - y = -1 \\ x + 3y - z = 5 \\ y + 2z = 5 \end{cases}$$

✓ 1.9 Find the reduced echelon form of each matrix.

$$(a) \begin{pmatrix} 2 & 1 \\ 1 & 3 \end{pmatrix} \quad (b) \begin{pmatrix} 1 & 3 & 1 \\ 2 & 0 & 4 \\ -1 & -3 & -3 \end{pmatrix} \quad (c) \begin{pmatrix} 1 & 0 & 3 & 1 & 2 \\ 1 & 4 & 2 & 1 & 5 \\ 3 & 4 & 8 & 1 & 2 \end{pmatrix}$$

$$(d) \begin{pmatrix} 0 & 1 & 3 & 2 \\ 0 & 0 & 5 & 6 \\ 1 & 5 & 1 & 5 \end{pmatrix}$$

✓ 1.10 Find each solution set by using Gauss-Jordan reduction and then reading off the parametrization.

$$(a) \begin{cases} 2x + y - z = 1 \\ 4x - y = 3 \end{cases} \quad (b) \begin{cases} x - z = 1 \\ y + 2z - w = 3 \\ x + 2y + 3z - w = 7 \end{cases} \quad (c) \begin{cases} x - y + z = 0 \\ y + w = 0 \\ 3x - 2y + 3z + w = 0 \\ -y - w = 0 \end{cases}$$

$$(d) \begin{cases} a + 2b + 3c + d - e = 1 \\ 3a - b + c + d + e = 3 \end{cases}$$

1.11 Give two distinct echelon form versions of this matrix.

$$\begin{pmatrix} 2 & 1 & 1 & 3 \\ 6 & 4 & 1 & 2 \\ 1 & 5 & 1 & 5 \end{pmatrix}$$

✓ 1.12 List the reduced echelon forms possible for each size.

$$(a) 2 \times 2 \quad (b) 2 \times 3 \quad (c) 3 \times 2 \quad (d) 3 \times 3$$

✓ 1.13 What results from applying Gauss-Jordan reduction to a nonsingular matrix?

1.14 [Cleary] Consider the following relationship on the set of  $2 \times 2$  matrices: we say that  $A$  is *sum-what like*  $B$  if the sum of all of the entries in  $A$  is the same as the sum of all the entries in  $B$ . For instance, the zero matrix would be sum-what like the matrix whose first row had two sevens, and whose second row had two negative sevens. Prove or disprove that this is an equivalence relation on the set of  $2 \times 2$  matrices.

1.15 [Cleary] Consider the set of students in a class. Which of the following relationships are equivalence relations? Explain each answer in at least a sentence.

- (a) Two students  $x$  and  $y$  are related if  $x$  has taken at least as many math classes as  $y$ .  
 (b) Students  $x$  and  $y$  are related if  $x$  and  $y$  have names that start with the same letter.

1.16 The proof of Lemma 1.5 contains a reference to the  $i \neq j$  condition on the row combination operation.

- (a) The definition of row operations has an  $i \neq j$  condition on the swap operation  $\rho_i \leftrightarrow \rho_j$ . Show that in  $A \xrightarrow{\rho_i \leftrightarrow \rho_j} \rho_i \leftrightarrow \rho_j A$  this condition is not needed.  
 (b) Write down a  $2 \times 2$  matrix with nonzero entries, and show that the  $-1 \cdot \rho_1 + \rho_1$  operation is not reversed by  $1 \cdot \rho_1 + \rho_1$ .

- (c) Expand the proof of that lemma to make explicit exactly where it uses the  $i \neq j$  condition on combining.

## III.2 The Linear Combination Lemma

We will close this section and this chapter by proving that every matrix is row equivalent to one and only one reduced echelon form matrix. The ideas that appear here will reappear, and be further developed, in the next chapter.

The underlying theme here is that one way to understand a mathematical situation is by being able to classify the cases that can happen. We have met this theme several times already. We have classified solution sets of linear systems into the no-elements, one-element, and infinitely-many elements cases. We have also classified linear systems with the same number of equations as unknowns into the nonsingular and singular cases. We adopted these classifications because they give us a way to understand the situations that we were investigating. Here, where we are investigating row equivalence, we know that the set of all matrices breaks into the row equivalence classes. When we finish the proof here, we will have a way to understand each of those classes—we can think of its matrices as derived by row operations from the unique reduced echelon form matrix in that class.

Put in more operational terms, after that proof we will (as promised in this section's opening) have a way to decide if one matrix can be derived from another by row reduction. We apply the Gauss-Jordan procedure to both and see whether or not they come to the same reduced echelon form.

To understand how row operations act to transform one matrix into another, we consider the effect that they have on the parts of a matrix. The crucial observation is that row operations combine the rows linearly.

**2.1 Lemma (Linear Combination Lemma)** A linear combination of linear combinations is a linear combination.

**PROOF** Given the linear combinations  $c_{1,1}x_1 + \cdots + c_{1,n}x_n$  through  $c_{m,1}x_1 + \cdots + c_{m,n}x_n$ , consider a combination of those

$$d_1(c_{1,1}x_1 + \cdots + c_{1,n}x_n) + \cdots + d_m(c_{m,1}x_1 + \cdots + c_{m,n}x_n)$$

where the  $d$ 's are scalars along with the  $c$ 's. Distributing those  $d$ 's and regrouping gives

$$= (d_1c_{1,1} + \cdots + d_m c_{m,1})x_1 + \cdots + (d_1c_{1,n} + \cdots + d_m c_{m,n})x_n$$

which is a linear combination of the  $x$ 's.

QED

In this subsection we will use the convention that, where an upper case roman letter names the matrix then the matching lower-case greek letter names

the rows.

$$A = \begin{pmatrix} \cdots & \vec{\alpha}_1 & \cdots \\ \cdots & \vec{\alpha}_2 & \cdots \\ & \vdots & \\ \cdots & \vec{\alpha}_m & \cdots \end{pmatrix} \quad B = \begin{pmatrix} \cdots & \vec{\beta}_1 & \cdots \\ \cdots & \vec{\beta}_2 & \cdots \\ & \vdots & \\ \cdots & \vec{\beta}_m & \cdots \end{pmatrix}$$

**2.2 Corollary** Where one matrix reduces to another, each row of the second is a linear combination of the rows of the first.

The proof uses induction.\* Before we proceed, here is an outline of the argument. For the base step, we will verify that the proposition is true when reduction can be done in zero row operations. For the inductive step, we will argue that if being able to reduce the first matrix to the second in some number  $t \geq 0$  of operations implies that each row of the second is a linear combination of the rows of the first, then being able to reduce the first to the second in  $t + 1$  operations implies the same thing. Together these prove the result because the base step shows that it is true in the zero operations case, and then the inductive step implies that it is true in the one operation case, and then the inductive step applied again gives that it is therefore true for two operations, etc.

**PROOF** We proceed by induction on the minimum number of row operations that take a first matrix  $A$  to a second one  $B$ . In the base step, that zero reduction operations suffice, the two matrices are equal and each row of  $B$  is trivially a combination of  $A$ 's rows:  $\vec{\beta}_i = 0 \cdot \vec{\alpha}_1 + \cdots + 1 \cdot \vec{\alpha}_i + \cdots + 0 \cdot \vec{\alpha}_m$ .

For the inductive step, assume the inductive hypothesis: with  $t \geq 0$ , any matrix that can be derived from  $A$  in  $t$  or fewer operations then has rows that are linear combinations of  $A$ 's rows. Suppose that reducing from  $A$  to  $B$  requires  $t + 1$  operations. There must be a next-to-last matrix  $G$  so that  $A \rightarrow \cdots \rightarrow G \rightarrow B$ . The inductive hypothesis applies to this  $G$  because it is only  $t$  operations away from  $A$ . That is, each row of  $G$  is a linear combination of the rows of  $A$ .

Now, if the operation taking  $G$  to  $B$  is a row swap then the rows of  $B$  are just the rows of  $G$  reordered, and thus each row of  $B$  is a linear combination of the rows of  $G$ . If the operation taking  $G$  to  $B$  is multiplication of some row  $i$  by a scalar  $c$  then the rows of  $B$  are a linear combination of the rows of  $G$ ; in particular,  $\vec{\beta}_i = c\vec{\gamma}_i$ . And if the operation is adding a multiple of one row to another then clearly the rows of  $B$  are linear combinations of the rows of  $G$ . In all three cases the Linear Combination Lemma applies to show that each row of  $B$  is a linear combination of the rows of  $A$ .

With both a base step and an inductive step, the proposition follows by the principle of mathematical induction. QED

---

\* More information on mathematical induction is in the appendix.

**2.3 Example** In the reduction

$$\begin{pmatrix} 0 & 2 \\ 1 & 1 \end{pmatrix} \xrightarrow{\rho_1 \leftrightarrow \rho_2} \begin{pmatrix} 1 & 1 \\ 0 & 2 \end{pmatrix} \xrightarrow{(1/2)\rho_2} \begin{pmatrix} 1 & 1 \\ 0 & 1 \end{pmatrix} \xrightarrow{-\rho_2 + \rho_1} \begin{pmatrix} 1 & 0 \\ 0 & 1 \end{pmatrix}$$

call the matrices A, D, G, and B. The methods of the proof show that there are three sets of linear relationships.

$$\begin{aligned} \vec{\delta}_1 &= 0 \cdot \vec{\alpha}_1 + 1 \cdot \vec{\alpha}_2 & \vec{\gamma}_1 &= 0 \cdot \vec{\alpha}_1 + 1 \cdot \vec{\alpha}_2 & \vec{\beta}_1 &= (-1/2)\vec{\alpha}_1 + 1 \cdot \vec{\alpha}_2 \\ \vec{\delta}_2 &= 1 \cdot \vec{\alpha}_1 + 0 \cdot \vec{\alpha}_2 & \vec{\gamma}_2 &= (1/2)\vec{\alpha}_1 + 0 \cdot \vec{\alpha}_2 & \vec{\beta}_2 &= (1/2)\vec{\alpha}_1 + 0 \cdot \vec{\alpha}_2 \end{aligned}$$

The prior result gives us the insight that Gauss' method works by taking linear combinations of the rows. But to what end; why do we go to echelon form as a particularly simple, or basic, version of a linear system? The answer, of course, is that echelon form is suitable for back substitution, because we have isolated the variables. For instance, in this matrix

$$R = \begin{pmatrix} 2 & 3 & 7 & 8 & 0 & 0 \\ 0 & 0 & 1 & 5 & 1 & 1 \\ 0 & 0 & 0 & 3 & 3 & 0 \\ 0 & 0 & 0 & 0 & 2 & 1 \end{pmatrix}$$

$x_1$  has been removed from  $x_5$ 's equation. That is, Gauss' method has made  $x_5$ 's row independent of  $x_1$ 's row.

The following result makes this precise. What Gauss' linear elimination method eliminates is linear relationships among the rows.

**2.4 Lemma** In an echelon form matrix, no nonzero row is a linear combination of the other nonzero rows.

**PROOF** Let R be in echelon form and consider the non- $\vec{0}$  rows. First observe that if we have a row written as a combination of the others  $\vec{\rho}_i = c_1\vec{\rho}_1 + \cdots + c_{i-1}\vec{\rho}_{i-1} + c_{i+1}\vec{\rho}_{i+1} + \cdots + c_m\vec{\rho}_m$  then we can rewrite that equation as

$$\vec{0} = c_1\vec{\rho}_1 + \cdots + c_{i-1}\vec{\rho}_{i-1} + c_i\vec{\rho}_i + c_{i+1}\vec{\rho}_{i+1} + \cdots + c_m\vec{\rho}_m \quad (*)$$

where not all the coefficients are zero; specifically,  $c_i = -1$ . The converse holds also: given equation (\*) where some  $c_i \neq 0$  then we could express  $\vec{\rho}_i$  as a combination of the other rows by moving  $c_i\vec{\rho}_i$  to the left side and dividing by  $c_i$ . Therefore we will have proved the theorem if we show that in (\*) all of the coefficients are 0. For that we use induction on the row index  $i$ .

The base case is the first row  $i = 1$  (if there is no such nonzero row, so R is the zero matrix, then the lemma holds vacuously). Recall our notation that  $\ell_i$  is the column number of the leading entry in row  $i$ . Equation (\*) applied to the entries of those rows from column  $\ell_1$  gives this.

$$0 = c_1r_{1,\ell_1} + c_2r_{2,\ell_1} + \cdots + c_m r_{m,\ell_1}$$

The matrix is in echelon form so every row after the first has a zero in that column  $r_{2,\ell_1} = \cdots = r_{m,\ell_1} = 0$ . Thus  $c_1 = 0$  because  $r_{1,\ell_1} \neq 0$ , as it leads the row.

The inductive step is to prove the implication: if for each row index  $k \in \{1, \dots, i\}$  the coefficient  $c_k$  is 0 then  $c_{i+1}$  is also 0. Consider the entries from column  $\ell_{i+1}$  in equation (\*).

$$0 = c_1 r_{1,\ell_{i+1}} + \cdots + c_{i+1} r_{i+1,\ell_{i+1}} + \cdots + c_m r_{m,\ell_{i+1}}$$

By the inductive hypothesis the coefficients  $c_1, \dots, c_i$  are all 0 so the equation reduces to  $0 = c_{i+1} r_{i+1,\ell_{i+1}} + \cdots + c_m r_{m,\ell_{i+1}}$ . The matrix is in echelon form so  $r_{i+2,\ell_{i+1}} = \cdots = r_{m,\ell_{i+1}} = 0$  and  $r_{i+1,\ell_{i+1}} \neq 0$ . Thus  $c_{i+1} = 0$ . QED

**2.5 Theorem** Each matrix is row equivalent to a unique reduced echelon form matrix.

**PROOF** [Yuster] Fix a number of rows  $m$ . We will proceed by induction on the number of columns  $n$ .

The base case is that the matrix has  $n = 1$  column. If this is the zero matrix then its unique echelon form is the zero matrix. If instead it has any nonzero entries then when the matrix is brought to reduced echelon form, it must have at least one nonzero entry, so it has a 1, in the first row. In either case, its reduced echelon form is unique.

For the inductive step we assume that  $n > 1$  and that all  $m$  row matrices with fewer than  $n$  columns have a unique reduced echelon form. Consider a  $m \times n$  matrix  $A$  and suppose that  $B$  and  $C$  are two reduced echelon form matrices derived from  $A$ . We will show that these two must be equal.

Let  $\hat{A}$  be the matrix consisting of the first  $n - 1$  columns of  $A$ . Observe that any sequence of row operations that bring  $A$  to reduced echelon form will also bring  $\hat{A}$  to reduced echelon form. By the inductive hypothesis this reduced echelon form of  $\hat{A}$  is unique, so if  $B$  and  $C$  differ then the difference must occur in their  $n$ -th columns.

We finish the inductive step, and the argument, by showing that the two cannot differ only in that column. Consider a homogeneous system of equations for which  $A$  is the matrix of coefficients.

$$\begin{aligned} a_{1,1}x_1 + a_{1,2}x_2 + \cdots + a_{1,n}x_n &= 0 \\ a_{2,1}x_1 + a_{2,2}x_2 + \cdots + a_{2,n}x_n &= 0 \\ &\vdots \\ a_{m,1}x_1 + a_{m,2}x_2 + \cdots + a_{m,n}x_n &= 0 \end{aligned} \tag{*}$$

By Theorem 1.5 the set of solutions to that system is the same as the set of solutions to this system

$$\begin{aligned} b_{1,1}x_1 + b_{1,2}x_2 + \cdots + b_{1,n}x_n &= 0 \\ b_{2,1}x_1 + b_{2,2}x_2 + \cdots + b_{2,n}x_n &= 0 \\ &\vdots \\ b_{m,1}x_1 + b_{m,2}x_2 + \cdots + b_{m,n}x_n &= 0 \end{aligned} \tag{**}$$

and to this one.

$$\begin{aligned}
 c_{1,1}x_1 + c_{1,2}x_2 + \cdots + c_{1,n}x_n &= 0 \\
 c_{2,1}x_1 + c_{2,2}x_2 + \cdots + c_{2,n}x_n &= 0 \\
 &\vdots \\
 c_{m,1}x_1 + c_{m,2}x_2 + \cdots + c_{m,n}x_n &= 0
 \end{aligned}
 \tag{***}$$

Suppose that B and C differ only in column n, in row i. Subtract row i of (\*\*\*) from row i of (\*\*). Since B and C agree on their first  $n - 1$  columns the result is the equation  $(b_{i,n} - c_{i,n}) \cdot x_n = 0$ . Because  $b_{i,n} \neq c_{i,n}$  we know that  $x_n = 0$ . Thus in (\*\*) and (\*\*\*) the n-th column has a leading 1, or else the variable  $x_n$  would be free. That's a contradiction, because with the first  $n - 1$  columns of B and C equal, the leading 1's in the n-th column would have to be in the same row. So  $B = C$ . QED

That result answers the two questions that we posed in the introduction to this section: do any two echelon form versions of a linear system have the same number of free variables, and if so are they exactly the same variables? We get from any echelon form version to the reduced echelon form by pivoting up, and so uniqueness of reduced echelon form implies that the same variables are free in all echelon form version of a system. Thus both questions are answered "yes." There is no linear system and no combination of row operations such that, say, we could solve the system one way and get  $y$  and  $z$  free but solve it another way and get  $y$  and  $w$  free.

We end this section with a recap. In Gauss' method we start with a matrix and then derive a sequence of other matrices. We defined two matrices to be related if we can derive one from the other. That relation is an equivalence relation, called row equivalence, and so partitions the set of all matrices into row equivalence classes.

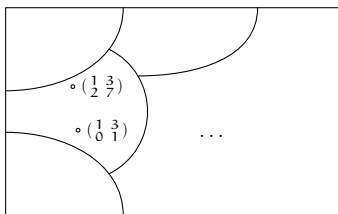

(There are infinitely many matrices in the pictured class, but we've only got room to show two.) We have proved there is one and only one reduced echelon form matrix in each row equivalence class. So the reduced echelon form is a *canonical form*\* for row equivalence: the reduced echelon form matrices are representatives of the classes.

---

\* More information on canonical representatives is in the appendix.



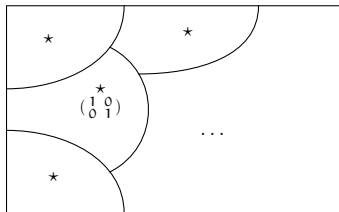

We can answer questions about the classes by translating them into questions about the representatives.

**2.6 Example** We can decide if matrices are interreducible by seeing if Gauss-Jordan reduction produces the same reduced echelon form result. Thus, these are not row equivalent

$$\begin{pmatrix} 1 & -3 \\ -2 & 6 \end{pmatrix} \quad \begin{pmatrix} 1 & -3 \\ -2 & 5 \end{pmatrix}$$

because their reduced echelon forms are not equal.

$$\begin{pmatrix} 1 & -3 \\ 0 & 0 \end{pmatrix} \quad \begin{pmatrix} 1 & 0 \\ 0 & 1 \end{pmatrix}$$

**2.7 Example** Any nonsingular  $3 \times 3$  matrix Gauss-Jordan reduces to this.

$$\begin{pmatrix} 1 & 0 & 0 \\ 0 & 1 & 0 \\ 0 & 0 & 1 \end{pmatrix}$$

**2.8 Example** We can describe the classes by listing all possible reduced echelon form matrices. Any  $2 \times 2$  matrix lies in one of these: the class of matrices row equivalent to this,

$$\begin{pmatrix} 0 & 0 \\ 0 & 0 \end{pmatrix}$$

the infinitely many classes of matrices row equivalent to one of this type

$$\begin{pmatrix} 1 & a \\ 0 & 0 \end{pmatrix}$$

where  $a \in \mathbb{R}$  (including  $a = 0$ ), the class of matrices row equivalent to this,

$$\begin{pmatrix} 0 & 1 \\ 0 & 0 \end{pmatrix}$$

and the class of matrices row equivalent to this

$$\begin{pmatrix} 1 & 0 \\ 0 & 1 \end{pmatrix}$$

(this is the class of nonsingular  $2 \times 2$  matrices).

### Exercises

✓ **2.9** Decide if the matrices are row equivalent.

$$\begin{aligned}
 \text{(a)} & \begin{pmatrix} 1 & 2 \\ 4 & 8 \end{pmatrix}, \begin{pmatrix} 0 & 1 \\ 1 & 2 \end{pmatrix} & \text{(b)} & \begin{pmatrix} 1 & 0 & 2 \\ 3 & -1 & 1 \\ 5 & -1 & 5 \end{pmatrix}, \begin{pmatrix} 1 & 0 & 2 \\ 0 & 2 & 10 \\ 2 & 0 & 4 \end{pmatrix} \\
 \text{(c)} & \begin{pmatrix} 2 & 1 & -1 \\ 1 & 1 & 0 \\ 4 & 3 & -1 \end{pmatrix}, \begin{pmatrix} 1 & 0 & 2 \\ 0 & 2 & 10 \end{pmatrix} & \text{(d)} & \begin{pmatrix} 1 & 1 & 1 \\ -1 & 2 & 2 \end{pmatrix}, \begin{pmatrix} 0 & 3 & -1 \\ 2 & 2 & 5 \end{pmatrix} \\
 \text{(e)} & \begin{pmatrix} 1 & 1 & 1 \\ 0 & 0 & 3 \end{pmatrix}, \begin{pmatrix} 0 & 1 & 2 \\ 1 & -1 & 1 \end{pmatrix}
 \end{aligned}$$

2.10 Describe the matrices in each of the classes represented in Example 2.8.

2.11 Describe all matrices in the row equivalence class of these.

$$\text{(a)} \begin{pmatrix} 1 & 0 \\ 0 & 0 \end{pmatrix} \quad \text{(b)} \begin{pmatrix} 1 & 2 \\ 2 & 4 \end{pmatrix} \quad \text{(c)} \begin{pmatrix} 1 & 1 \\ 1 & 3 \end{pmatrix}$$

2.12 How many row equivalence classes are there?

2.13 Can row equivalence classes contain different-sized matrices?

2.14 How big are the row equivalence classes?

(a) Show that for any matrix of all zeros, the class is finite.

(b) Do any other classes contain only finitely many members?

✓ 2.15 Give two reduced echelon form matrices that have their leading entries in the same columns, but that are not row equivalent.

✓ 2.16 Show that any two  $n \times n$  nonsingular matrices are row equivalent. Are any two singular matrices row equivalent?

✓ 2.17 Describe all of the row equivalence classes containing these.

(a)  $2 \times 2$  matrices    (b)  $2 \times 3$  matrices    (c)  $3 \times 2$  matrices  
 (d)  $3 \times 3$  matrices

2.18 (a) Show that a vector  $\vec{\beta}_0$  is a linear combination of members of the set  $\{\vec{\beta}_1, \dots, \vec{\beta}_n\}$  if and only if there is a linear relationship  $\vec{0} = c_0\vec{\beta}_0 + \dots + c_n\vec{\beta}_n$  where  $c_0$  is not zero. (*Hint.* Watch out for the  $\vec{\beta}_0 = \vec{0}$  case.)

(b) Use that to simplify the proof of Lemma 2.4.

✓ 2.19 [Trono] Three truck drivers went into a roadside cafe. One truck driver purchased four sandwiches, a cup of coffee, and ten doughnuts for \$8.45. Another driver purchased three sandwiches, a cup of coffee, and seven doughnuts for \$6.30. What did the third truck driver pay for a sandwich, a cup of coffee, and a doughnut?

✓ 2.20 The Linear Combination Lemma says which equations can be gotten from Gaussian reduction of a given linear system.

(1) Produce an equation not implied by this system.

$$\begin{aligned}
 3x + 4y &= 8 \\
 2x + y &= 3
 \end{aligned}$$

(2) Can any equation be derived from an inconsistent system?

2.21 [Hoffman & Kunze] Extend the definition of row equivalence to linear systems.

Under your definition, do equivalent systems have the same solution set?

✓ 2.22 In this matrix

$$\begin{pmatrix} 1 & 2 & 3 \\ 3 & 0 & 3 \\ 1 & 4 & 5 \end{pmatrix}$$

the first and second columns add to the third.

(a) Show that remains true under any row operation.

(b) Make a conjecture.

(c) Prove that it holds.

## Computer Algebra Systems

The linear systems in this chapter are small enough that their solution by hand is easy. But large systems are easiest, and safest, to do on a computer. There are special purpose programs such as LINPACK for this job. Another popular tool is a general purpose computer algebra system, including both commercial packages such as Maple, Mathematica, or MATLAB, or free packages such as Sage.

For example, in the Topic on Networks, we need to solve this.

$$\begin{array}{rcccccc}
 i_0 - i_1 - i_2 & & & & & & = 0 \\
 & i_1 & & - i_3 & & - i_5 & = 0 \\
 & & i_2 & & - i_4 & + i_5 & = 0 \\
 & & & i_3 & + i_4 & & - i_6 = 0 \\
 5i_1 & & + 10i_3 & & & & = 10 \\
 & 2i_2 & & + 4i_4 & & & = 10 \\
 5i_1 - 2i_2 & & & & + 50i_5 & & = 0
 \end{array}$$

We could do this by hand but it would take a while and be error-prone. Using a computer is better.

We illustrate by solving that system under Sage.

```

sage: var('i0,i1,i2,i3,i4,i5,i6')
(i0, i1, i2, i3, i4, i5, i6)
sage: network_system=[i0-i1-i2==0, i1-i3-i5==0,
....:      i2-i4+i5==0,, i3+i4-i6==0, 5*i1+10*i3==10,
....:      2*i2+4*i4==10, 5*i1-2*i2+50*i5==0]
sage: solve(network_system, i0,i1,i2,i3,i4,i5,i6)
[[i0 == (7/3), i1 == (2/3), i2 == (5/3), i3 == (2/3),
  i4 == (5/3), i5 == 0, i6 == (7/3)]]

```

Magic.

Here is the same system solved under Maple. We enter the array of coefficients and the vector of constants, and then we get the solution.

```

> A:=array( [[1,-1,-1,0,0,0,0],
            [0,1,0,-1,0,-1,0],
            [0,0,1,0,-1,1,0],
            [0,0,0,1,1,0,-1],
            [0,5,0,10,0,0,0],
            [0,0,2,0,4,0,0],
            [0,5,-2,0,0,50,0]] );
> u:=array( [0,0,0,0,10,10,0] );
> linsolve(A,u);

```

```

7 2 5 2 5 7
[ -, -, -, -, -, 0, - ]
3 3 3 3 3 3

```

If a system has infinitely many solutions then the program will return a parametrization.

### Exercises

1 Use the computer to solve the two problems that opened this chapter.

(a) This is the Statics problem.

$$40h + 15c = 100$$

$$25c = 50 + 50h$$

(b) This is the Chemistry problem.

$$7h = 7j$$

$$8h + 1i = 5j + 2k$$

$$1i = 3j$$

$$3i = 6j + 1k$$

2 Use the computer to solve these systems from the first subsection, or conclude 'many solutions' or 'no solutions'.

(a)  $2x + 2y = 5$     (b)  $-x + y = 1$     (c)  $x - 3y + z = 1$     (d)  $-x - y = 1$   
 $x - 4y = 0$                      $x + y = 2$                      $x + y + 2z = 14$                      $-3x - 3y = 2$

(e)  $4y + z = 20$     (f)  $2x + z + w = 5$   
 $2x - 2y + z = 0$                      $y - w = -1$   
 $x + z = 5$                      $3x - z - w = 0$   
 $x + y - z = 10$                      $4x + y + 2z + w = 9$

3 Use the computer to solve these systems from the second subsection.

(a)  $3x + 6y = 18$     (b)  $x + y = 1$     (c)  $x_1 + x_3 = 4$   
 $x + 2y = 6$                      $x - y = -1$                      $x_1 - x_2 + 2x_3 = 5$   
 $4x_1 - x_2 + 5x_3 = 17$

(d)  $2a + b - c = 2$     (e)  $x + 2y - z = 3$     (f)  $x + z + w = 4$   
 $2a + c = 3$                      $2x + y + w = 4$                      $2x + y - w = 2$   
 $a - b = 0$                      $x - y + z + w = 1$                      $3x + y + z = 7$

4 What does the computer give for the solution of the general  $2 \times 2$  system?

$$ax + cy = p$$

$$bx + dy = q$$

## Input-Output Analysis

An economy is an immensely complicated network of interdependence. Changes in one part can ripple out to affect other parts. Economists have struggled to be able to describe, and to make predictions about, such a complicated object and mathematical models using systems of linear equations have emerged as a key tool. One is Input-Output Analysis, pioneered by W. Leontief, who won the 1973 Nobel Prize in Economics.

Consider an economy with many parts, two of which are the steel industry and the auto industry. These two interact tightly as they work to meet the demand for their product from other parts of the economy, that is, from users external to the steel and auto sectors. For instance, should the external demand for autos go up, that would increase in the auto industry's usage of steel. Or, should the external demand for steel fall, then it would lead lower steel's purchase of autos. The type of Input-Output model that we will consider takes in the external demands and then predicts how the two interact to meet those demands.

We start with a listing of production and consumption statistics. (These numbers, giving dollar values in millions, are from [Leontief 1965], describing the 1958 U.S. economy. Today's statistics would be different, both because of inflation and because of technical changes in the industries.)

	<i>used by steel</i>	<i>used by auto</i>	<i>used by others</i>	<i>total</i>
<i>value of steel</i>	5 395	2 664		25 448
<i>value of auto</i>	48	9 030		30 346

For instance, the dollar value of steel used by the auto industry in this year is 2,664 million. Note that industries may consume some of their own output.

We can fill in the blanks for the external demand. This year's value of the steel used by others is 17,389 and this year's value of the auto used by others is 21,268. With that, we have a complete description of the external demands and of how auto and steel interact, this year, to meet them.

Now, imagine that the external demand for steel has recently been going up by 200 per year and so we estimate that next year it will be 17,589. We also

estimate that next year's external demand for autos will be down 25 to 21,243. We wish to predict next year's total outputs.

That prediction isn't as simple as adding 200 to this year's steel total and subtracting 25 from this year's auto total. For one thing, a rise in steel will cause that industry to have an increased demand for autos, which will mitigate to some extent the loss in external demand for autos. On the other hand, the drop in external demand for autos will cause the auto industry to use less steel and so lessen somewhat the upswing in steel's business. In short, these two industries form a system, and we need to predict where the system as a whole will settle.

We have these equations.

$$\begin{aligned} \text{next year's production of steel} &= \text{next year's use of steel by steel} \\ &\quad + \text{next year's use of steel by auto} \\ &\quad + \text{next year's use of steel by others} \\ \text{next year's production of autos} &= \text{next year's use of autos by steel} \\ &\quad + \text{next year's use of autos by auto} \\ &\quad + \text{next year's use of autos by others} \end{aligned}$$

On the left side put the unknowns  $s$  be next years total production of steel and  $a$  for next year's total output of autos. At the ends of the right sides go our external demand estimates for next year 17,589 and 21,243. For the remaining four terms, we look to the table of this year's information about how the industries interact.

For next year's use of steel by steel, we note that this year the steel industry used 5395 units of steel input to produce 25,448 units of steel output. So next year, when the steel industry will produce  $s$  units out, we expect that doing so will take  $s \cdot (5395)/(25448)$  units of steel input—this is simply the assumption that input is proportional to output. (We are assuming that the ratio of input to output remains constant over time; in practice, models may try to take account of trends of change in the ratios.)

Next year's use of steel by the auto industry is similar. This year, the auto industry uses 2664 units of steel input to produce 30346 units of auto output. So next year, when the auto industry's total output is  $a$ , we expect it to consume  $a \cdot (2664)/(30346)$  units of steel.

Filling in the other equation in the same way gives this system of linear equations.

$$\begin{aligned} \frac{5395}{25448} \cdot s + \frac{2664}{30346} \cdot a + 17589 &= s \\ \frac{48}{25448} \cdot s + \frac{9030}{30346} \cdot a + 21243 &= a \end{aligned}$$

Gauss' method

$$\begin{aligned} (20053/25448)s - (2664/30346)a &= 17589 \\ -(48/25448)s + (21316/30346)a &= 21243 \end{aligned}$$

gives  $s = 25698$  and  $a = 30311$ .

Looking back, recall that above we described why the prediction of next year's totals isn't as simple as adding 200 to last year's steel total and subtracting 25 from last year's auto total. In fact, comparing these totals for next year to the ones given at the start for the current year shows that, despite the drop in external demand, the total production of the auto industry will rise. The increase in internal demand for autos caused by steel's sharp rise in business more than makes up for the loss in external demand for autos.

One of the advantages of having a mathematical model is that we can ask "What if . . . ?" questions. For instance, we can ask "What if the estimates for next year's external demands are somewhat off?" To try to understand how much the model's predictions change in reaction to changes in our estimates, we can try revising our estimate of next year's external steel demand from 17,589 down to 17,489, while keeping the assumption of next year's external demand for autos fixed at 21,243. The resulting system

$$\begin{aligned}(20\,053/25\,448)s - (2\,664/30\,346)a &= 17\,489 \\ -(48/25\,448)s + (21\,316/30\,346)a &= 21\,243\end{aligned}$$

when solved gives  $s = 25\,571$  and  $a = 30\,311$ . This is *sensitivity analysis*. We are seeing how sensitive the predictions of our model are to the accuracy of the assumptions.

Naturally, we can consider larger models that detail the interactions among more sectors of an economy; these models are typically solved on a computer. Naturally also, a single model does not suit every case and assuring that the assumptions underlying a model are reasonable for a particular prediction requires the judgments of experts. With those caveats however, this model has proven in practice to be a useful and accurate tool for economic analysis. For further reading, try [Leontief 1951] and [Leontief 1965].

## Exercises

*Hint: these systems are easiest to solve on a computer.*

- 1 With the steel-auto system given above, estimate next year's total productions in these cases.
  - (a) Next year's external demands are: up 200 from this year for steel, and unchanged for autos.
  - (b) Next year's external demands are: up 100 for steel, and up 200 for autos.
  - (c) Next year's external demands are: up 200 for steel, and up 200 for autos.
- 2 In the steel-auto system, the ratio for the use of steel by the auto industry is  $2\,664/30\,346$ , about 0.0878. Imagine that a new process for making autos reduces this ratio to .0500.
  - (a) How will the predictions for next year's total productions change compared to the first example discussed above (i.e., taking next year's external demands to be 17,589 for steel and 21,243 for autos)?
  - (b) Predict next year's totals if, in addition, the external demand for autos rises to be 21,500 because the new cars are cheaper.

3 This table gives the numbers for the auto-steel system from a different year, 1947 (see [Leontief 1951]). The units here are billions of 1947 dollars.

	<i>used by steel</i>	<i>used by auto</i>	<i>used by others</i>	<i>total</i>
<i>value of steel</i>	6.90	1.28		18.69
<i>value of autos</i>	0	4.40		14.27

- (a) Solve for total output if next year's external demands are: steel's demand up 10% and auto's demand up 15%.
- (b) How do the ratios compare to those given above in the discussion for the 1958 economy?
- (c) Solve the 1947 equations with the 1958 external demands (note the difference in units; a 1947 dollar buys about what \$1.30 in 1958 dollars buys). How far off are the predictions for total output?
- 4 Predict next year's total productions of each of the three sectors of the hypothetical economy shown below

	<i>used by farm</i>	<i>used by rail</i>	<i>used by shipping</i>	<i>used by others</i>	<i>total</i>
<i>value of farm</i>	25	50	100		800
<i>value of rail</i>	25	50	50		300
<i>value of shipping</i>	15	10	0		500

if next year's external demands are as stated.

- (a) 625 for farm, 200 for rail, 475 for shipping
- (b) 650 for farm, 150 for rail, 450 for shipping
- 5 This table gives the interrelationships among three segments of an economy (see [Clark & Coupe]).

	<i>used by food</i>	<i>used by wholesale</i>	<i>used by retail</i>	<i>used by others</i>	<i>total</i>
<i>value of food</i>	0	2318	4679		11869
<i>value of wholesale</i>	393	1089	22459		122242
<i>value of retail</i>	3	53	75		116041

We will do an Input-Output analysis on this system.

- (a) Fill in the numbers for this year's external demands.
- (b) Set up the linear system, leaving next year's external demands blank.
- (c) Solve the system where we get next year's external demands by taking this year's external demands and inflating them 10%. Do all three sectors increase their total business by 10%? Do they all even increase at the same rate?
- (d) Solve the system where we get next year's external demands by taking this year's external demands and reducing them 7%. (The study from which these numbers come concluded that because of the closing of a local military facility, overall personal income in the area would fall 7%, so this might be a first guess at what would actually happen.)



## Accuracy of Computations

Gauss' method lends itself nicely to computerization. The code below illustrates. It operates on an  $n \times n$  matrix  $a$ , doing row combinations using the first row, then the second row, etc.

```
for(row=1;row<=n-1;row++){
  for(row_below=row+1;row_below<=n;row_below++){
    multiplier=a[row_below,row]/a[row,row];
    for(col=row; col<=n; col++){
      a[row_below,col]-=multiplier*a[row,col];
    }
  }
}
```

This is in the C language. The loop `for(row=1;row<=n-1;row++){ .. }` initializes `row` at 1 and then iterates while `row` is less than or equal to  $n - 1$ , each time through incrementing `row` by one with the `++` operation. The other non-obvious language construct is that the `'-='` in the innermost loop amounts to the `a[row_below,col] = -multiplier * a[row,col] + a[row_below,col]` operation.

This code provides a quick take on how mechanizing Gauss' method. But it is naive in many ways. For one thing, it assumes that the entry in the `row, row` position is nonzero. One way that the code needs additional development to make it practical is to cover the case where finding a zero in that location leads to a row swap or to the conclusion that the matrix is singular.

Adding some `if` statements to cover those cases is not hard, but we will instead consider some other ways in which the code is naive. It is prone to pitfalls arising from the computer's reliance on finite-precision floating point arithmetic.

For example, we have seen above that we must handle as a separate case a system that is singular. But systems that are nearly singular also require care. Consider this one.

$$\begin{aligned}x + 2y &= 3 \\ 1.000\,000\,01x + 2y &= 3.000\,000\,01\end{aligned}$$

We can easily spot the solution  $x = 1, y = 1$ . But a computer has more trouble. If it represents real numbers to eight significant places, called *single precision*, then it will represent the second equation internally as  $1.000\,000\,0x + 2y = 3.000\,000\,0$ , losing the digits in the ninth place. Instead of reporting the correct solution, this

computer will report something that is not even close—this computer thinks that the system is singular because the two equations are represented internally as equal.

For some intuition about how the computer could come up with something that far off, we graph the system.

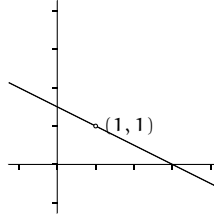

At the scale that we have drawn this graph we cannot tell the two lines apart. This system is nearly singular in the sense that the two lines are nearly the same line. Near-singularity gives this system the property that a small change in the system can cause a large change in its solution; for instance, changing the 3.000 000 01 to 3.000 000 03 changes the intersection point from (1, 1) to (3, 0). This system changes radically depending on a ninth digit, which explains why an eight-place computer has trouble. A problem that is very sensitive to inaccuracy or uncertainties in the input values is *ill-conditioned*.

The above example gives one way in which a system can be difficult to solve on a computer and it has the advantage that the picture of nearly-equal lines gives a memorable insight into one way that numerical difficulties can arise. Unfortunately this insight isn't useful when we wish to solve some large system. We cannot, typically, hope to understand the geometry of an arbitrary large system. In addition, there are ways that a computer's results may be unreliable other than that the angle between some of the linear surfaces is small.

For an example, consider the system below, from [Hamming].

$$\begin{aligned} 0.001x + y &= 1 \\ x - y &= 0 \end{aligned} \quad (*)$$

The second equation gives  $x = y$ , so  $x = y = 1/1.001$  and thus both variables have values that are just less than 1. A computer using two digits represents the system internally in this way (we will do this example in two-digit floating point arithmetic, but inventing a similar one with eight digits is easy).

$$\begin{aligned} (1.0 \times 10^{-2})x + (1.0 \times 10^0)y &= 1.0 \times 10^0 \\ (1.0 \times 10^0)x - (1.0 \times 10^0)y &= 0.0 \times 10^0 \end{aligned}$$

The computer's row reduction step  $-1000\rho_1 + \rho_2$  produces a second equation  $-1001y = -999$ , which the computer rounds to two places as  $(-1.0 \times 10^3)y = -1.0 \times 10^3$ . Then the computer decides from the second equation that  $y = 1$  and from the first equation that  $x = 0$ . This  $y$  value is fairly good, but the  $x$  is very bad. Thus, another cause of unreliable output is a mixture of floating point arithmetic and a reliance on using leading entries that are small.

An experienced programmer may respond by going to *double precision* that retains sixteen significant digits. This will indeed solve many problems. However, double precision has twice the memory requirements and besides, we can obviously tweak the above systems to give the same trouble in the seventeenth digit, so double precision isn't a panacea. We need a strategy to minimize the numerical trouble arising from solving systems on a computer as well as some guidance as to how far we can trust the reported solutions.

A basic improvement on the naive code above is to not simply take the entry in the *row*, *row* position to determine the factor to use for the row combination, but rather to look at all of the entries in the *row* column below the *row*, *row* entry and take the one that is most likely to give reliable results (e.g., take one that is not too small). This is *partial pivoting*.

For example, to solve the troublesome system (\*) above, we start by looking at both equations for a best entry to use, and taking the 1 in the second equation as more likely to give good results. Then, the combination step of  $-.001\rho_2 + \rho_1$  gives a first equation of  $1.001y = 1$ , which the computer will represent as  $(1.0 \times 10^0)y = 1.0 \times 10^0$ , leading to the conclusion that  $y = 1$  and, after back-substitution,  $x = 1$ , both of which are close to right. We can adapt the code from above to this purpose.

```
for(row=1;row<=n-1;row++){
/* find the largest entry in this column (in row max) */
max=row;
for(row_below=row+1;row_below<=n;row_below++){
if (abs(a[row_below,row]) > abs(a[max,row]));
max = row_below;
}
/* swap rows to move that best entry up */
for(col=row;col<=n;col++){
temp=a[row,col];
a[row,col]=a[max,col];
a[max,col]=temp;
}
/* proceed as before */
for(row_below=row+1;row_below<=n;row_below++){
multiplier=a[row_below,row]/a[row,row];
for(col=row;col<=n;col++){
a[row_below,col]-=multiplier*a[row,col];
}
}
}
```

A full analysis of the best way to implement Gauss' method is outside the scope of the book (see [Wilkinson 1965]), but the method recommended by most experts first finds the best entry among the candidates and then scales it to a number that is less likely to give trouble. This is *scaled partial pivoting*.

In addition to returning a result that is likely to be reliable, most well-done code will return a number, the *conditioning number* that describes the factor by which uncertainties in the input numbers could be magnified to become inaccuracies in the results returned (see [Rice]).

The lesson is that, just because Gauss' method always works in theory, and just because computer code correctly implements that method, doesn't mean that the answer is reliable. In practice, always use a package where experts have

worked hard to counter what can go wrong.

### Exercises

- 1 Using two decimal places, add 253 and  $2/3$ .
- 2 This intersect-the-lines problem contrasts with the example discussed above.

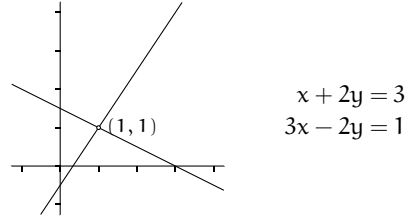

Illustrate that in this system some small change in the numbers will produce only a small change in the solution by changing the constant in the bottom equation to 1.008 and solving. Compare it to the solution of the unchanged system.

- 3 Solve this system by hand ([Rice]).

$$\begin{aligned} 0.0003x + 1.556y &= 1.569 \\ 0.3454x - 2.346y &= 1.018 \end{aligned}$$

- (a) Solve it accurately, by hand.
  - (b) Solve it by rounding at each step to four significant digits.
- 4 Rounding inside the computer often has an effect on the result. Assume that your machine has eight significant digits.
  - (a) Show that the machine will compute  $(2/3) + ((2/3) - (1/3))$  as unequal to  $((2/3) + (2/3)) - (1/3)$ . Thus, computer arithmetic is not associative.
  - (b) Compare the computer's version of  $(1/3)x + y = 0$  and  $(2/3)x + 2y = 0$ . Is twice the first equation the same as the second?
- 5 Ill-conditioning is not only dependent on the matrix of coefficients. This example [Hamming] shows that it can arise from an interaction between the left and right sides of the system. Let  $\varepsilon$  be a small real.

$$\begin{aligned} 3x + 2y + z &= 6 \\ 2x + 2\varepsilon y + 2\varepsilon z &= 2 + 4\varepsilon \\ x + 2\varepsilon y - \varepsilon z &= 1 + \varepsilon \end{aligned}$$

- (a) Solve the system by hand. Notice that the  $\varepsilon$ 's divide out only because there is an exact cancellation of the integer parts on the right side as well as on the left.
  - (b) Solve the system by hand, rounding to two decimal places, and with  $\varepsilon = 0.001$ .

## Analyzing Networks

The diagram below shows some of a car's electrical network. The battery is on the left, drawn as stacked line segments. The wires are lines, shown straight and with sharp right angles for neatness. Each light is a circle enclosing a loop.

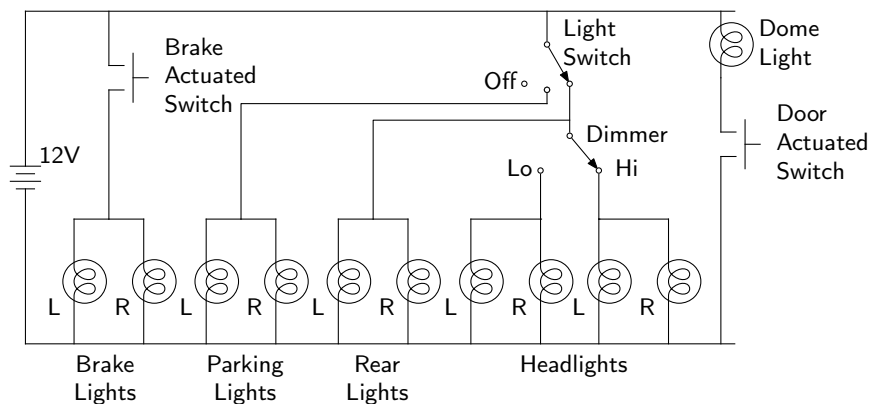

The designer of such a network needs to answer questions like: How much electricity flows when both the hi-beam headlights and the brake lights are on? We will use linear systems to analyze simple electrical networks.

For the analysis we need two facts about electricity and two facts about electrical networks.

The first fact about electricity is that a battery is like a pump, providing a force impelling the electricity to flow, if there is a path. We say that the battery provides a *potential* to flow. For instance, when the driver steps on the brake then the switch makes contact and so makes a circuit on the left side of the diagram, so the battery's force creates a current flowing through that circuit to turn on the brake lights.

The second electrical fact is that in some kinds of network components the amount of flow is proportional to the force provided by the battery. That is, for each such component there is a number, it's *resistance*, such that the potential is equal to the flow times the resistance. Potential is measured in *volts*, the rate of flow is in *amperes*, and resistance to the flow is in *ohms*; these units are defined so that  $\text{volts} = \text{amperes} \cdot \text{ohms}$ .

Components with this property, that the voltage-amperage response curve is a line through the origin, are *resistors*. For example, if a resistor measures 2 ohms then wiring it to a 12 volt battery results in a flow of 6 amperes. Conversely, if electrical current of 2 amperes flows through that resistor then there must be a 4 volt potential difference between it's ends. This is the *voltage drop* across the resistor. One way to think of the electrical circuits that we consider here is that the battery provides a voltage rise while the other components are voltage drops.

The two facts that we need about networks are Kirchhoff's Laws.

*Current Law.* For any point in a network, the flow in equals the flow out.

*Voltage Law.* Around any circuit the total drop equals the total rise.

We start with the network below. It has a battery that provides the potential to flow and three resistors, drawn as zig-zags. When components are wired one after another, as here, they are in *series*.

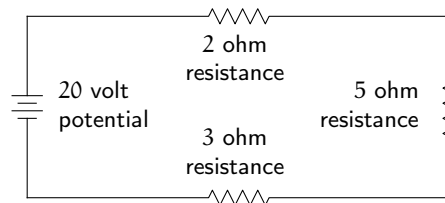

By Kirchhoff's Voltage Law, because the voltage rise is 20 volts, the total voltage drop must also be 20 volts. Since the resistance from start to finish is 10 ohms (the resistance of the wire connecting the components is negligible), the current is  $(20/10) = 2$  amperes. Now, by Kirchhoff's Current Law, there are 2 amperes through each resistor. Therefore the voltage drops are: 4 volts across the 2 ohm resistor, 10 volts across the 5 ohm resistor, and 6 volts across the 3 ohm resistor.

The prior network is simple enough that we didn't use a linear system but the next one is more complicated. Here the resistors are in *parallel*.

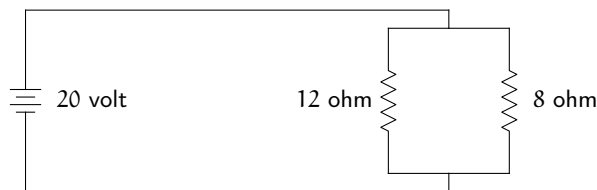

We begin by labeling the branches as below. Let the current through the left branch of the parallel portion be  $i_1$  and that through the right branch be  $i_2$ , and also let the current through the battery be  $i_0$ . Note that we don't need to know the actual direction of flow — if current flows in the direction opposite to our arrow then we will get a negative number in the solution.



The Current Law, applied to the point in the upper right where the flow  $i_0$  meets  $i_1$  and  $i_2$ , gives that  $i_0 = i_1 + i_2$ . Applied to the lower right it gives  $i_1 + i_2 = i_0$ . In the circuit that loops out of the top of the battery, down the left branch of the parallel portion, and back into the bottom of the battery, the voltage rise is 20 while the voltage drop is  $i_1 \cdot 12$ , so the Voltage Law gives that  $12i_1 = 20$ . Similarly, the circuit from the battery to the right branch and back to the battery gives that  $8i_2 = 20$ . And, in the circuit that simply loops around in the left and right branches of the parallel portion (taken clockwise, arbitrarily), there is a voltage rise of 0 and a voltage drop of  $8i_2 - 12i_1$  so the Voltage Law gives that  $8i_2 - 12i_1 = 0$ .

$$\begin{aligned} i_0 - i_1 - i_2 &= 0 \\ -i_0 + i_1 + i_2 &= 0 \\ 12i_1 &= 20 \\ 8i_2 &= 20 \\ -12i_1 + 8i_2 &= 0 \end{aligned}$$

The solution is  $i_0 = 25/6$ ,  $i_1 = 5/3$ , and  $i_2 = 5/2$ , all in amperes. (Incidentally, this illustrates that redundant equations can arise in practice.)

Kirchhoff's laws can establish the electrical properties of very complex networks. The next diagram shows five resistors, wired in a *series-parallel* way.

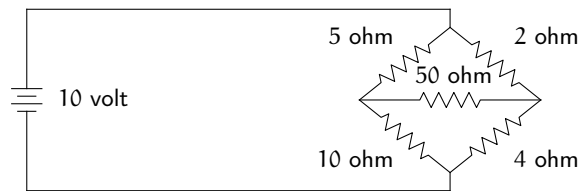

This network is a *Wheatstone bridge* (see Exercise 4). To analyze it, we can place the arrows in this way.

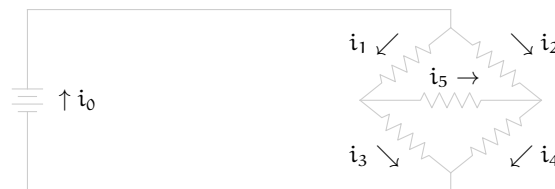

Kirchhoff's Current Law, applied to the top node, the left node, the right node, and the bottom node gives these.

$$\begin{aligned}i_0 &= i_1 + i_2 \\i_1 &= i_3 + i_5 \\i_2 + i_5 &= i_4 \\i_3 + i_4 &= i_0\end{aligned}$$

Kirchhoff's Voltage Law, applied to the inside loop (the  $i_0$  to  $i_1$  to  $i_3$  to  $i_0$  loop), the outside loop, and the upper loop not involving the battery, gives these.

$$\begin{aligned}5i_1 + 10i_3 &= 10 \\2i_2 + 4i_4 &= 10 \\5i_1 + 50i_5 - 2i_2 &= 0\end{aligned}$$

Those suffice to determine the solution  $i_0 = 7/3$ ,  $i_1 = 2/3$ ,  $i_2 = 5/3$ ,  $i_3 = 2/3$ ,  $i_4 = 5/3$ , and  $i_5 = 0$ .

We can understand many kinds of networks in this way. For instance, the exercises analyze some networks of streets.

### Exercises

1 Calculate the amperages in each part of each network.

(a) This is a simple network.

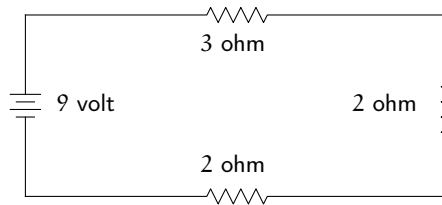

(b) Compare this one with the parallel case discussed above.

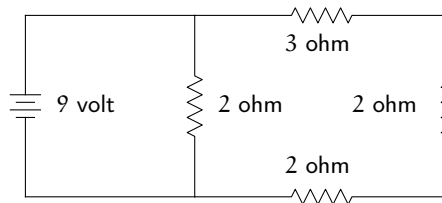

(c) This is a reasonably complicated network.

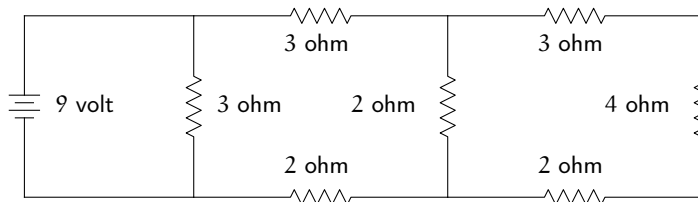

2 In the first network that we analyzed, with the three resistors in series, we just added to get that they acted together like a single resistor of 10 ohms. We can do



a similar thing for parallel circuits. In the second circuit analyzed,

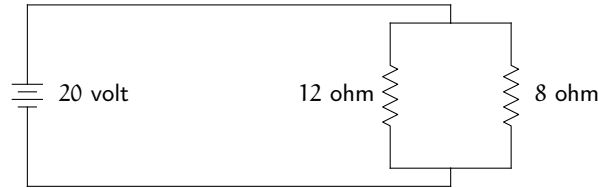

the electric current through the battery is  $25/6$  amperes. Thus, the parallel portion is *equivalent* to a single resistor of  $20/(25/6) = 4.8$  ohms.

- (a) What is the equivalent resistance if we change the 12 ohm resistor to 5 ohms?
  - (b) What is the equivalent resistance if the two are each 8 ohms?
  - (c) Find the formula for the equivalent resistance if the two resistors in parallel are  $r_1$  ohms and  $r_2$  ohms.
- 3 For the car dashboard example that opens this Topic, solve for these amperages (assume that all resistances are 2 ohms).
- (a) If the driver is stepping on the brakes, so the brake lights are on, and no other circuit is closed.
  - (b) If the hi-beam headlights and the brake lights are on.
- 4 Show that, in this Wheatstone Bridge,



$r_2/r_1$  equals  $r_4/r_3$  if and only if the current flowing through  $r_g$  is zero. (In practice, we place an unknown resistance at  $r_4$ . At  $r_g$  we place a meter that shows the current. We vary the three resistances  $r_1$ ,  $r_2$ , and  $r_3$  (typically they each have a calibrated knob) until the current in the middle reads 0, and then the above equation gives the value of  $r_4$ .)

*There are networks other than electrical ones, and we can ask how well Kirchhoff's laws apply to them. The remaining questions consider an extension to networks of streets.*

- 5 Consider this traffic circle.

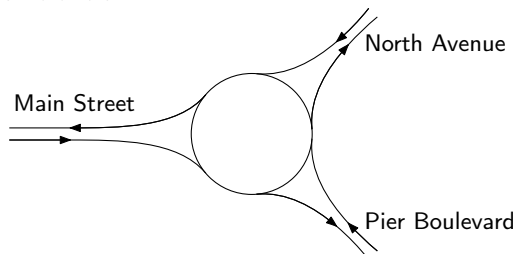

This is the traffic volume, in units of cars per five minutes.

	<i>North</i>	<i>Pier</i>	<i>Main</i>
<i>into</i>	100	150	25
<i>out of</i>	75	150	50

We can set up equations to model how the traffic flows.

- (a) Adapt Kirchhoff's Current Law to this circumstance. Is it a reasonable modeling assumption?

- (b) Label the three between-road arcs in the circle with a variable. Using the (adapted) Current Law, for each of the three in-out intersections state an equation describing the traffic flow at that node.
- (c) Solve that system.
- (d) Interpret your solution.
- (e) Restate the Voltage Law for this circumstance. How reasonable is it?
- 6 This is a network of streets.

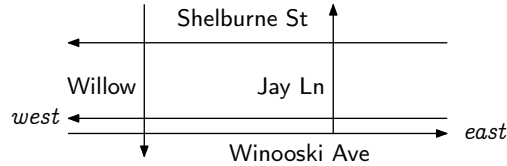

We can observe the hourly flow of cars into this network's entrances, and out of its exits.

	east Winooski	west Winooski	Willow	Jay	Shelburne
into	80	50	65	–	40
out of	30	5	70	55	75

(Note that to reach Jay a car must enter the network via some other road first, which is why there is no 'into Jay' entry in the table. Note also that over a long period of time, the total in must approximately equal the total out, which is why both rows add to 235 cars.) Once inside the network, the traffic may flow in different ways, perhaps filling Willow and leaving Jay mostly empty, or perhaps flowing in some other way. Kirchhoff's Laws give the limits on that freedom.

- (a) Determine the restrictions on the flow inside this network of streets by setting up a variable for each block, establishing the equations, and solving them. Notice that some streets are one-way only. (*Hint*: this will not yield a unique solution, since traffic can flow through this network in various ways; you should get at least one free variable.)
- (b) Suppose that someone proposes construction for Winooski Avenue East between Willow and Jay, and traffic on that block will be reduced. What is the least amount of traffic flow that we can allow on that block without disrupting the hourly flow into and out of the network?

## Chapter Two

---

# Vector Spaces

The first chapter began by introducing Gauss' method and finished with a fair understanding, keyed on the Linear Combination Lemma, of how it finds the solution set of a linear system. Gauss' method systematically takes linear combinations of the rows. With that insight, we now move to a general study of linear combinations.

We need a setting. At times in the first chapter we've combined vectors from  $\mathbb{R}^2$ , at other times vectors from  $\mathbb{R}^3$ , and at other times vectors from even higher-dimensional spaces. So our first impulse might be to work in  $\mathbb{R}^n$ , leaving  $n$  unspecified. This would have the advantage that any of the results would hold for  $\mathbb{R}^2$  and for  $\mathbb{R}^3$  and for many other spaces, simultaneously.

But if having the results apply to many spaces at once is advantageous then sticking only to  $\mathbb{R}^n$ 's is overly restrictive. We'd like the results to also apply to combinations of row vectors, as in the final section of the first chapter. We've even seen some spaces that are not just a collection of all of the same-sized column vectors or row vectors. For instance, we've seen an example of a homogeneous system's solution set that is a plane, inside of  $\mathbb{R}^3$ . This solution set is a closed system in the sense that a linear combination of these solutions is also a solution. But it is not just a collection of all of the three-tall column vectors; only some of them are in the set.

We want the results about linear combinations to apply anywhere that linear combinations are sensible. We shall call any such set a *vector space*. Our results, instead of being phrased as "Whenever we have a collection in which we can sensibly take linear combinations . . .", will be stated as "In any vector space . . .".

Such a statement describes at once what happens in many spaces. To understand the advantages of moving from studying a single space at a time to studying a class of spaces, consider this analogy. Imagine that the government made laws one person at a time: "Leslie Jones can't jay walk." That would be a bad idea; statements have the virtue of economy when they apply to many cases at once. Or suppose that they ruled, "Kim Ke must stop when passing an accident." Contrast that with, "Any doctor must stop when passing an accident." More general statements, in some ways, are clearer.

# I Definition of Vector Space

We shall study structures with two operations, an addition and a scalar multiplication, that are subject to some simple conditions. We will reflect more on the conditions later, but on first reading notice how reasonable they are. For instance, surely any operation that can be called an addition (e.g., column vector addition, row vector addition, or real number addition) will satisfy conditions (1) through (5) below.

## I.1 Definition and Examples

**1.1 Definition** A *vector space* (over  $\mathbb{R}$ ) consists of a set  $V$  along with two operations ‘+’ and ‘·’ subject to these conditions.

Where  $\vec{v}, \vec{w} \in V$ , (1) their *vector sum*  $\vec{v} + \vec{w}$  is an element of  $V$ . If  $\vec{u}, \vec{v}, \vec{w} \in V$  then (2)  $\vec{v} + \vec{w} = \vec{w} + \vec{v}$  and (3)  $(\vec{v} + \vec{w}) + \vec{u} = \vec{v} + (\vec{w} + \vec{u})$ . (4) There is a *zero vector*  $\vec{0} \in V$  such that  $\vec{v} + \vec{0} = \vec{v}$  for all  $\vec{v} \in V$ . (5) Each  $\vec{v} \in V$  has an *additive inverse*  $\vec{w} \in V$  such that  $\vec{w} + \vec{v} = \vec{0}$ .

If  $r, s$  are *scalars*, members of  $\mathbb{R}$ , and  $\vec{v}, \vec{w} \in V$  then (6) each *scalar multiple*  $r \cdot \vec{v}$  is in  $V$ . If  $r, s \in \mathbb{R}$  and  $\vec{v}, \vec{w} \in V$  then (7)  $(r + s) \cdot \vec{v} = r \cdot \vec{v} + s \cdot \vec{v}$ , and (8)  $r \cdot (\vec{v} + \vec{w}) = r \cdot \vec{v} + r \cdot \vec{w}$ , and (9)  $(rs) \cdot \vec{v} = r \cdot (s \cdot \vec{v})$ , and (10)  $1 \cdot \vec{v} = \vec{v}$ .

**1.2 Remark** The definition involves two kinds of addition and two kinds of multiplication and so may at first seem confused. For instance, in condition (7) the ‘+’ on the left is addition between two real numbers while the ‘+’ on the right represents vector addition in  $V$ . These expressions aren’t ambiguous because, for example,  $r$  and  $s$  are real numbers so ‘ $r + s$ ’ can only mean real number addition.

The best way to go through the examples below is to check all ten conditions in the definition. We write that check out at length in the first example. Use it as a model for the others. Especially important are the *closure* conditions, (1) and (6). They specify that the addition and scalar multiplication operations are always sensible—they are defined for every pair of vectors and every scalar and vector, and the result of the operation is a member of the set (see Example 1.4).

**1.3 Example** The set  $\mathbb{R}^2$  is a vector space if the operations ‘+’ and ‘·’ have their usual meaning.

$$\begin{pmatrix} x_1 \\ x_2 \end{pmatrix} + \begin{pmatrix} y_1 \\ y_2 \end{pmatrix} = \begin{pmatrix} x_1 + y_1 \\ x_2 + y_2 \end{pmatrix} \quad r \cdot \begin{pmatrix} x_1 \\ x_2 \end{pmatrix} = \begin{pmatrix} rx_1 \\ rx_2 \end{pmatrix}$$

We shall check all of the conditions.

There are five conditions in item (1). For (1), closure of addition, note that

for any  $v_1, v_2, w_1, w_2 \in \mathbb{R}$  the result of the sum

$$\begin{pmatrix} v_1 \\ v_2 \end{pmatrix} + \begin{pmatrix} w_1 \\ w_2 \end{pmatrix} = \begin{pmatrix} v_1 + w_1 \\ v_2 + w_2 \end{pmatrix}$$

is a column array with two real entries, and so is in  $\mathbb{R}^2$ . For (2), that addition of vectors commutes, take all entries to be real numbers and compute

$$\begin{pmatrix} v_1 \\ v_2 \end{pmatrix} + \begin{pmatrix} w_1 \\ w_2 \end{pmatrix} = \begin{pmatrix} v_1 + w_1 \\ v_2 + w_2 \end{pmatrix} = \begin{pmatrix} w_1 + v_1 \\ w_2 + v_2 \end{pmatrix} = \begin{pmatrix} w_1 \\ w_2 \end{pmatrix} + \begin{pmatrix} v_1 \\ v_2 \end{pmatrix}$$

(the second equality follows from the fact that the components of the vectors are real numbers, and the addition of real numbers is commutative). Condition (3), associativity of vector addition, is similar.

$$\begin{aligned} \left( \begin{pmatrix} v_1 \\ v_2 \end{pmatrix} + \begin{pmatrix} w_1 \\ w_2 \end{pmatrix} \right) + \begin{pmatrix} u_1 \\ u_2 \end{pmatrix} &= \begin{pmatrix} (v_1 + w_1) + u_1 \\ (v_2 + w_2) + u_2 \end{pmatrix} \\ &= \begin{pmatrix} v_1 + (w_1 + u_1) \\ v_2 + (w_2 + u_2) \end{pmatrix} \\ &= \begin{pmatrix} v_1 \\ v_2 \end{pmatrix} + \left( \begin{pmatrix} w_1 \\ w_2 \end{pmatrix} + \begin{pmatrix} u_1 \\ u_2 \end{pmatrix} \right) \end{aligned}$$

For the fourth condition we must produce a zero element—the vector of zeroes is it.

$$\begin{pmatrix} v_1 \\ v_2 \end{pmatrix} + \begin{pmatrix} 0 \\ 0 \end{pmatrix} = \begin{pmatrix} v_1 \\ v_2 \end{pmatrix}$$

For (5), to produce an additive inverse, note that for any  $v_1, v_2 \in \mathbb{R}$  we have

$$\begin{pmatrix} -v_1 \\ -v_2 \end{pmatrix} + \begin{pmatrix} v_1 \\ v_2 \end{pmatrix} = \begin{pmatrix} 0 \\ 0 \end{pmatrix}$$

so the first vector is the desired additive inverse of the second.

The checks for the five conditions having to do with scalar multiplication are just as routine. For (6), closure under scalar multiplication, where  $r, v_1, v_2 \in \mathbb{R}$ ,

$$r \cdot \begin{pmatrix} v_1 \\ v_2 \end{pmatrix} = \begin{pmatrix} rv_1 \\ rv_2 \end{pmatrix}$$

is a column array with two real entries, and so is in  $\mathbb{R}^2$ . Next, this checks (7).

$$(r + s) \cdot \begin{pmatrix} v_1 \\ v_2 \end{pmatrix} = \begin{pmatrix} (r + s)v_1 \\ (r + s)v_2 \end{pmatrix} = \begin{pmatrix} rv_1 + sv_1 \\ rv_2 + sv_2 \end{pmatrix} = r \cdot \begin{pmatrix} v_1 \\ v_2 \end{pmatrix} + s \cdot \begin{pmatrix} v_1 \\ v_2 \end{pmatrix}$$

For (8), that scalar multiplication distributes from the left over vector addition, we have this.

$$r \cdot \left( \begin{pmatrix} v_1 \\ v_2 \end{pmatrix} + \begin{pmatrix} w_1 \\ w_2 \end{pmatrix} \right) = \begin{pmatrix} r(v_1 + w_1) \\ r(v_2 + w_2) \end{pmatrix} = \begin{pmatrix} rv_1 + rw_1 \\ rv_2 + rw_2 \end{pmatrix} = r \cdot \begin{pmatrix} v_1 \\ v_2 \end{pmatrix} + r \cdot \begin{pmatrix} w_1 \\ w_2 \end{pmatrix}$$

The ninth

$$(rs) \cdot \begin{pmatrix} v_1 \\ v_2 \end{pmatrix} = \begin{pmatrix} (rs)v_1 \\ (rs)v_2 \end{pmatrix} = \begin{pmatrix} r(sv_1) \\ r(sv_2) \end{pmatrix} = r \cdot (s \cdot \begin{pmatrix} v_1 \\ v_2 \end{pmatrix})$$

and tenth conditions are also straightforward.

$$1 \cdot \begin{pmatrix} v_1 \\ v_2 \end{pmatrix} = \begin{pmatrix} 1v_1 \\ 1v_2 \end{pmatrix} = \begin{pmatrix} v_1 \\ v_2 \end{pmatrix}$$

In a similar way, each  $\mathbb{R}^n$  is a vector space with the usual operations of vector addition and scalar multiplication. (In  $\mathbb{R}^1$ , we usually do not write the members as column vectors, i.e., we usually do not write ' $(\pi)$ '. Instead we just write ' $\pi$ '.)

**1.4 Example** This subset of  $\mathbb{R}^3$  that is a plane through the origin

$$P = \left\{ \begin{pmatrix} x \\ y \\ z \end{pmatrix} \mid x + y + z = 0 \right\}$$

is a vector space if '+' and '.' are interpreted in this way.

$$\begin{pmatrix} x_1 \\ y_1 \\ z_1 \end{pmatrix} + \begin{pmatrix} x_2 \\ y_2 \\ z_2 \end{pmatrix} = \begin{pmatrix} x_1 + x_2 \\ y_1 + y_2 \\ z_1 + z_2 \end{pmatrix} \quad r \cdot \begin{pmatrix} x \\ y \\ z \end{pmatrix} = \begin{pmatrix} rx \\ ry \\ rz \end{pmatrix}$$

The addition and scalar multiplication operations here are just the ones of  $\mathbb{R}^3$ , reused on its subset  $P$ . We say that  $P$  *inherits* these operations from  $\mathbb{R}^3$ . This example of an addition in  $P$

$$\begin{pmatrix} 1 \\ 1 \\ -2 \end{pmatrix} + \begin{pmatrix} -1 \\ 0 \\ 1 \end{pmatrix} = \begin{pmatrix} 0 \\ 1 \\ -1 \end{pmatrix}$$

illustrates that  $P$  is closed under addition. We've added two vectors from  $P$ —that is, with the property that the sum of their three entries is zero—and the result is a vector also in  $P$ . Of course, this example of closure is not a proof of closure. To prove that  $P$  is closed under addition, take two elements of  $P$ .

$$\begin{pmatrix} x_1 \\ y_1 \\ z_1 \end{pmatrix} \quad \begin{pmatrix} x_2 \\ y_2 \\ z_2 \end{pmatrix}$$

Membership in  $P$  means that  $x_1 + y_1 + z_1 = 0$  and  $x_2 + y_2 + z_2 = 0$ . Observe that their sum

$$\begin{pmatrix} x_1 + x_2 \\ y_1 + y_2 \\ z_1 + z_2 \end{pmatrix}$$

is also in  $P$  since its entries add  $(x_1 + x_2) + (y_1 + y_2) + (z_1 + z_2) = (x_1 + y_1 + z_1) + (x_2 + y_2 + z_2)$  to 0. To show that  $P$  is closed under scalar multiplication, start with a vector from  $P$

$$\begin{pmatrix} x \\ y \\ z \end{pmatrix}$$

where  $x + y + z = 0$ , and then for  $r \in \mathbb{R}$  observe that the scalar multiple

$$r \cdot \begin{pmatrix} x \\ y \\ z \end{pmatrix} = \begin{pmatrix} rx \\ ry \\ rz \end{pmatrix}$$

gives  $rx + ry + rz = r(x + y + z) = 0$ . Thus the two closure conditions are satisfied. Verification of the other conditions in the definition of a vector space are just as straightforward.

**1.5 Example** Example 1.3 shows that the set of all two-tall vectors with real entries is a vector space. Example 1.4 gives a subset of an  $\mathbb{R}^n$  that is also a vector space. In contrast with those two, consider the set of two-tall columns with entries that are integers (under the obvious operations). This is a subset of a vector space but it is not itself a vector space. The reason is that this set is not closed under scalar multiplication, that is, it does not satisfy condition (6). Here is a column with integer entries and a scalar such that the outcome of the operation

$$0.5 \cdot \begin{pmatrix} 4 \\ 3 \end{pmatrix} = \begin{pmatrix} 2 \\ 1.5 \end{pmatrix}$$

is not a member of the set, since its entries are not all integers.

**1.6 Example** The singleton set

$$\left\{ \begin{pmatrix} 0 \\ 0 \\ 0 \\ 0 \end{pmatrix} \right\}$$

is a vector space under the operations

$$\begin{pmatrix} 0 \\ 0 \\ 0 \\ 0 \end{pmatrix} + \begin{pmatrix} 0 \\ 0 \\ 0 \\ 0 \end{pmatrix} = \begin{pmatrix} 0 \\ 0 \\ 0 \\ 0 \end{pmatrix} \quad r \cdot \begin{pmatrix} 0 \\ 0 \\ 0 \\ 0 \end{pmatrix} = \begin{pmatrix} 0 \\ 0 \\ 0 \\ 0 \end{pmatrix}$$

that it inherits from  $\mathbb{R}^4$ .

A vector space must have at least one element, its zero vector. Thus a one-element vector space is the smallest possible.

**1.7 Definition** A one-element vector space is a *trivial* space.

The examples so far involve sets of column vectors with the usual operations. But vector spaces need not be collections of column vectors, or even of row vectors. Below are some other types of vector spaces. The term ‘vector space’ does not mean ‘collection of columns of reals’. It means something more like ‘collection in which any linear combination is sensible’.

**1.8 Example** Consider  $\mathcal{P}_3 = \{a_0 + a_1x + a_2x^2 + a_3x^3 \mid a_0, \dots, a_3 \in \mathbb{R}\}$ , the set of polynomials of degree three or less (in this book, we’ll take constant polynomials, including the zero polynomial, to be of degree zero). It is a vector space under the operations

$$\begin{aligned} (a_0 + a_1x + a_2x^2 + a_3x^3) + (b_0 + b_1x + b_2x^2 + b_3x^3) \\ = (a_0 + b_0) + (a_1 + b_1)x + (a_2 + b_2)x^2 + (a_3 + b_3)x^3 \end{aligned}$$

and

$$r \cdot (a_0 + a_1x + a_2x^2 + a_3x^3) = (ra_0) + (ra_1)x + (ra_2)x^2 + (ra_3)x^3$$

(the verification is easy). This vector space is worthy of attention because these are the polynomial operations familiar from high school algebra. For instance,  $3 \cdot (1 - 2x + 3x^2 - 4x^3) - 2 \cdot (2 - 3x + x^2 - (1/2)x^3) = -1 + 7x^2 - 11x^3$ .

Although this space is not a subset of any  $\mathbb{R}^n$ , there is a sense in which we can think of  $\mathcal{P}_3$  as “the same” as  $\mathbb{R}^4$ . If we identify these two space’s elements in this way

$$a_0 + a_1x + a_2x^2 + a_3x^3 \quad \text{corresponds to} \quad \begin{pmatrix} a_0 \\ a_1 \\ a_2 \\ a_3 \end{pmatrix}$$

then the operations also correspond. Here is an example of corresponding additions.

$$\begin{array}{r} 1 - 2x + 0x^2 + 1x^3 \\ + \quad 2 + 3x + 7x^2 - 4x^3 \\ \hline 3 + 1x + 7x^2 - 3x^3 \end{array} \quad \text{corresponds to} \quad \begin{pmatrix} 1 \\ -2 \\ 0 \\ 1 \end{pmatrix} + \begin{pmatrix} 2 \\ 3 \\ 7 \\ -4 \end{pmatrix} = \begin{pmatrix} 3 \\ 1 \\ 7 \\ -3 \end{pmatrix}$$

Things we are thinking of as “the same” add to “the same” sum. Chapter Three makes precise this idea of vector space correspondence. For now we shall just leave it as an intuition.

**1.9 Example** The set  $\mathcal{M}_{2 \times 2}$  of  $2 \times 2$  matrices with real number entries is a vector space under the natural entry-by-entry operations.

$$\begin{pmatrix} a & b \\ c & d \end{pmatrix} + \begin{pmatrix} w & x \\ y & z \end{pmatrix} = \begin{pmatrix} a+w & b+x \\ c+y & d+z \end{pmatrix} \quad r \cdot \begin{pmatrix} a & b \\ c & d \end{pmatrix} = \begin{pmatrix} ra & rb \\ rc & rd \end{pmatrix}$$

As in the prior example, we can think of this space as “the same” as  $\mathbb{R}^4$ .



**1.10 Example** The set  $\{f \mid f: \mathbb{N} \rightarrow \mathbb{R}\}$  of all real-valued functions of one natural number variable is a vector space under the operations

$$(f_1 + f_2)(n) = f_1(n) + f_2(n) \quad (r \cdot f)(n) = r f(n)$$

so that if, for example,  $f_1(n) = n^2 + 2 \sin(n)$  and  $f_2(n) = -\sin(n) + 0.5$  then  $(f_1 + 2f_2)(n) = n^2 + 1$ .

We can view this space as a generalization of Example 1.3—instead of 2-tall vectors, these functions are like infinitely-tall vectors.

n	$f(n) = n^2 + 1$	corresponds to	$\begin{pmatrix} 1 \\ 2 \\ 5 \\ 10 \\ \vdots \end{pmatrix}$
0	1		
1	2		
2	5		
3	10		
$\vdots$	$\vdots$		

Addition and scalar multiplication are component-wise, as in Example 1.3. (We can formalize “infinitely-tall” by saying that it means an infinite sequence, or that it means a function from  $\mathbb{N}$  to  $\mathbb{R}$ .)

**1.11 Example** The set of polynomials with real coefficients

$$\{a_0 + a_1x + \cdots + a_nx^n \mid n \in \mathbb{N} \text{ and } a_0, \dots, a_n \in \mathbb{R}\}$$

makes a vector space when given the natural ‘+’

$$\begin{aligned} (a_0 + a_1x + \cdots + a_nx^n) + (b_0 + b_1x + \cdots + b_nx^n) \\ = (a_0 + b_0) + (a_1 + b_1)x + \cdots + (a_n + b_n)x^n \end{aligned}$$

and ‘·’.

$$r \cdot (a_0 + a_1x + \cdots + a_nx^n) = (ra_0) + (ra_1)x + \cdots + (ra_n)x^n$$

This space differs from the space  $\mathcal{P}_3$  of Example 1.8. This space contains not just degree three polynomials, but degree thirty polynomials and degree three hundred polynomials, too. Each individual polynomial of course is of a finite degree, but the set has no single bound on the degree of all of its members.

We can think of this example, like the prior one, in terms of infinite-tuples. For instance, we can think of  $1 + 3x + 5x^2$  as corresponding to  $(1, 3, 5, 0, 0, \dots)$ . However, this space differs from the one in Example 1.10. Here, each member of the set has a finite degree, that is, under the correspondence there is no element from this space matching  $(1, 2, 5, 10, \dots)$ . Vectors in this space correspond to infinite-tuples that end in zeroes.

**1.12 Example** The set  $\{f \mid f: \mathbb{R} \rightarrow \mathbb{R}\}$  of all real-valued functions of one real variable is a vector space under these.

$$(f_1 + f_2)(x) = f_1(x) + f_2(x) \quad (r \cdot f)(x) = r f(x)$$

The difference between this and Example 1.10 is the domain of the functions.

**1.13 Example** The set  $F = \{a \cos \theta + b \sin \theta \mid a, b \in \mathbb{R}\}$  of real-valued functions of the real variable  $\theta$  is a vector space under the operations

$$(a_1 \cos \theta + b_1 \sin \theta) + (a_2 \cos \theta + b_2 \sin \theta) = (a_1 + a_2) \cos \theta + (b_1 + b_2) \sin \theta$$

and

$$r \cdot (a \cos \theta + b \sin \theta) = (ra) \cos \theta + (rb) \sin \theta$$

inherited from the space in the prior example. (We can think of  $F$  as “the same” as  $\mathbb{R}^2$  in that  $a \cos \theta + b \sin \theta$  corresponds to the vector with components  $a$  and  $b$ .)

**1.14 Example** The set

$$\left\{ f: \mathbb{R} \rightarrow \mathbb{R} \mid \frac{d^2 f}{dx^2} + f = 0 \right\}$$

is a vector space under the, by now natural, interpretation.

$$(f + g)(x) = f(x) + g(x) \quad (r \cdot f)(x) = r f(x)$$

In particular, notice that closure is a consequence

$$\frac{d^2(f + g)}{dx^2} + (f + g) = \left( \frac{d^2 f}{dx^2} + f \right) + \left( \frac{d^2 g}{dx^2} + g \right)$$

and

$$\frac{d^2(rf)}{dx^2} + (rf) = r \left( \frac{d^2 f}{dx^2} + f \right)$$

of basic Calculus. This turns out to equal the space from the prior example — functions satisfying this differential equation have the form  $a \cos \theta + b \sin \theta$  — but this description suggests an extension to solutions sets of other differential equations.

**1.15 Example** The set of solutions of a homogeneous linear system in  $n$  variables is a vector space under the operations inherited from  $\mathbb{R}^n$ . For example, for closure under addition consider a typical equation in that system  $c_1 x_1 + \cdots + c_n x_n = 0$  and suppose that both these vectors

$$\vec{v} = \begin{pmatrix} v_1 \\ \vdots \\ v_n \end{pmatrix} \quad \vec{w} = \begin{pmatrix} w_1 \\ \vdots \\ w_n \end{pmatrix}$$

satisfy the equation. Then their sum  $\vec{v} + \vec{w}$  also satisfies that equation:  $c_1(v_1 + w_1) + \cdots + c_n(v_n + w_n) = (c_1 v_1 + \cdots + c_n v_n) + (c_1 w_1 + \cdots + c_n w_n) = 0$ . The checks of the other vector space conditions are just as routine.

As we’ve done in those equations, we often omit the multiplication symbol ‘ $\cdot$ ’ between the scalar and the vector. We can distinguish the multiplication in ‘ $c_1 v_1$ ’ from that in ‘ $r\vec{v}$ ’ by context, since if both multiplicands are real numbers then it must be real-real multiplication while if one is a vector then it must be scalar-vector multiplication.

Example 1.15 has brought us full circle since it is one of our motivating examples. Now, with some feel for the kinds of structures that satisfy the definition of a vector space, we can reflect on that definition. For example, why specify in the definition the condition that  $1 \cdot \vec{v} = \vec{v}$  but not a condition that  $0 \cdot \vec{v} = \vec{0}$ ?

One answer is that this is just a definition—it gives the rules of the game from here on, and if you don't like it, move on to something else.

Another answer is perhaps more satisfying. People in this area have worked hard to develop the right balance of power and generality. This definition is shaped so that it contains the conditions needed to prove all of the interesting and important properties of spaces of linear combinations. As we proceed, we shall derive all of the properties natural to collections of linear combinations from the conditions given in the definition.

The next result is an example. We do not need to include these properties in the definition of vector space because they follow from the properties already listed there.

**1.16 Lemma** In any vector space  $V$ , for any  $\vec{v} \in V$  and  $r \in \mathbb{R}$ , we have (1)  $0 \cdot \vec{v} = \vec{0}$ , and (2)  $(-1 \cdot \vec{v}) + \vec{v} = \vec{0}$ , and (3)  $r \cdot \vec{0} = \vec{0}$ .

**PROOF** For (1), note that  $\vec{v} = (1 + 0) \cdot \vec{v} = \vec{v} + (0 \cdot \vec{v})$ . Add to both sides the additive inverse of  $\vec{v}$ , the vector  $\vec{w}$  such that  $\vec{w} + \vec{v} = \vec{0}$ .

$$\begin{aligned}\vec{w} + \vec{v} &= \vec{w} + \vec{v} + 0 \cdot \vec{v} \\ \vec{0} &= \vec{0} + 0 \cdot \vec{v} \\ \vec{0} &= 0 \cdot \vec{v}\end{aligned}$$

Item (2) is easy:  $(-1 \cdot \vec{v}) + \vec{v} = (-1 + 1) \cdot \vec{v} = 0 \cdot \vec{v} = \vec{0}$  shows that we can write ' $-\vec{v}$ ' for the additive inverse of  $\vec{v}$  without worrying about possible confusion with  $(-1) \cdot \vec{v}$ .

For (3), this  $r \cdot \vec{0} = r \cdot (0 \cdot \vec{0}) = (r \cdot 0) \cdot \vec{0} = \vec{0}$  will do. QED

We finish with a recap. Our study in Chapter One of Gaussian reduction led us to consider collections of linear combinations. So in this chapter we have defined a vector space to be a structure in which we can form such combinations, expressions of the form  $c_1 \cdot \vec{v}_1 + \cdots + c_n \cdot \vec{v}_n$  (subject to simple conditions on the addition and scalar multiplication operations). In a phrase: vector spaces are the right context in which to study linearity.

Finally, a comment. From the fact that it forms a whole chapter, and especially because that chapter is the first one, a reader could suppose that our purpose is the study of linear systems. The truth is, we will not so much use vector spaces in the study of linear systems as we will instead have linear systems start us on the study of vector spaces. The wide variety of examples from this subsection shows that the study of vector spaces is interesting and important in its own right, aside from how it helps us understand linear systems.

Linear systems won't go away. But from now on our primary objects of study will be vector spaces.

### Exercises

1.17 Name the zero vector for each of these vector spaces.

- (a) The space of degree three polynomials under the natural operations
- (b) The space of  $2 \times 4$  matrices
- (c) The space  $\{f: [0..1] \rightarrow \mathbb{R} \mid f \text{ is continuous}\}$
- (d) The space of real-valued functions of one natural number variable

✓ 1.18 Find the additive inverse, in the vector space, of the vector.

- (a) In  $\mathcal{P}_3$ , the vector  $-3 - 2x + x^2$ .
- (b) In the space  $2 \times 2$ ,

$$\begin{pmatrix} 1 & -1 \\ 0 & 3 \end{pmatrix}.$$

- (c) In  $\{ae^x + be^{-x} \mid a, b \in \mathbb{R}\}$ , the space of functions of the real variable  $x$  under the natural operations, the vector  $3e^x - 2e^{-x}$ .

✓ 1.19 Show that each of these is a vector space.

- (a) The set of linear polynomials  $\mathcal{P}_1 = \{a_0 + a_1x \mid a_0, a_1 \in \mathbb{R}\}$  under the usual polynomial addition and scalar multiplication operations.
- (b) The set of  $2 \times 2$  matrices with real entries under the usual matrix operations.
- (c) The set of three-component row vectors with their usual operations.
- (d) The set

$$L = \left\{ \begin{pmatrix} x \\ y \\ z \\ w \end{pmatrix} \in \mathbb{R}^4 \mid x + y - z + w = 0 \right\}$$

under the operations inherited from  $\mathbb{R}^4$ .

✓ 1.20 Show that each of these is not a vector space. (*Hint.* Check closure by listing two members of each set and trying some operations on them.)

- (a) Under the operations inherited from  $\mathbb{R}^3$ , this set

$$\left\{ \begin{pmatrix} x \\ y \\ z \end{pmatrix} \in \mathbb{R}^3 \mid x + y + z = 1 \right\}$$

- (b) Under the operations inherited from  $\mathbb{R}^3$ , this set

$$\left\{ \begin{pmatrix} x \\ y \\ z \end{pmatrix} \in \mathbb{R}^3 \mid x^2 + y^2 + z^2 = 1 \right\}$$

- (c) Under the usual matrix operations,

$$\left\{ \begin{pmatrix} a & 1 \\ b & c \end{pmatrix} \mid a, b, c \in \mathbb{R} \right\}$$

- (d) Under the usual polynomial operations,

$$\{a_0 + a_1x + a_2x^2 \mid a_0, a_1, a_2 \in \mathbb{R}^+\}$$

where  $\mathbb{R}^+$  is the set of reals greater than zero

- (e) Under the inherited operations,

$$\left\{ \begin{pmatrix} x \\ y \end{pmatrix} \in \mathbb{R}^2 \mid x + 3y = 4 \text{ and } 2x - y = 3 \text{ and } 6x + 4y = 10 \right\}$$

1.21 Define addition and scalar multiplication operations to make the complex numbers a vector space over  $\mathbb{R}$ .

✓ 1.22 Is the set of rational numbers a vector space over  $\mathbb{R}$  under the usual addition and scalar multiplication operations?

1.23 Show that the set of linear combinations of the variables  $x, y, z$  is a vector space under the natural addition and scalar multiplication operations.

1.24 Prove that this is not a vector space: the set of two-tall column vectors with real entries subject to these operations.

$$\begin{pmatrix} x_1 \\ y_1 \end{pmatrix} + \begin{pmatrix} x_2 \\ y_2 \end{pmatrix} = \begin{pmatrix} x_1 - x_2 \\ y_1 - y_2 \end{pmatrix} \quad r \cdot \begin{pmatrix} x \\ y \end{pmatrix} = \begin{pmatrix} rx \\ ry \end{pmatrix}$$

1.25 Prove or disprove that  $\mathbb{R}^3$  is a vector space under these operations.

(a)  $\begin{pmatrix} x_1 \\ y_1 \\ z_1 \end{pmatrix} + \begin{pmatrix} x_2 \\ y_2 \\ z_2 \end{pmatrix} = \begin{pmatrix} 0 \\ 0 \\ 0 \end{pmatrix}$  and  $r \begin{pmatrix} x \\ y \\ z \end{pmatrix} = \begin{pmatrix} rx \\ ry \\ rz \end{pmatrix}$

(b)  $\begin{pmatrix} x_1 \\ y_1 \\ z_1 \end{pmatrix} + \begin{pmatrix} x_2 \\ y_2 \\ z_2 \end{pmatrix} = \begin{pmatrix} 0 \\ 0 \\ 0 \end{pmatrix}$  and  $r \begin{pmatrix} x \\ y \\ z \end{pmatrix} = \begin{pmatrix} 0 \\ 0 \\ 0 \end{pmatrix}$

✓ 1.26 For each, decide if it is a vector space; the intended operations are the natural ones.

(a) The *diagonal*  $2 \times 2$  matrices

$$\left\{ \begin{pmatrix} a & 0 \\ 0 & b \end{pmatrix} \mid a, b \in \mathbb{R} \right\}$$

(b) This set of  $2 \times 2$  matrices

$$\left\{ \begin{pmatrix} x & x+y \\ x+y & y \end{pmatrix} \mid x, y \in \mathbb{R} \right\}$$

(c) This set

$$\left\{ \begin{pmatrix} x \\ y \\ z \\ w \end{pmatrix} \in \mathbb{R}^4 \mid x + y + w = 1 \right\}$$

(d) The set of functions  $\{f: \mathbb{R} \rightarrow \mathbb{R} \mid df/dx + 2f = 0\}$

(e) The set of functions  $\{f: \mathbb{R} \rightarrow \mathbb{R} \mid df/dx + 2f = 1\}$

✓ 1.27 Prove or disprove that this is a vector space: the real-valued functions  $f$  of one real variable such that  $f(7) = 0$ .

✓ 1.28 Show that the set  $\mathbb{R}^+$  of positive reals is a vector space when we interpret ‘ $x+y$ ’ to mean the product of  $x$  and  $y$  (so that  $2+3$  is 6), and we interpret ‘ $r \cdot x$ ’ as the  $r$ -th power of  $x$ .

1.29 Is  $\{(x, y) \mid x, y \in \mathbb{R}\}$  a vector space under these operations?

(a)  $(x_1, y_1) + (x_2, y_2) = (x_1 + x_2, y_1 + y_2)$  and  $r \cdot (x, y) = (rx, y)$

(b)  $(x_1, y_1) + (x_2, y_2) = (x_1 + x_2, y_1 + y_2)$  and  $r \cdot (x, y) = (rx, 0)$

1.30 Prove or disprove that this is a vector space: the set of polynomials of degree greater than or equal to two, along with the zero polynomial.

1.31 At this point “the same” is only an intuition, but nonetheless for each vector space identify the  $k$  for which the space is “the same” as  $\mathbb{R}^k$ .

(a) The  $2 \times 3$  matrices under the usual operations

(b) The  $n \times m$  matrices (under their usual operations)

(c) This set of  $2 \times 2$  matrices

$$\left\{ \begin{pmatrix} a & 0 \\ b & c \end{pmatrix} \mid a, b, c \in \mathbb{R} \right\}$$

(d) This set of  $2 \times 2$  matrices

$$\left\{ \begin{pmatrix} a & 0 \\ b & c \end{pmatrix} \mid a + b + c = 0 \right\}$$

✓ 1.32 Using  $\vec{+}$  to represent vector addition and  $\vec{\cdot}$  for scalar multiplication, restate the definition of vector space.

✓ 1.33 Prove these.

(a) Any vector is the additive inverse of the additive inverse of itself.

(b) Vector addition left-cancels: if  $\vec{v}, \vec{s}, \vec{t} \in V$  then  $\vec{v} + \vec{s} = \vec{v} + \vec{t}$  implies that  $\vec{s} = \vec{t}$ .

1.34 The definition of vector spaces does not explicitly say that  $\vec{0} + \vec{v} = \vec{v}$  (it instead says that  $\vec{v} + \vec{0} = \vec{v}$ ). Show that it must nonetheless hold in any vector space.

✓ 1.35 Prove or disprove that this is a vector space: the set of all matrices, under the usual operations.

1.36 In a vector space every element has an additive inverse. Can some elements have two or more?

1.37 (a) Prove that every point, line, or plane thru the origin in  $\mathbb{R}^3$  is a vector space under the inherited operations.

(b) What if it doesn't contain the origin?

✓ 1.38 Using the idea of a vector space we can easily reprove that the solution set of a homogeneous linear system has either one element or infinitely many elements. Assume that  $\vec{v} \in V$  is not  $\vec{0}$ .

(a) Prove that  $r \cdot \vec{v} = \vec{0}$  if and only if  $r = 0$ .

(b) Prove that  $r_1 \cdot \vec{v} = r_2 \cdot \vec{v}$  if and only if  $r_1 = r_2$ .

(c) Prove that any nontrivial vector space is infinite.

(d) Use the fact that a nonempty solution set of a homogeneous linear system is a vector space to draw the conclusion.

1.39 Is this a vector space under the natural operations: the real-valued functions of one real variable that are differentiable?

1.40 A *vector space over the complex numbers*  $\mathbb{C}$  has the same definition as a vector space over the reals except that scalars are drawn from  $\mathbb{C}$  instead of from  $\mathbb{R}$ . Show that each of these is a vector space over the complex numbers. (Recall how complex numbers add and multiply:  $(a_0 + a_1 i) + (b_0 + b_1 i) = (a_0 + b_0) + (a_1 + b_1) i$  and  $(a_0 + a_1 i)(b_0 + b_1 i) = (a_0 b_0 - a_1 b_1) + (a_0 b_1 + a_1 b_0) i$ .)

(a) The set of degree two polynomials with complex coefficients

(b) This set

$$\left\{ \begin{pmatrix} 0 & a \\ b & 0 \end{pmatrix} \mid a, b \in \mathbb{C} \text{ and } a + b = 0 + 0i \right\}$$

1.41 Name a property shared by all of the  $\mathbb{R}^n$ 's but not listed as a requirement for a vector space.

✓ 1.42 (a) Prove that for any four vectors  $\vec{v}_1, \dots, \vec{v}_4 \in V$  we can associate their sum in any way without changing the result.

$$\begin{aligned} ((\vec{v}_1 + \vec{v}_2) + \vec{v}_3) + \vec{v}_4 &= (\vec{v}_1 + (\vec{v}_2 + \vec{v}_3)) + \vec{v}_4 = (\vec{v}_1 + \vec{v}_2) + (\vec{v}_3 + \vec{v}_4) \\ &= \vec{v}_1 + ((\vec{v}_2 + \vec{v}_3) + \vec{v}_4) = \vec{v}_1 + (\vec{v}_2 + (\vec{v}_3 + \vec{v}_4)) \end{aligned}$$

This allows us to write ' $\vec{v}_1 + \vec{v}_2 + \vec{v}_3 + \vec{v}_4$ ' without ambiguity.

(b) Prove that any two ways of associating a sum of any number of vectors give the same sum. (*Hint.* Use induction on the number of vectors.)

1.43 Example 1.5 gives a subset of  $\mathbb{R}^2$  that is not a vector space, under the obvious operations, because while it is closed under addition, it is not closed under scalar multiplication. Consider the set of vectors in the plane whose components have the same sign or are 0. Show that this set is closed under scalar multiplication but not addition.

1.44 For any vector space, a subset that is itself a vector space under the inherited operations (e.g., a plane through the origin inside of  $\mathbb{R}^3$ ) is a *subspace*.

(a) Show that  $\{a_0 + a_1x + a_2x^2 \mid a_0 + a_1 + a_2 = 0\}$  is a subspace of the vector space of degree two polynomials.

(b) Show that this is a subspace of the  $2 \times 2$  matrices.

$$\left\{ \begin{pmatrix} a & b \\ c & 0 \end{pmatrix} \mid a + b = 0 \right\}$$

(c) Show that a nonempty subset  $S$  of a real vector space is a subspace if and only if it is closed under linear combinations of pairs of vectors: whenever  $c_1, c_2 \in \mathbb{R}$  and  $\vec{s}_1, \vec{s}_2 \in S$  then the combination  $c_1\vec{s}_1 + c_2\vec{s}_2$  is in  $S$ .

## I.2 Subspaces and Spanning Sets

One of the examples that led us to introduce the idea of a vector space was the solution set of a homogeneous system. For instance, we've seen in Example 1.4 such a space that is a planar subset of  $\mathbb{R}^3$ . There, the vector space  $\mathbb{R}^3$  contains inside it another vector space, the plane.

**2.1 Definition** For any vector space, a *subspace* is a subset that is itself a vector space, under the inherited operations.

**2.2 Example** The plane from the prior subsection,

$$P = \left\{ \begin{pmatrix} x \\ y \\ z \end{pmatrix} \mid x + y + z = 0 \right\}$$

is a subspace of  $\mathbb{R}^3$ . As specified in the definition, the operations are the ones that are inherited from the larger space, that is, vectors add in  $P$  as they add in  $\mathbb{R}^3$

$$\begin{pmatrix} x_1 \\ y_1 \\ z_1 \end{pmatrix} + \begin{pmatrix} x_2 \\ y_2 \\ z_2 \end{pmatrix} = \begin{pmatrix} x_1 + x_2 \\ y_1 + y_2 \\ z_1 + z_2 \end{pmatrix}$$

and scalar multiplication is also the same as it is in  $\mathbb{R}^3$ . To show that  $P$  is a subspace, we need only note that it is a subset and then verify that it is a space. Checking that  $P$  satisfies the conditions in the definition of a vector space is routine. For instance, for closure under addition, note that if the summands

satisfy that  $x_1 + y_1 + z_1 = 0$  and  $x_2 + y_2 + z_2 = 0$  then the sum satisfies that  $(x_1 + x_2) + (y_1 + y_2) + (z_1 + z_2) = (x_1 + y_1 + z_1) + (x_2 + y_2 + z_2) = 0$ .

**2.3 Example** The  $x$ -axis in  $\mathbb{R}^2$  is a subspace where the addition and scalar multiplication operations are the inherited ones.

$$\begin{pmatrix} x_1 \\ 0 \end{pmatrix} + \begin{pmatrix} x_2 \\ 0 \end{pmatrix} = \begin{pmatrix} x_1 + x_2 \\ 0 \end{pmatrix} \quad r \cdot \begin{pmatrix} x \\ 0 \end{pmatrix} = \begin{pmatrix} rx \\ 0 \end{pmatrix}$$

As above, to verify that this is a subspace we simply note that it is a subset and then check that it satisfies the conditions in definition of a vector space. For instance, the two closure conditions are satisfied: (1) adding two vectors with a second component of zero results in a vector with a second component of zero, and (2) multiplying a scalar times a vector with a second component of zero results in a vector with a second component of zero.

**2.4 Example** Another subspace of  $\mathbb{R}^2$  is its trivial subspace.

$$\left\{ \begin{pmatrix} 0 \\ 0 \end{pmatrix} \right\}$$

Any vector space has a trivial subspace  $\{\vec{0}\}$ . At the opposite extreme, any vector space has itself for a subspace. These two are the *improper* subspaces. Other subspaces are *proper*.

**2.5 Example** The definition requires that the addition and scalar multiplication operations must be the ones inherited from the larger space. The set  $S = \{1\}$  is a subset of  $\mathbb{R}^1$ . And, under the operations  $1 + 1 = 1$  and  $r \cdot 1 = 1$  the set  $S$  is a vector space, specifically, a trivial space. However,  $S$  is not a subspace of  $\mathbb{R}^1$  because those aren't the inherited operations, since of course  $\mathbb{R}^1$  has  $1 + 1 = 2$ .

**2.6 Example** All kinds of vector spaces, not just  $\mathbb{R}^n$ 's, have subspaces. The vector space of cubic polynomials  $\{a + bx + cx^2 + dx^3 \mid a, b, c, d \in \mathbb{R}\}$  has a subspace comprised of all linear polynomials  $\{m + nx \mid m, n \in \mathbb{R}\}$ .

**2.7 Example** Another example of a subspace not taken from an  $\mathbb{R}^n$  is one from the examples following the definition of a vector space. The space of all real-valued functions of one real variable  $f: \mathbb{R} \rightarrow \mathbb{R}$  has a subspace of functions satisfying the restriction  $(d^2 f/dx^2) + f = 0$ .

**2.8 Example** Being vector spaces themselves, subspaces must satisfy the closure conditions. The set  $\mathbb{R}^+$  is not a subspace of the vector space  $\mathbb{R}^1$  because with the inherited operations it is not closed under scalar multiplication: if  $\vec{v} = 1$  then  $-1 \cdot \vec{v} \notin \mathbb{R}^+$ .

The next result says that Example 2.8 is prototypical. The only way that a subset can fail to be a subspace, if it is nonempty and under the inherited operations, is if it isn't closed.



**2.9 Lemma** For a nonempty subset  $S$  of a vector space, under the inherited operations, the following are equivalent statements.\*

- (1)  $S$  is a subspace of that vector space
- (2)  $S$  is closed under linear combinations of pairs of vectors: for any vectors  $\vec{s}_1, \vec{s}_2 \in S$  and scalars  $r_1, r_2$  the vector  $r_1\vec{s}_1 + r_2\vec{s}_2$  is in  $S$
- (3)  $S$  is closed under linear combinations of any number of vectors: for any vectors  $\vec{s}_1, \dots, \vec{s}_n \in S$  and scalars  $r_1, \dots, r_n$  the vector  $r_1\vec{s}_1 + \dots + r_n\vec{s}_n$  is in  $S$ .

Briefly, a subset is a subspace if it is closed under linear combinations.

PROOF ‘The following are equivalent’ means that each pair of statements are equivalent.

$$(1) \iff (2) \quad (2) \iff (3) \quad (3) \iff (1)$$

We will show these statements are equivalent by establishing that (1)  $\implies$  (3)  $\implies$  (2)  $\implies$  (1). This strategy is suggested by the observation that (1)  $\implies$  (3) and (3)  $\implies$  (2) are easy and so we need only argue the single implication (2)  $\implies$  (1).

Assume that  $S$  is a nonempty subset of a vector space  $V$  that is  $S$  closed under combinations of pairs of vectors. We will show that  $S$  is a vector space by checking the conditions.

The first item in the vector space definition has five conditions. First, for closure under addition, if  $\vec{s}_1, \vec{s}_2 \in S$  then  $\vec{s}_1 + \vec{s}_2 \in S$ , as  $\vec{s}_1 + \vec{s}_2 = 1 \cdot \vec{s}_1 + 1 \cdot \vec{s}_2$ . Second, for any  $\vec{s}_1, \vec{s}_2 \in S$ , because addition is inherited from  $V$ , the sum  $\vec{s}_1 + \vec{s}_2$  in  $S$  equals the sum  $\vec{s}_1 + \vec{s}_2$  in  $V$ , and that equals the sum  $\vec{s}_2 + \vec{s}_1$  in  $V$  (because  $V$  is a vector space, its addition is commutative), and that in turn equals the sum  $\vec{s}_2 + \vec{s}_1$  in  $S$ . The argument for the third condition is similar to that for the second. For the fourth, consider the zero vector of  $V$  and note that closure of  $S$  under linear combinations of pairs of vectors gives that (where  $\vec{s}$  is any member of the nonempty set  $S$ )  $0 \cdot \vec{s} + 0 \cdot \vec{s} = \vec{0}$  is in  $S$ ; showing that  $\vec{0}$  acts under the inherited operations as the additive identity of  $S$  is easy. The fifth condition is satisfied because for any  $\vec{s} \in S$ , closure under linear combinations shows that the vector  $0 \cdot \vec{0} + (-1) \cdot \vec{s}$  is in  $S$ ; showing that it is the additive inverse of  $\vec{s}$  under the inherited operations is routine.

The checks for item (2) are similar and are Exercise 33. QED

We usually show that a subset is a subspace with (2)  $\implies$  (1).

**2.10 Remark** At the start of this chapter we introduced vector spaces as collections in which linear combinations are “sensible.” The above result speaks to this.

The vector space definition has ten conditions but eight of them, the conditions not about closure, simply ensure that referring to the operations as an ‘addition’ and a ‘scalar multiplication’ is sensible. The proof above checks that these eight are inherited from the surrounding vector space provided that the nonempty set  $S$  satisfies Theorem 2.9’s statement (2) (e.g., commutativity of

addition in  $S$  follows right from commutativity of addition in  $V$ ). So, in this context, this meaning of “sensible” is automatically satisfied.

In assuring us that this first meaning of the word is met, the result draws our attention to the second meaning of “sensible.” It has to do with the two remaining conditions, the closure conditions. Above, the two separate closure conditions inherent in statement (1) combine in statement (2) into the single condition of closure under all linear combinations of two vectors, which then extends in statement (3) to closure under combinations of any number of vectors. The latter two statements say that we can always make sense of an expression like  $r_1 \vec{s}_1 + r_2 \vec{s}_2$ , without restrictions on the  $r$ 's—such expressions are “sensible” in that the vector described is defined and is in the set  $S$ .

This second meaning suggests that a good way to think of a vector space is as a collection of unrestricted linear combinations. The next two examples take some spaces and describe them in this way. In these examples we parametrize, just as we did in Chapter One to describe the solution set of a homogeneous linear system.

**2.11 Example** This subset of  $\mathbb{R}^3$

$$S = \left\{ \begin{pmatrix} x \\ y \\ z \end{pmatrix} \mid x - 2y + z = 0 \right\}$$

is a subspace under the usual addition and scalar multiplication operations of column vectors (the check that it is nonempty and closed under linear combinations of two vectors is just like the one in Example 2.2). To parametrize, we can take  $x - 2y + z = 0$  to be a one-equation linear system and expressing the leading variable in terms of the free variables  $x = 2y - z$ .

$$S = \left\{ \begin{pmatrix} 2y - z \\ y \\ z \end{pmatrix} \mid y, z \in \mathbb{R} \right\} = \left\{ y \begin{pmatrix} 2 \\ 1 \\ 0 \end{pmatrix} + z \begin{pmatrix} -1 \\ 0 \\ 1 \end{pmatrix} \mid y, z \in \mathbb{R} \right\}$$

We have described the subspace as the collection of unrestricted linear combinations of those two vectors. Of course, in either description, this is a plane through the origin.

**2.12 Example** This is a subspace of the  $2 \times 2$  matrices

$$L = \left\{ \begin{pmatrix} a & 0 \\ b & c \end{pmatrix} \mid a + b + c = 0 \right\}$$

(checking that it is nonempty and closed under linear combinations is easy). To parametrize, express the condition as  $a = -b - c$ .

$$L = \left\{ \begin{pmatrix} -b - c & 0 \\ b & c \end{pmatrix} \mid b, c \in \mathbb{R} \right\} = \left\{ b \begin{pmatrix} -1 & 0 \\ 1 & 0 \end{pmatrix} + c \begin{pmatrix} -1 & 0 \\ 0 & 1 \end{pmatrix} \mid b, c \in \mathbb{R} \right\}$$

As above, we've described the subspace as a collection of unrestricted linear combinations.

Parametrization is easy, but important. We shall use it often.

**2.13 Definition** The *span* (or *linear closure*) of a nonempty subset  $S$  of a vector space is the set of all linear combinations of vectors from  $S$ .

$$[S] = \{c_1 \vec{s}_1 + \cdots + c_n \vec{s}_n \mid c_1, \dots, c_n \in \mathbb{R} \text{ and } \vec{s}_1, \dots, \vec{s}_n \in S\}$$

The span of the empty subset of a vector space is the trivial subspace.

No notation for the span is completely standard. The square brackets used here are common but so are ‘span( $S$ )’ and ‘sp( $S$ )’.

**2.14 Remark** In Chapter One, after we showed that we can write the solution set of a homogeneous linear system as  $\{c_1 \vec{\beta}_1 + \cdots + c_k \vec{\beta}_k \mid c_1, \dots, c_k \in \mathbb{R}\}$ , we described that as the set ‘generated’ by the  $\vec{\beta}$ ’s. We now call that the span of  $\{\vec{\beta}_1, \dots, \vec{\beta}_k\}$ .

Recall also the discussion of the “tricky point” in that proof. The span of the empty set is defined to be the set  $\{\vec{0}\}$  because we follow the convention that a linear combination of no vectors sums to  $\vec{0}$ . Besides, defining the empty set’s span to be the trivial subspace is convenient in that it keeps results like the next one from needing exceptions for the empty set.

**2.15 Lemma** In a vector space, the span of any subset is a subspace.

**PROOF** If the subset  $S$  is empty then by definition its span is the trivial subspace. If  $S$  is not empty then by Lemma 2.9 we need only check that the span  $[S]$  is closed under linear combinations. For a pair of vectors from that span,  $\vec{v} = c_1 \vec{s}_1 + \cdots + c_n \vec{s}_n$  and  $\vec{w} = c_{n+1} \vec{s}_{n+1} + \cdots + c_m \vec{s}_m$ , a linear combination

$$\begin{aligned} p \cdot (c_1 \vec{s}_1 + \cdots + c_n \vec{s}_n) + r \cdot (c_{n+1} \vec{s}_{n+1} + \cdots + c_m \vec{s}_m) \\ = pc_1 \vec{s}_1 + \cdots + pc_n \vec{s}_n + rc_{n+1} \vec{s}_{n+1} + \cdots + rc_m \vec{s}_m \end{aligned}$$

( $p, r$  scalars) is a linear combination of elements of  $S$  and so is in  $[S]$  (possibly some of the  $\vec{s}_i$ ’s from  $\vec{v}$  equal some of the  $\vec{s}_j$ ’s from  $\vec{w}$ , but it does not matter). QED

The converse of the lemma holds: any subspace is the span of some set, because a subspace is obviously the span of the set of its members. Thus a subset of a vector space is a subspace if and only if it is a span. This fits the intuition that a good way to think of a vector space is as a collection in which linear combinations are sensible.

Taken together, Lemma 2.9 and Lemma 2.15 show that the span of a subset  $S$  of a vector space is the smallest subspace containing all the members of  $S$ .

**2.16 Example** In any vector space  $V$ , for any vector  $\vec{v}$  the set  $\{r \cdot \vec{v} \mid r \in \mathbb{R}\}$  is a subspace of  $V$ . For instance, for any vector  $\vec{v} \in \mathbb{R}^3$  the line through the origin containing that vector  $\{k\vec{v} \mid k \in \mathbb{R}\}$  is a subspace of  $\mathbb{R}^3$ . This is true even when  $\vec{v}$  is the zero vector, in which case the subspace is the degenerate line, the trivial subspace.

**2.17 Example** The span of this set is all of  $\mathbb{R}^2$ .

$$\left\{ \begin{pmatrix} 1 \\ 1 \end{pmatrix}, \begin{pmatrix} 1 \\ -1 \end{pmatrix} \right\}$$

To check this we must show that any member of  $\mathbb{R}^2$  is a linear combination of these two vectors. So we ask: for which vectors (with real components  $x$  and  $y$ ) are there scalars  $c_1$  and  $c_2$  such that this holds?

$$c_1 \begin{pmatrix} 1 \\ 1 \end{pmatrix} + c_2 \begin{pmatrix} 1 \\ -1 \end{pmatrix} = \begin{pmatrix} x \\ y \end{pmatrix}$$

Gauss' method

$$\begin{array}{rcl} c_1 + c_2 = x & \xrightarrow{-\rho_1 + \rho_2} & c_1 + c_2 = x \\ c_1 - c_2 = y & & -2c_2 = -x + y \end{array}$$

with back substitution gives  $c_2 = (x - y)/2$  and  $c_1 = (x + y)/2$ . These two equations show that for any  $x$  and  $y$  there are appropriate coefficients  $c_1$  and  $c_2$  making the above vector equation true. For instance, for  $x = 1$  and  $y = 2$  the coefficients  $c_2 = -1/2$  and  $c_1 = 3/2$  will do. That is, we can write any vector in  $\mathbb{R}^2$  as a linear combination of the two given vectors.

Since spans are subspaces, and we know that a good way to understand a subspace is to parametrize its description, we can try to understand a set's span in that way.

**2.18 Example** Consider, in  $\mathcal{P}_2$ , the span of the set  $\{3x - x^2, 2x\}$ . By the definition of span, it is the set of unrestricted linear combinations of the two  $\{c_1(3x - x^2) + c_2(2x) \mid c_1, c_2 \in \mathbb{R}\}$ . Clearly polynomials in this span must have a constant term of zero. Is that necessary condition also sufficient?

We are asking: for which members  $a_2x^2 + a_1x + a_0$  of  $\mathcal{P}_2$  are there  $c_1$  and  $c_2$  such that  $a_2x^2 + a_1x + a_0 = c_1(3x - x^2) + c_2(2x)$ ? Since polynomials are equal if and only if their coefficients are equal, we are looking for conditions on  $a_2$ ,  $a_1$ , and  $a_0$  satisfying these.

$$\begin{array}{rcl} -c_1 & = & a_2 \\ 3c_1 + 2c_2 & = & a_1 \\ 0 & = & a_0 \end{array}$$

Gauss' method gives that  $c_1 = -a_2$ ,  $c_2 = (3/2)a_2 + (1/2)a_1$ , and  $0 = a_0$ . Thus the only condition on polynomials in the span is the condition that we knew of— as long as  $a_0 = 0$ , we can give appropriate coefficients  $c_1$  and  $c_2$  to describe the polynomial  $a_0 + a_1x + a_2x^2$  as in the span. For instance, for the polynomial  $0 - 4x + 3x^2$ , the coefficients  $c_1 = -3$  and  $c_2 = 5/2$  will do. So the span of the given set is  $\{a_1x + a_2x^2 \mid a_1, a_2 \in \mathbb{R}\}$ .

This shows, incidentally, that the set  $\{x, x^2\}$  also spans this subspace. A space can have more than one spanning set. Two other sets spanning this subspace are  $\{x, x^2, -x + 2x^2\}$  and  $\{x, x + x^2, x + 2x^2, \dots\}$ . (Naturally, we usually prefer to work with spanning sets that have only a few members.)

**2.19 Example** These are the subspaces of  $\mathbb{R}^3$  that we now know of, the trivial subspace, the lines through the origin, the planes through the origin, and the whole space (of course, the picture shows only a few of the infinitely many subspaces). In the next section we will prove that  $\mathbb{R}^3$  has no other type of subspaces, so in fact this picture shows them all.

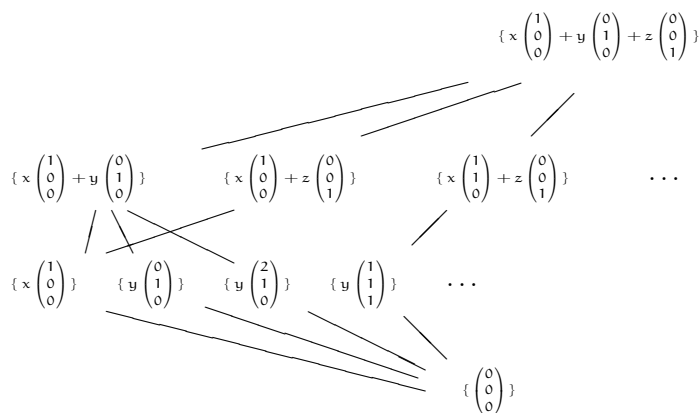

We have described the subspaces as spans of sets with a minimal number of members and shown them connected to their supersets. Note that the subspaces fall naturally into levels—planes on one level, lines on another, etc.—according to how many vectors are in a minimal-sized spanning set.

So far in this chapter we have seen that to study the properties of linear combinations, the right setting is a collection that is closed under these combinations. In the first subsection we introduced such collections, vector spaces, and we saw a great variety of examples. In this subsection we saw still more spaces, ones that happen to be subspaces of others. In all of the variety we've seen a commonality. Example 2.19 above brings it out: vector spaces and subspaces are best understood as a span, and especially as a span of a small number of vectors. The next section studies spanning sets that are minimal.

### Exercises

✓ **2.20** Which of these subsets of the vector space of  $2 \times 2$  matrices are subspaces under the inherited operations? For each one that is a subspace, parametrize its description. For each that is not, give a condition that fails.

- (a)  $\{ \begin{pmatrix} a & 0 \\ 0 & b \end{pmatrix} \mid a, b \in \mathbb{R} \}$
- (b)  $\{ \begin{pmatrix} a & 0 \\ 0 & b \end{pmatrix} \mid a + b = 0 \}$
- (c)  $\{ \begin{pmatrix} a & 0 \\ 0 & b \end{pmatrix} \mid a + b = 5 \}$
- (d)  $\{ \begin{pmatrix} a & c \\ 0 & b \end{pmatrix} \mid a + b = 0, c \in \mathbb{R} \}$

✓ **2.21** Is this a subspace of  $\mathcal{P}_2$ :  $\{a_0 + a_1x + a_2x^2 \mid a_0 + 2a_1 + a_2 = 4\}$ ? If it is then parametrize its description.

- ✓ 2.22 Decide if the vector lies in the span of the set, inside of the space.
- (a)  $\begin{pmatrix} 2 \\ 0 \\ 1 \end{pmatrix}$ ,  $\left\{ \begin{pmatrix} 1 \\ 0 \\ 0 \end{pmatrix}, \begin{pmatrix} 0 \\ 0 \\ 1 \end{pmatrix} \right\}$ , in  $\mathbb{R}^3$
- (b)  $x - x^3$ ,  $\{x^2, 2x + x^2, x + x^3\}$ , in  $\mathcal{P}_3$
- (c)  $\begin{pmatrix} 0 & 1 \\ 4 & 2 \end{pmatrix}$ ,  $\left\{ \begin{pmatrix} 1 & 0 \\ 1 & 1 \end{pmatrix}, \begin{pmatrix} 2 & 0 \\ 2 & 3 \end{pmatrix} \right\}$ , in  $\mathcal{M}_{2 \times 2}$
- 2.23 Which of these are members of the span  $[\{\cos^2 x, \sin^2 x\}]$  in the vector space of real-valued functions of one real variable?
- (a)  $f(x) = 1$    (b)  $f(x) = 3 + x^2$    (c)  $f(x) = \sin x$    (d)  $f(x) = \cos(2x)$
- ✓ 2.24 Which of these sets spans  $\mathbb{R}^3$ ? That is, which of these sets has the property that any three-tall vector can be expressed as a suitable linear combination of the set's elements?
- (a)  $\left\{ \begin{pmatrix} 1 \\ 0 \\ 0 \end{pmatrix}, \begin{pmatrix} 0 \\ 2 \\ 0 \end{pmatrix}, \begin{pmatrix} 0 \\ 0 \\ 3 \end{pmatrix} \right\}$    (b)  $\left\{ \begin{pmatrix} 2 \\ 0 \\ 1 \end{pmatrix}, \begin{pmatrix} 1 \\ 1 \\ 0 \end{pmatrix}, \begin{pmatrix} 0 \\ 0 \\ 1 \end{pmatrix} \right\}$    (c)  $\left\{ \begin{pmatrix} 1 \\ 1 \\ 0 \end{pmatrix}, \begin{pmatrix} 3 \\ 0 \\ 0 \end{pmatrix} \right\}$
- (d)  $\left\{ \begin{pmatrix} 1 \\ 0 \\ 1 \end{pmatrix}, \begin{pmatrix} 3 \\ 1 \\ 0 \end{pmatrix}, \begin{pmatrix} -1 \\ 0 \\ 0 \end{pmatrix}, \begin{pmatrix} 2 \\ 1 \\ 5 \end{pmatrix} \right\}$    (e)  $\left\{ \begin{pmatrix} 2 \\ 1 \\ 1 \end{pmatrix}, \begin{pmatrix} 3 \\ 0 \\ 1 \end{pmatrix}, \begin{pmatrix} 5 \\ 1 \\ 2 \end{pmatrix}, \begin{pmatrix} 6 \\ 0 \\ 2 \end{pmatrix} \right\}$
- ✓ 2.25 Parametrize each subspace's description. Then express each subspace as a span.
- (a) The subset  $\{(a \ b \ c) \mid a - c = 0\}$  of the three-wide row vectors
- (b) This subset of  $\mathcal{M}_{2 \times 2}$
- $$\left\{ \begin{pmatrix} a & b \\ c & d \end{pmatrix} \mid a + d = 0 \right\}$$
- (c) This subset of  $\mathcal{M}_{2 \times 2}$
- $$\left\{ \begin{pmatrix} a & b \\ c & d \end{pmatrix} \mid 2a - c - d = 0 \text{ and } a + 3b = 0 \right\}$$
- (d) The subset  $\{a + bx + cx^3 \mid a - 2b + c = 0\}$  of  $\mathcal{P}_3$
- (e) The subset of  $\mathcal{P}_2$  of quadratic polynomials  $p$  such that  $p(7) = 0$
- ✓ 2.26 Find a set to span the given subspace of the given space. (*Hint.* Parametrize each.)
- (a) the  $xz$ -plane in  $\mathbb{R}^3$
- (b)  $\left\{ \begin{pmatrix} x \\ y \\ z \end{pmatrix} \mid 3x + 2y + z = 0 \right\}$  in  $\mathbb{R}^3$
- (c)  $\left\{ \begin{pmatrix} x \\ y \\ z \\ w \end{pmatrix} \mid 2x + y + w = 0 \text{ and } y + 2z = 0 \right\}$  in  $\mathbb{R}^4$
- (d)  $\{a_0 + a_1x + a_2x^2 + a_3x^3 \mid a_0 + a_1 = 0 \text{ and } a_2 - a_3 = 0\}$  in  $\mathcal{P}_3$
- (e) The set  $\mathcal{P}_4$  in the space  $\mathcal{P}_4$
- (f)  $\mathcal{M}_{2 \times 2}$  in  $\mathcal{M}_{2 \times 2}$
- 2.27 Is  $\mathbb{R}^2$  a subspace of  $\mathbb{R}^3$ ?
- ✓ 2.28 Decide if each is a subspace of the vector space of real-valued functions of one real variable.
- (a) The *even* functions  $\{f: \mathbb{R} \rightarrow \mathbb{R} \mid f(-x) = f(x) \text{ for all } x\}$ . For example, two members of this set are  $f_1(x) = x^2$  and  $f_2(x) = \cos(x)$ .

(b) The *odd* functions  $\{f: \mathbb{R} \rightarrow \mathbb{R} \mid f(-x) = -f(x) \text{ for all } x\}$ . Two members are  $f_3(x) = x^3$  and  $f_4(x) = \sin(x)$ .

2.29 Example 2.16 says that for any vector  $\vec{v}$  that is an element of a vector space  $V$ , the set  $\{r \cdot \vec{v} \mid r \in \mathbb{R}\}$  is a subspace of  $V$ . (This is of course, simply the span of the singleton set  $\{\vec{v}\}$ .) Must any such subspace be a proper subspace, or can it be improper?

2.30 An example following the definition of a vector space shows that the solution set of a homogeneous linear system is a vector space. In the terminology of this subsection, it is a subspace of  $\mathbb{R}^n$  where the system has  $n$  variables. What about a non-homogeneous linear system; do its solutions form a subspace (under the inherited operations)?

2.31 [Cleary] Give an example of each or explain why it would be impossible to do so.

(a) A nonempty subset of  $\mathcal{M}_{2 \times 2}$  that is not a subspace.

(b) A set of two vectors in  $\mathbb{R}^2$  that does not span the space.

2.32 Example 2.19 shows that  $\mathbb{R}^3$  has infinitely many subspaces. Does every non-trivial space have infinitely many subspaces?

2.33 Finish the proof of Lemma 2.9.

2.34 Show that each vector space has only one trivial subspace.

✓ 2.35 Show that for any subset  $S$  of a vector space, the span of the span equals the span  $[[S]] = [S]$ . (*Hint.* Members of  $[S]$  are linear combinations of members of  $S$ . Members of  $[[S]]$  are linear combinations of linear combinations of members of  $S$ .)

2.36 All of the subspaces that we've seen use zero in their description in some way. For example, the subspace in Example 2.3 consists of all the vectors from  $\mathbb{R}^2$  with a second component of zero. In contrast, the collection of vectors from  $\mathbb{R}^2$  with a second component of one does not form a subspace (it is not closed under scalar multiplication). Another example is Example 2.2, where the condition on the vectors is that the three components add to zero. If the condition were that the three components add to one then it would not be a subspace (again, it would fail to be closed). This exercise shows that a reliance on zero is not strictly necessary. Consider the set

$$\left\{ \begin{pmatrix} x \\ y \\ z \end{pmatrix} \mid x + y + z = 1 \right\}$$

under these operations.

$$\begin{pmatrix} x_1 \\ y_1 \\ z_1 \end{pmatrix} + \begin{pmatrix} x_2 \\ y_2 \\ z_2 \end{pmatrix} = \begin{pmatrix} x_1 + x_2 - 1 \\ y_1 + y_2 \\ z_1 + z_2 \end{pmatrix} \quad r \begin{pmatrix} x \\ y \\ z \end{pmatrix} = \begin{pmatrix} rx - r + 1 \\ ry \\ rz \end{pmatrix}$$

(a) Show that it is not a subspace of  $\mathbb{R}^3$ . (*Hint.* See Example 2.5).

(b) Show that it is a vector space. Note that by the prior item, Lemma 2.9 can not apply.

(c) Show that any subspace of  $\mathbb{R}^3$  must pass through the origin, and so any subspace of  $\mathbb{R}^3$  must involve zero in its description. Does the converse hold? Does any subset of  $\mathbb{R}^3$  that contains the origin become a subspace when given the inherited operations?

2.37 We can give a justification for the convention that the sum of zero-many vectors equals the zero vector. Consider this sum of three vectors  $\vec{v}_1 + \vec{v}_2 + \vec{v}_3$ .

(a) What is the difference between this sum of three vectors and the sum of the first two of these three?

- (b) What is the difference between the prior sum and the sum of just the first one vector?
- (c) What should be the difference between the prior sum of one vector and the sum of no vectors?
- (d) So what should be the definition of the sum of no vectors?
- 2.38 Is a space determined by its subspaces? That is, if two vector spaces have the same subspaces, must the two be equal?
- 2.39 (a) Give a set that is closed under scalar multiplication but not addition.  
 (b) Give a set closed under addition but not scalar multiplication.  
 (c) Give a set closed under neither.
- 2.40 Show that the span of a set of vectors does not depend on the order in which the vectors are listed in that set.
- 2.41 Which trivial subspace is the span of the empty set? Is it

$$\left\{ \begin{pmatrix} 0 \\ 0 \\ 0 \end{pmatrix} \right\} \subseteq \mathbb{R}^3, \quad \text{or} \quad \{0 + 0x\} \subseteq \mathcal{P}_1,$$

or some other subspace?

- 2.42 Show that if a vector is in the span of a set then adding that vector to the set won't make the span any bigger. Is that also 'only if'?
- ✓ 2.43 Subspaces are subsets and so we naturally consider how 'is a subspace of' interacts with the usual set operations.  
 (a) If  $A, B$  are subspaces of a vector space, must their intersection  $A \cap B$  be a subspace? Always? Sometimes? Never?  
 (b) Must the union  $A \cup B$  be a subspace?  
 (c) If  $A$  is a subspace, must its complement be a subspace?  
 (*Hint.* Try some test subspaces from Example 2.19.)
- ✓ 2.44 Does the span of a set depend on the enclosing space? That is, if  $W$  is a subspace of  $V$  and  $S$  is a subset of  $W$  (and so also a subset of  $V$ ), might the span of  $S$  in  $W$  differ from the span of  $S$  in  $V$ ?
- 2.45 Is the relation 'is a subspace of' transitive? That is, if  $V$  is a subspace of  $W$  and  $W$  is a subspace of  $X$ , must  $V$  be a subspace of  $X$ ?
- ✓ 2.46 Because 'span of' is an operation on sets we naturally consider how it interacts with the usual set operations.  
 (a) If  $S \subseteq T$  are subsets of a vector space, is  $[S] \subseteq [T]$ ? Always? Sometimes? Never?  
 (b) If  $S, T$  are subsets of a vector space, is  $[S \cup T] = [S] \cup [T]$ ?  
 (c) If  $S, T$  are subsets of a vector space, is  $[S \cap T] = [S] \cap [T]$ ?  
 (d) Is the span of the complement equal to the complement of the span?
- 2.47 Reprove Lemma 2.15 without doing the empty set separately.
- 2.48 Find a structure that is closed under linear combinations, and yet is not a vector space. (*Remark.* This is a bit of a trick question.)



## II Linear Independence

The prior section shows that we can understand a vector space as a span, as an unrestricted linear combination of some of its elements. For example, the space of linear polynomials  $\{a + bx \mid a, b \in \mathbb{R}\}$  is spanned by the set  $\{1, x\}$ . The prior section also showed that a space can have many sets that span it. The space of linear polynomials is also spanned by  $\{1, 2x\}$  and  $\{1, x, 2x\}$ .

At the end of that section we described some spanning sets as ‘minimal’ but we never precisely defined that word. We could mean one of two things. We could mean that a spanning set is minimal if it contains the smallest number of members of any set with the same span. With this meaning  $\{1, x, 2x\}$  is not minimal because it has one member more than the other two. Or we could mean that a spanning set is minimal when it has no elements that we can remove without changing the span. Under this meaning  $\{1, x, 2x\}$  is not minimal because removing the  $2x$  and getting  $\{1, x\}$  leaves the span unchanged.

The first sense of minimality appears to be a global requirement, in that to check if a spanning set is minimal we seemingly must look at all the spanning sets of a subspace and find one with the least number of elements. The second sense of minimality is local in that we need to look only at the set under discussion and consider the span with and without various elements. For instance, using the second sense, we could compare the span of  $\{1, x, 2x\}$  with the span of  $\{1, x\}$  and note that the  $2x$  is a “repeat” in that its removal doesn’t shrink the span.

In this section we will use the second sense of ‘minimal spanning set’ because of this technical convenience. However, the most important result of this book is that the two senses coincide; we will prove that in the next section.

### II.1 Definition and Examples

**1.1 Lemma** If  $S$  is a subset of a vector space  $V$  and  $\vec{v} \in V$  then  $[S] = [S \cup \{\vec{v}\}]$  if and only if  $\vec{v} \in [S]$ .

**PROOF** The left to right implication is easy. If  $[S] = [S \cup \{\vec{v}\}]$  then, since  $\vec{v} \in [S \cup \{\vec{v}\}]$ , the equality of the two sets gives that  $\vec{v} \in [S]$ .

For the right to left implication assume that  $\vec{v} \in [S]$  to show that  $[S] = [S \cup \{\vec{v}\}]$  by mutual set inclusion. The inclusion  $[S] \subseteq [S \cup \{\vec{v}\}]$  is obvious. For  $[S] \supseteq [S \cup \{\vec{v}\}]$ , write an element of  $[S \cup \{\vec{v}\}]$  as  $d_0\vec{v} + d_1\vec{s}_1 + \cdots + d_m\vec{s}_m$  and substitute  $\vec{v}$ ’s expansion as a linear combination of members of the same set  $d_0(c_0\vec{t}_0 + \cdots + c_k\vec{t}_k) + d_1\vec{s}_1 + \cdots + d_m\vec{s}_m$ . This is a linear combination of linear combinations and so distributing  $d_0$  results in a linear combination of vectors from  $S$ . Hence each member of  $[S \cup \{\vec{v}\}]$  is also a member of  $[S]$ . QED

**1.2 Example** In  $\mathbb{R}^3$ , where

$$\vec{v}_1 = \begin{pmatrix} 1 \\ 0 \\ 0 \end{pmatrix} \quad \vec{v}_2 = \begin{pmatrix} 0 \\ 1 \\ 0 \end{pmatrix} \quad \vec{v}_3 = \begin{pmatrix} 2 \\ 1 \\ 0 \end{pmatrix}$$

the spans  $\{\vec{v}_1, \vec{v}_2\}$  and  $\{\vec{v}_1, \vec{v}_2, \vec{v}_3\}$  are equal since  $\vec{v}_3$  is in the span  $\{\vec{v}_1, \vec{v}_2\}$ .

The lemma says that if we have a spanning set then we can remove a  $\vec{v}$  to get a new set  $S$  with the same span if and only if  $\vec{v}$  is a linear combination of vectors from  $S$ . Thus, under the second sense described in this section's opening, a spanning set is minimal if and only if it contains no vectors that are linear combinations of the others in that set.

**1.3 Definition** A subset of a vector space is *linearly independent* if none of its elements is a linear combination of the others. Otherwise it is *linearly dependent*.

Here is an important observation: although this way of writing one vector as a combination of the others

$$\vec{s}_0 = c_1\vec{s}_1 + c_2\vec{s}_2 + \cdots + c_n\vec{s}_n$$

visually sets  $\vec{s}_0$  off from the other vectors, algebraically there is nothing special about it in that equation. For any  $\vec{s}_i$  with a coefficient  $c_i$  that is non-0 we can rewrite the relationship to set off  $\vec{s}_i$ .

$$\vec{s}_i = (1/c_i)\vec{s}_0 + \cdots + (-c_{i-1}/c_i)\vec{s}_{i-1} + (-c_{i+1}/c_i)\vec{s}_{i+1} + \cdots + (-c_n/c_i)\vec{s}_n$$

When we don't want to single out any vector by writing it alone on one side of the equation we will instead say that  $\vec{s}_0, \vec{s}_1, \dots, \vec{s}_n$  are in a *linear relationship* and write the relationship with all of the vectors on the same side. The next result rephrases the linear independence definition in this style. It gives what is usually the easiest way to compute whether a finite set is dependent or independent.

**1.4 Lemma** A subset  $S$  of a vector space is linearly independent if and only if among distinct  $\vec{s}_1, \dots, \vec{s}_n \in S$  the only linear relationship

$$c_1\vec{s}_1 + \cdots + c_n\vec{s}_n = \vec{0} \quad c_1, \dots, c_n \in \mathbb{R}$$

is the trivial one  $c_1 = 0, \dots, c_n = 0$ .

**PROOF** If the set  $S$  is linearly independent then no vector  $\vec{s}_i$  is a linear combination of other vectors from  $S$  so there is no linear relationship where some of the  $\vec{s}$ 's have nonzero coefficients.

If  $S$  is not linearly independent then some  $\vec{s}_i$  is a linear combination  $\vec{s}_i = c_1\vec{s}_1 + \cdots + c_{i-1}\vec{s}_{i-1} + c_{i+1}\vec{s}_{i+1} + \cdots + c_n\vec{s}_n$  of other vectors from  $S$ . Subtracting  $\vec{s}_i$  from both sides gives a relationship involving a nonzero coefficient, the  $-1$  in front of  $\vec{s}_i$ . QED

**1.5 Example** In the vector space of two-wide row vectors, the two-element set  $\left\{ \begin{pmatrix} 40 & 15 \end{pmatrix}, \begin{pmatrix} -50 & 25 \end{pmatrix} \right\}$  is linearly independent. To check this, set

$$c_1 \cdot \begin{pmatrix} 40 & 15 \end{pmatrix} + c_2 \cdot \begin{pmatrix} -50 & 25 \end{pmatrix} = \begin{pmatrix} 0 & 0 \end{pmatrix}$$

and solving the resulting system

$$\begin{array}{rcl} 40c_1 - 50c_2 = 0 & \xrightarrow{-(15/40)\rho_1 + \rho_2} & 40c_1 - 50c_2 = 0 \\ 15c_1 + 25c_2 = 0 & & (175/4)c_2 = 0 \end{array}$$

shows that both  $c_1$  and  $c_2$  are zero. So the only linear relationship between the two given row vectors is the trivial relationship.

In the same vector space,  $\left\{ \begin{pmatrix} 40 & 15 \end{pmatrix}, \begin{pmatrix} 20 & 7.5 \end{pmatrix} \right\}$  is linearly dependent since we can satisfy

$$c_1 \begin{pmatrix} 40 & 15 \end{pmatrix} + c_2 \cdot \begin{pmatrix} 20 & 7.5 \end{pmatrix} = \begin{pmatrix} 0 & 0 \end{pmatrix}$$

with  $c_1 = 1$  and  $c_2 = -2$ .

**1.6 Remark** Recall the Statics example that began this book. We first set the unknown-mass objects at 40 cm and 15 cm and got a balance, and then we set the objects at  $-50$  cm and 25 cm and got a balance. With those two pieces of information we could compute values of the unknown masses. Had we instead first set the unknown-mass objects at 40 cm and 15 cm, and then at 20 cm and 7.5 cm, we would not have been able to compute the values of the unknown masses. Intuitively, the problem is that the  $\begin{pmatrix} 20 & 7.5 \end{pmatrix}$  information is a “repeat” of the  $\begin{pmatrix} 40 & 15 \end{pmatrix}$  information—that is,  $\begin{pmatrix} 20 & 7.5 \end{pmatrix}$  is in the span of the set  $\left\{ \begin{pmatrix} 40 & 15 \end{pmatrix} \right\}$ —and so we would be trying to solve a two-unknowns problem with what is essentially one piece of information.

**1.7 Example** The set  $\{1 + x, 1 - x\}$  is linearly independent in  $\mathcal{P}_2$ , the space of quadratic polynomials with real coefficients, because

$$0 + 0x + 0x^2 = c_1(1 + x) + c_2(1 - x) = (c_1 + c_2) + (c_1 - c_2)x + 0x^2$$

gives

$$\begin{array}{rcl} c_1 + c_2 = 0 & \xrightarrow{-\rho_1 + \rho_2} & c_1 + c_2 = 0 \\ c_1 - c_2 = 0 & & 2c_2 = 0 \end{array}$$

since polynomials are equal only if their coefficients are equal. Thus, the only linear relationship between these two members of  $\mathcal{P}_2$  is the trivial one.

**1.8 Example** The rows of this matrix

$$A = \begin{pmatrix} 2 & 3 & 1 & 0 \\ 0 & -1 & 0 & -2 \\ 0 & 0 & 0 & 1 \end{pmatrix}$$

form a linearly independent set. This is easy to check but we know already that it is true: at the end of the first chapter, in Lemma One.III.2.4, we showed that the rows of any echelon form matrix are linearly independent.

**1.9 Example** In  $\mathbb{R}^3$ , where

$$\vec{v}_1 = \begin{pmatrix} 3 \\ 4 \\ 5 \end{pmatrix} \quad \vec{v}_2 = \begin{pmatrix} 2 \\ 9 \\ 2 \end{pmatrix} \quad \vec{v}_3 = \begin{pmatrix} 4 \\ 18 \\ 4 \end{pmatrix}$$

the set  $S = \{\vec{v}_1, \vec{v}_2, \vec{v}_3\}$  is linearly dependent because this is a relationship

$$0 \cdot \vec{v}_1 + 2 \cdot \vec{v}_2 - 1 \cdot \vec{v}_3 = \vec{0}$$

where not all of the scalars are zero (the fact that some of the scalars are zero doesn't matter).

**1.10 Remark** That example illustrates why, although Definition 1.3 is a clearer statement of what independence is, Lemma 1.4 is more useful for computations. Working straight from the definition, someone trying to compute whether  $S$  is linearly independent would start by setting  $\vec{v}_1 = c_2\vec{v}_2 + c_3\vec{v}_3$  and concluding that there are no such  $c_2$  and  $c_3$ . But knowing that the first vector is not dependent on the other two is not enough. This person would have to go on to try  $\vec{v}_2 = c_1\vec{v}_1 + c_3\vec{v}_3$  to find the dependence  $c_1 = 0$ ,  $c_3 = 1/2$ . Lemma 1.4 gets the same conclusion with only one computation.

**1.11 Example** The empty subset of a vector space is linearly independent. There is no nontrivial linear relationship among its members as it has no members.

**1.12 Example** In any vector space, any subset containing the zero vector is linearly dependent. For example, in the space  $\mathcal{P}_2$  of quadratic polynomials, consider the subset  $\{1 + x, x + x^2, 0\}$ .

One way to see that this subset is linearly dependent is to use Lemma 1.4: we have  $0 \cdot \vec{v}_1 + 0 \cdot \vec{v}_2 + 1 \cdot \vec{0} = \vec{0}$ , and this is a nontrivial relationship as not all of the coefficients are zero. Another way to see that this subset is linearly dependent is to go straight to Definition 1.3: we can express the third member of the subset as a linear combination of the first two, namely,  $c_1\vec{v}_1 + c_2\vec{v}_2 = \vec{0}$  is satisfied by taking  $c_1 = 0$  and  $c_2 = 0$  (in contrast to the lemma, the definition allows all of the coefficients to be zero).

There is a subtler way to see that this subset is dependent. The zero vector is equal to the trivial sum, the sum of the empty set. So a set containing the zero vector has an element that is a combination of a set of other vectors from the set, specifically, the zero vector is a combination of the empty set.

The above examples, especially Example 1.5, underline the discussion that begins this section. The next result says that given a finite set, we can produce a linearly independent subset by discarding what Remark 1.6 calls "repeats."

**1.13 Theorem** In a vector space, any finite subset has a linearly independent subset with the same span.

**PROOF** If the set  $S = \{\vec{s}_1, \dots, \vec{s}_n\}$  is linearly independent then  $S$  itself satisfies the statement, so assume that it is linearly dependent.

By the definition of dependence, there is a vector  $\vec{s}_i$  that is a linear combination of the others. Call that vector  $\vec{v}_1$ . Discard it: define the set  $S_1 = S - \{\vec{v}_1\}$ . By Lemma 1.1, the span does not shrink  $[S_1] = [S]$ .

Now, if  $S_1$  is linearly independent then we are finished. Otherwise iterate the prior paragraph: take a vector  $\vec{v}_2$  that is a linear combination of other members of  $S_1$  and discard it to derive  $S_2 = S_1 - \{\vec{v}_2\}$  such that  $[S_2] = [S_1]$ . Repeat this until a linearly independent set  $S_j$  appears; one must appear eventually because  $S$  is finite and the empty set is linearly independent. (Formally, this argument uses induction on  $n$ , the number of elements in the starting set. Exercise 39 asks for the details.) QED

**1.14 Example** This set spans  $\mathbb{R}^3$  (the check is routine).

$$S = \left\{ \begin{pmatrix} 1 \\ 0 \\ 0 \end{pmatrix}, \begin{pmatrix} 0 \\ 2 \\ 0 \end{pmatrix}, \begin{pmatrix} 1 \\ 2 \\ 0 \end{pmatrix}, \begin{pmatrix} 0 \\ -1 \\ 1 \end{pmatrix}, \begin{pmatrix} 3 \\ 3 \\ 0 \end{pmatrix} \right\}$$

Looking for a linear relationship

$$c_1 \begin{pmatrix} 1 \\ 0 \\ 0 \end{pmatrix} + c_2 \begin{pmatrix} 0 \\ 2 \\ 0 \end{pmatrix} + c_3 \begin{pmatrix} 1 \\ 2 \\ 0 \end{pmatrix} + c_4 \begin{pmatrix} 0 \\ -1 \\ 1 \end{pmatrix} + c_5 \begin{pmatrix} 3 \\ 3 \\ 0 \end{pmatrix} = \begin{pmatrix} 0 \\ 0 \\ 0 \end{pmatrix} \quad (*)$$

gives a system

$$\begin{aligned} c_1 + c_3 + 3c_5 &= 0 \\ 2c_2 + 2c_3 - c_4 + 3c_5 &= 0 \\ c_4 &= 0 \end{aligned}$$

with leading variables  $c_1$ ,  $c_2$ , and  $c_4$  and free variables  $c_3$  and  $c_5$ . Parametrizing the solution set

$$\left\{ \begin{pmatrix} c_1 \\ c_2 \\ c_3 \\ c_4 \\ c_5 \end{pmatrix} = c_3 \begin{pmatrix} -1 \\ -1 \\ 1 \\ 0 \\ 0 \end{pmatrix} + c_5 \begin{pmatrix} -3 \\ -3/2 \\ 0 \\ 0 \\ 1 \end{pmatrix} \mid c_3, c_5 \in \mathbb{R} \right\}$$

shows that there are nontrivial solutions to equation (\*). For instance, setting  $c_3 = 0$  and  $c_5 = 1$  gives that  $c_1 = -3$ ,  $c_2 = -3/2$ , and  $c_4 = 0$ , and so the fifth vector is a linear combination of the first two.

Because of that, Lemma 1.1 says that discarding the fifth vector to get

$$S_1 = \left\{ \begin{pmatrix} 1 \\ 0 \\ 0 \end{pmatrix}, \begin{pmatrix} 0 \\ 2 \\ 0 \end{pmatrix}, \begin{pmatrix} 1 \\ 2 \\ 0 \end{pmatrix}, \begin{pmatrix} 0 \\ -1 \\ 1 \end{pmatrix} \right\}$$

leaves the span unchanged  $[S_1] = [S]$ .

Similarly, setting  $c_3 = 1$  and  $c_5 = 0$  gives a linear dependence in equation (\*) above. Since  $c_5 = 0$  this is a relationship among the first four vectors, the

members of  $S_1$ . Thus we can discard  $c_3$ 's vector from  $S_1$  to get

$$S_2 = \left\{ \begin{pmatrix} 1 \\ 0 \\ 0 \end{pmatrix}, \begin{pmatrix} 0 \\ 2 \\ 0 \end{pmatrix}, \begin{pmatrix} 0 \\ -1 \\ 1 \end{pmatrix} \right\}$$

with the same span as  $S_1$ , and therefore the same span as  $S$ , but with one difference. We can easily check that  $S_2$  is linearly independent and so discarding any of its elements will shrink the span.

That example makes clear the general method: given a finite set of vectors, we first write the system to find a linear dependence. Then discarding any vectors associated with the free variables of that system will leave the span unchanged.

Theorem 1.13 describes producing a linearly independent set by shrinking, that is, by taking subsets. We finish this subsection by considering how linear independence and dependence, which are properties of sets, interact with the subset relation between sets.

**1.15 Lemma** Any subset of a linearly independent set is also linearly independent. Any superset of a linearly dependent set is also linearly dependent.

PROOF This is clear.

QED

Restated, independence is preserved by subset and dependence is preserved by superset.

Those are two of the four possible cases. The third case, whether linear dependence is preserved by the subset operation, is covered by Example 1.14, which gives a linearly dependent set  $S$  with a subset  $S_1$  that is linearly dependent and another subset  $S_2$  that is linearly independent.

That leaves one case, whether linear independence is preserved by superset. The next example shows what can happen.

**1.16 Example** In each of these three paragraphs the subset  $S$  is linearly independent.

For the set

$$S = \left\{ \begin{pmatrix} 1 \\ 0 \\ 0 \end{pmatrix} \right\}$$

the span  $[S]$  is the  $x$ -axis. Here are two supersets of  $S$ , one linearly dependent and the other linearly independent.

$$\text{dependent: } \left\{ \begin{pmatrix} 1 \\ 0 \\ 0 \end{pmatrix}, \begin{pmatrix} -3 \\ 0 \\ 0 \end{pmatrix} \right\} \quad \text{independent: } \left\{ \begin{pmatrix} 1 \\ 0 \\ 0 \end{pmatrix}, \begin{pmatrix} 0 \\ 1 \\ 0 \end{pmatrix} \right\}$$

Checking the dependence or independence of these sets is easy.

For

$$S = \left\{ \begin{pmatrix} 1 \\ 0 \\ 0 \end{pmatrix}, \begin{pmatrix} 0 \\ 1 \\ 0 \end{pmatrix} \right\}$$

the span  $[S]$  is the  $xy$ -plane. These are two supersets.

$$\text{dependent: } \left\{ \begin{pmatrix} 1 \\ 0 \\ 0 \end{pmatrix}, \begin{pmatrix} 0 \\ 1 \\ 0 \end{pmatrix}, \begin{pmatrix} 3 \\ -2 \\ 0 \end{pmatrix} \right\} \quad \text{independent: } \left\{ \begin{pmatrix} 1 \\ 0 \\ 0 \end{pmatrix}, \begin{pmatrix} 0 \\ 1 \\ 0 \end{pmatrix}, \begin{pmatrix} 0 \\ 0 \\ 1 \end{pmatrix} \right\}$$

If

$$S = \left\{ \begin{pmatrix} 1 \\ 0 \\ 0 \end{pmatrix}, \begin{pmatrix} 0 \\ 1 \\ 0 \end{pmatrix}, \begin{pmatrix} 0 \\ 0 \\ 1 \end{pmatrix} \right\}$$

then  $[S] = \mathbb{R}^3$ . A linearly dependent superset is

$$\text{dependent: } \left\{ \begin{pmatrix} 1 \\ 0 \\ 0 \end{pmatrix}, \begin{pmatrix} 0 \\ 1 \\ 0 \end{pmatrix}, \begin{pmatrix} 0 \\ 0 \\ 1 \end{pmatrix}, \begin{pmatrix} 2 \\ -1 \\ 3 \end{pmatrix} \right\}$$

but there are no linearly independent supersets of  $S$ . The reason is that for any vector that we would add to make a superset, the linear dependence equation

$$\begin{pmatrix} x \\ y \\ z \end{pmatrix} = c_1 \begin{pmatrix} 1 \\ 0 \\ 0 \end{pmatrix} + c_2 \begin{pmatrix} 0 \\ 1 \\ 0 \end{pmatrix} + c_3 \begin{pmatrix} 0 \\ 0 \\ 1 \end{pmatrix}$$

has a solution  $c_1 = x$ ,  $c_2 = y$ , and  $c_3 = z$ .

So, in general, a linearly independent set may have a superset that is dependent. And, in general, a linearly independent set may have a superset that is independent. We can characterize when the superset is one and when it is the other.

**1.17 Lemma** If  $S$  is a linearly independent subset of a vector space  $V$  then for any  $\vec{v} \in V$  with  $\vec{v} \notin S$ , the set  $S \cup \{\vec{v}\}$  is linearly dependent if and only if  $\vec{v} \in [S]$ .

**PROOF** The right-to-left implication is clear: if  $\vec{v} \in [S]$  then  $\vec{v} = c_1 \vec{s}_1 + c_2 \vec{s}_2 + \cdots + c_n \vec{s}_n$  where each  $\vec{s}_i \in S$  and  $c_i \in \mathbb{R}$ , and so  $\vec{0} = (-1)\vec{v} + c_1 \vec{s}_1 + c_2 \vec{s}_2 + \cdots + c_n \vec{s}_n$  is a nontrivial linear relationship among elements of  $S \cup \{\vec{v}\}$ .

The other implication requires the assumption that  $S$  is linearly independent. Suppose that  $S \cup \{\vec{v}\}$  is linearly dependent. Then there is a nontrivial  $c_0 \vec{v} + c_1 \vec{s}_1 + c_2 \vec{s}_2 + \cdots + c_n \vec{s}_n = \vec{0}$ , and independence of  $S$  then implies that  $c_0 \neq 0$  or else it would be a nontrivial relationship among members of  $S$ . Rewrite this equation as  $\vec{v} = -(c_1/c_0) \vec{s}_1 - \cdots - (c_n/c_0) \vec{s}_n$  to get that  $\vec{v} \in [S]$ . QED

(Compare this result with Lemma 1.1. Both say, roughly, that  $\vec{v}$  is a “repeat” if it is in the span of  $S$ . However, note the additional hypothesis here of linear independence.)

**1.18 Corollary** A subset  $S = \{\vec{s}_1, \dots, \vec{s}_n\}$  of a vector space is linearly dependent if and only if some  $\vec{s}_i$  is a linear combination of the vectors  $\vec{s}_1, \dots, \vec{s}_{i-1}$  listed before it.

**PROOF** Consider  $S_0 = \{\}$ ,  $S_1 = \{\vec{s}_1\}$ ,  $S_2 = \{\vec{s}_1, \vec{s}_2\}$ , etc. Some index  $i \geq 1$  is the first one with  $S_{i-1} \cup \{\vec{s}_i\}$  linearly dependent, and there  $\vec{s}_i \in [S_{i-1}]$ . QED

We can restate Lemma 1.17 in terms of independence instead of dependence: if  $S$  is linearly independent and  $\vec{v} \notin S$  then the set  $S \cup \{\vec{v}\}$  is also linearly independent if and only if  $\vec{v} \notin [S]$ . Applying Lemma 1.1, we conclude that if  $S$  is linearly independent and  $\vec{v} \notin S$  then  $S \cup \{\vec{v}\}$  is also linearly independent if and only if  $[S \cup \{\vec{v}\}] \neq [S]$ . Briefly, when passing from  $S$  to a superset  $S_1$ , to preserve linear independence we must expand the span  $[S_1] \supset [S]$ .

Example 1.16 shows that some linearly independent sets are maximal — have as many elements as possible — in that they have no supersets that are linearly independent. By the prior paragraph, a linearly independent sets is maximal if and only if it spans the entire space, because then no vector exists that is not already in the span.

This table summarizes the interaction between the properties of independence and dependence and the relations of subset and superset.

	$S_1 \subset S$	$S_1 \supset S$
$S$ independent	S <sub>1</sub> must be independent	S <sub>1</sub> may be either
$S$ dependent	S <sub>1</sub> may be either	S <sub>1</sub> must be dependent

In developing this table we've uncovered an intimate relationship between linear independence and span. Complementing the fact that a spanning set is minimal if and only if it is linearly independent, a linearly independent set is maximal if and only if it spans the space.

In summary, we have introduced the definition of linear independence to formalize the idea of the minimality of a spanning set. We have developed some properties of this idea. The most important is Lemma 1.17, which tells us that a linearly independent set is maximal when it spans the space.

### Exercises

✓ **1.19** Decide whether each subset of  $\mathbb{R}^3$  is linearly dependent or linearly independent.

(a)  $\left\{ \begin{pmatrix} 1 \\ -3 \\ 5 \end{pmatrix}, \begin{pmatrix} 2 \\ 2 \\ 4 \end{pmatrix}, \begin{pmatrix} 4 \\ -4 \\ 14 \end{pmatrix} \right\}$

(b)  $\left\{ \begin{pmatrix} 1 \\ 7 \\ 7 \end{pmatrix}, \begin{pmatrix} 2 \\ 7 \\ 7 \end{pmatrix}, \begin{pmatrix} 3 \\ 7 \\ 7 \end{pmatrix} \right\}$

(c)  $\left\{ \begin{pmatrix} 0 \\ 0 \\ -1 \end{pmatrix}, \begin{pmatrix} 1 \\ 0 \\ 4 \end{pmatrix} \right\}$



$$(d) \left\{ \begin{pmatrix} 9 \\ 9 \\ 0 \end{pmatrix}, \begin{pmatrix} 2 \\ 0 \\ 1 \end{pmatrix}, \begin{pmatrix} 3 \\ 5 \\ -4 \end{pmatrix}, \begin{pmatrix} 12 \\ 12 \\ -1 \end{pmatrix} \right\}$$

- ✓ 1.20 Which of these subsets of  $\mathcal{P}_3$  are linearly dependent and which are independent?

- (a)  $\{3 - x + 9x^2, 5 - 6x + 3x^2, 1 + 1x - 5x^2\}$   
 (b)  $\{-x^2, 1 + 4x^2\}$   
 (c)  $\{2 + x + 7x^2, 3 - x + 2x^2, 4 - 3x^2\}$   
 (d)  $\{8 + 3x + 3x^2, x + 2x^2, 2 + 2x + 2x^2, 8 - 2x + 5x^2\}$

- ✓ 1.21 Prove that each set  $\{f, g\}$  is linearly independent in the vector space of all functions from  $\mathbb{R}^+$  to  $\mathbb{R}$ .

- (a)  $f(x) = x$  and  $g(x) = 1/x$   
 (b)  $f(x) = \cos(x)$  and  $g(x) = \sin(x)$   
 (c)  $f(x) = e^x$  and  $g(x) = \ln(x)$

- ✓ 1.22 Which of these subsets of the space of real-valued functions of one real variable is linearly dependent and which is linearly independent? (Note that we have abbreviated some constant functions; e.g., in the first item, the '2' stands for the constant function  $f(x) = 2$ .)

- (a)  $\{2, 4 \sin^2(x), \cos^2(x)\}$     (b)  $\{1, \sin(x), \sin(2x)\}$     (c)  $\{x, \cos(x)\}$   
 (d)  $\{(1+x)^2, x^2 + 2x, 3\}$     (e)  $\{\cos(2x), \sin^2(x), \cos^2(x)\}$     (f)  $\{0, x, x^2\}$

- 1.23 Does the equation  $\sin^2(x)/\cos^2(x) = \tan^2(x)$  show that this set of functions  $\{\sin^2(x), \cos^2(x), \tan^2(x)\}$  is a linearly dependent subset of the set of all real-valued functions with domain the interval  $(-\pi/2, \pi/2)$  of real numbers between  $-\pi/2$  and  $\pi/2$ ?

- 1.24 Why does Lemma 1.4 say "distinct"?

- ✓ 1.25 Show that the nonzero rows of an echelon form matrix form a linearly independent set.

- ✓ 1.26 (a) Show that if the set  $\{\vec{u}, \vec{v}, \vec{w}\}$  is linearly independent set then so is the set  $\{\vec{u}, \vec{u} + \vec{v}, \vec{u} + \vec{v} + \vec{w}\}$ .

- (b) What is the relationship between the linear independence or dependence of the set  $\{\vec{u}, \vec{v}, \vec{w}\}$  and the independence or dependence of  $\{\vec{u} - \vec{v}, \vec{v} - \vec{w}, \vec{w} - \vec{u}\}$ ?

- 1.27 Example 1.11 shows that the empty set is linearly independent.

- (a) When is a one-element set linearly independent?  
 (b) How about a set with two elements?

- 1.28 In any vector space  $V$ , the empty set is linearly independent. What about all of  $V$ ?

- 1.29 Show that if  $\{\vec{x}, \vec{y}, \vec{z}\}$  is linearly independent then so are all of its proper subsets:  $\{\vec{x}, \vec{y}\}$ ,  $\{\vec{x}, \vec{z}\}$ ,  $\{\vec{y}, \vec{z}\}$ ,  $\{\vec{x}\}$ ,  $\{\vec{y}\}$ ,  $\{\vec{z}\}$ , and  $\{\}$ . Is that 'only if' also?

- 1.30 (a) Show that this

$$S = \left\{ \begin{pmatrix} 1 \\ 1 \\ 0 \end{pmatrix}, \begin{pmatrix} -1 \\ 2 \\ 0 \end{pmatrix} \right\}$$

is a linearly independent subset of  $\mathbb{R}^3$ .

- (b) Show that

$$\begin{pmatrix} 3 \\ 2 \\ 0 \end{pmatrix}$$

is in the span of  $S$  by finding  $c_1$  and  $c_2$  giving a linear relationship.

$$c_1 \begin{pmatrix} 1 \\ 1 \\ 0 \end{pmatrix} + c_2 \begin{pmatrix} -1 \\ 2 \\ 0 \end{pmatrix} = \begin{pmatrix} 3 \\ 2 \\ 0 \end{pmatrix}$$

Show that the pair  $c_1, c_2$  is unique.

(c) Assume that  $S$  is a subset of a vector space and that  $\vec{v}$  is in  $[S]$ , so that  $\vec{v}$  is a linear combination of vectors from  $S$ . Prove that if  $S$  is linearly independent then a linear combination of vectors from  $S$  adding to  $\vec{v}$  is unique (that is, unique up to reordering and adding or taking away terms of the form  $0 \cdot \vec{s}$ ). Thus  $S$  as a spanning set is minimal in this strong sense: each vector in  $[S]$  is “hit” a minimum number of times—only once.

(d) Prove that it can happen when  $S$  is not linearly independent that distinct linear combinations sum to the same vector.

**1.31** Prove that a polynomial gives rise to the zero function if and only if it is the zero polynomial. (*Comment.* This question is not a Linear Algebra matter, but we often use the result. A polynomial gives rise to a function in the natural way:  $x \mapsto c_n x^n + \cdots + c_1 x + c_0$ .)

**1.32** Return to Section 1.2 and redefine point, line, plane, and other linear surfaces to avoid degenerate cases.

**1.33** (a) Show that any set of four vectors in  $\mathbb{R}^2$  is linearly dependent.

(b) Is this true for any set of five? Any set of three?

(c) What is the most number of elements that a linearly independent subset of  $\mathbb{R}^2$  can have?

✓ **1.34** Is there a set of four vectors in  $\mathbb{R}^3$ , any three of which form a linearly independent set?

**1.35** Must every linearly dependent set have a subset that is dependent and a subset that is independent?

**1.36** In  $\mathbb{R}^4$ , what is the biggest linearly independent set you can find? The smallest? The biggest linearly dependent set? The smallest? (‘Biggest’ and ‘smallest’ mean that there are no supersets or subsets with the same property.)

✓ **1.37** Linear independence and linear dependence are properties of sets. We can thus naturally ask how those properties act with respect to the familiar elementary set relations and operations. In this body of this subsection we have covered the subset and superset relations. We can also consider the operations of intersection, complementation, and union.

(a) How does linear independence relate to intersection: can an intersection of linearly independent sets be independent? Must it be?

(b) How does linear independence relate to complementation?

(c) Show that the union of two linearly independent sets can be linearly independent.

(d) Show that the union of two linearly independent sets need not be linearly independent.

**1.38** *Continued from prior exercise.* What is the interaction between the property of linear independence and the operation of union?

(a) We might conjecture that the union  $S \cup T$  of linearly independent sets is linearly independent if and only if their spans have a trivial intersection  $[S] \cap [T] = \{\vec{0}\}$ . What is wrong with this argument for the ‘if’ direction of that conjecture? “If the union  $S \cup T$  is linearly independent then the only solution to  $c_1 \vec{s}_1 + \cdots + c_n \vec{s}_n + d_1 \vec{t}_1 + \cdots + d_m \vec{t}_m = \vec{0}$  is the trivial one  $c_1 = 0, \dots, d_m = 0$ . So any

member of the intersection of the spans must be the zero vector because in  $c_1\vec{s}_1 + \cdots + c_n\vec{s}_n = d_1\vec{t}_1 + \cdots + d_m\vec{t}_m$  each scalar is zero."

- (b) Give an example showing that the conjecture is false.  
 (c) Find linearly independent sets  $S$  and  $T$  so that the union of  $S - (S \cap T)$  and  $T - (S \cap T)$  is linearly independent, but the union  $S \cup T$  is not linearly independent.  
 (d) Characterize when the union of two linearly independent sets is linearly independent, in terms of the intersection of spans.
- ✓ 1.39 For Theorem 1.13,  
 (a) fill in the induction for the proof;  
 (b) give an alternate proof that starts with the empty set and builds a sequence of linearly independent subsets of the given finite set until one appears with the same span as the given set.

1.40 With a little calculation we can get formulas to determine whether or not a set of vectors is linearly independent.

- (a) Show that this subset of  $\mathbb{R}^2$

$$\left\{ \begin{pmatrix} a \\ c \end{pmatrix}, \begin{pmatrix} b \\ d \end{pmatrix} \right\}$$

is linearly independent if and only if  $ad - bc \neq 0$ .

- (b) Show that this subset of  $\mathbb{R}^3$

$$\left\{ \begin{pmatrix} a \\ d \\ g \end{pmatrix}, \begin{pmatrix} b \\ e \\ h \end{pmatrix}, \begin{pmatrix} c \\ f \\ i \end{pmatrix} \right\}$$

is linearly independent iff  $aei + bfg + cdh - hfa - idb - gec \neq 0$ .

- (c) When is this subset of  $\mathbb{R}^3$

$$\left\{ \begin{pmatrix} a \\ d \\ g \end{pmatrix}, \begin{pmatrix} b \\ e \\ h \end{pmatrix} \right\}$$

linearly independent?

- (d) This is an opinion question: for a set of four vectors from  $\mathbb{R}^4$ , must there be a formula involving the sixteen entries that determines independence of the set? (You needn't produce such a formula, just decide if one exists.)
- ✓ 1.41 (a) Prove that a set of two perpendicular nonzero vectors from  $\mathbb{R}^n$  is linearly independent when  $n > 1$ .  
 (b) What if  $n = 1$ ?  $n = 0$ ?  
 (c) Generalize to more than two vectors.

1.42 Consider the set of functions from the open interval  $(-1, 1)$  to  $\mathbb{R}$ .

- (a) Show that this set is a vector space under the usual operations.  
 (b) Recall the formula for the sum of an infinite geometric series:  $1 + x + x^2 + \cdots = 1/(1 - x)$  for all  $x \in (-1, 1)$ . Why does this not express a dependence inside of the set  $\{g(x) = 1/(1 - x), f_0(x) = 1, f_1(x) = x, f_2(x) = x^2, \dots\}$  (in the vector space that we are considering)? (*Hint.* Review the definition of linear combination.)  
 (c) Show that the set in the prior item is linearly independent.

This shows that some vector spaces exist with linearly independent subsets that are infinite.

1.43 Show that, where  $S$  is a subspace of  $V$ , if a subset  $T$  of  $S$  is linearly independent in  $S$  then  $T$  is also linearly independent in  $V$ . Is that 'only if'?

### III Basis and Dimension

The prior section ends with the statement that a spanning set is minimal when it is linearly independent and a linearly independent set is maximal when it spans the space. So the notions of minimal spanning set and maximal independent set coincide. In this section we will name this idea and study its properties.

#### III.1 Basis

**1.1 Definition** A *basis* for a vector space is a sequence of vectors that form a set that is linearly independent and that spans the space.

We denote a basis with angle brackets  $\langle \vec{\beta}_1, \vec{\beta}_2, \dots \rangle$  to signify that this collection is a sequence,\* meaning that the order of the elements is significant. Bases are different if they contain the same elements but in different orders.

**1.2 Example** This is a basis for  $\mathbb{R}^2$ .

$$\left\langle \begin{pmatrix} 2 \\ 4 \end{pmatrix}, \begin{pmatrix} 1 \\ 1 \end{pmatrix} \right\rangle$$

It is linearly independent

$$c_1 \begin{pmatrix} 2 \\ 4 \end{pmatrix} + c_2 \begin{pmatrix} 1 \\ 1 \end{pmatrix} = \begin{pmatrix} 0 \\ 0 \end{pmatrix} \implies \begin{matrix} 2c_1 + 1c_2 = 0 \\ 4c_1 + 1c_2 = 0 \end{matrix} \implies c_1 = c_2 = 0$$

and it spans  $\mathbb{R}^2$ .

$$\begin{matrix} 2c_1 + 1c_2 = x \\ 4c_1 + 1c_2 = y \end{matrix} \implies c_2 = 2x - y \text{ and } c_1 = (y - x)/2$$

**1.3 Example** This basis for  $\mathbb{R}^2$

$$\left\langle \begin{pmatrix} 1 \\ 1 \end{pmatrix}, \begin{pmatrix} 2 \\ 4 \end{pmatrix} \right\rangle$$

differs from the prior one because the vectors are in a different order. The verification that it is a basis is just as in the prior example.

**1.4 Example** The space  $\mathbb{R}^2$  has many bases. Another one is this.

$$\left\langle \begin{pmatrix} 1 \\ 0 \end{pmatrix}, \begin{pmatrix} 0 \\ 1 \end{pmatrix} \right\rangle$$

The verification is easy.

---

\* More information on sequences is in the appendix.

**1.5 Definition** For any  $\mathbb{R}^n$ ,

$$\mathcal{E}_n = \left\langle \begin{pmatrix} 1 \\ 0 \\ \vdots \\ 0 \end{pmatrix}, \begin{pmatrix} 0 \\ 1 \\ \vdots \\ 0 \end{pmatrix}, \dots, \begin{pmatrix} 0 \\ 0 \\ \vdots \\ 1 \end{pmatrix} \right\rangle$$

is the *standard* (or *natural*) basis. We denote these vectors by  $\vec{e}_1, \dots, \vec{e}_n$ .

Calculus books refer to  $\mathbb{R}^2$ 's standard basis vectors  $\vec{i}$  and  $\vec{j}$  instead of  $\vec{e}_1$  and  $\vec{e}_2$ , and they refer to  $\mathbb{R}^3$ 's standard basis vectors  $\vec{i}$ ,  $\vec{j}$ , and  $\vec{k}$  instead of  $\vec{e}_1$ ,  $\vec{e}_2$ , and  $\vec{e}_3$ . Note that  $\vec{e}_1$  means something different in a discussion of  $\mathbb{R}^3$  than it means in a discussion of  $\mathbb{R}^2$ .

**1.6 Example** Consider the space  $\{a \cdot \cos \theta + b \cdot \sin \theta \mid a, b \in \mathbb{R}\}$  of functions of the real variable  $\theta$ . This is a natural basis.

$$\langle 1 \cdot \cos \theta + 0 \cdot \sin \theta, 0 \cdot \cos \theta + 1 \cdot \sin \theta \rangle = \langle \cos \theta, \sin \theta \rangle$$

Another, more generic, basis is  $\langle \cos \theta - \sin \theta, 2 \cos \theta + 3 \sin \theta \rangle$ . Verification that these two are bases is Exercise 22.

**1.7 Example** A natural basis for the vector space of cubic polynomials  $\mathcal{P}_3$  is  $\langle 1, x, x^2, x^3 \rangle$ . Two other bases for this space are  $\langle x^3, 3x^2, 6x, 6 \rangle$  and  $\langle 1, 1 + x, 1 + x + x^2, 1 + x + x^2 + x^3 \rangle$ . Checking that these are linearly independent and span the space is easy.

**1.8 Example** The trivial space  $\{\vec{0}\}$  has only one basis, the empty one  $\langle \rangle$ .

**1.9 Example** The space of finite-degree polynomials has a basis with infinitely many elements  $\langle 1, x, x^2, \dots \rangle$ .

**1.10 Example** We have seen bases before. In the first chapter we described the solution set of homogeneous systems such as this one

$$\begin{aligned} x + y - w &= 0 \\ z + w &= 0 \end{aligned}$$

by parametrizing.

$$\left\{ \begin{pmatrix} -1 \\ 1 \\ 0 \\ 0 \end{pmatrix} y + \begin{pmatrix} 1 \\ 0 \\ -1 \\ 1 \end{pmatrix} w \mid y, w \in \mathbb{R} \right\}$$

Thus the vector space of solutions is the span of a two-element set. This two-vector set is also linearly independent; that is easy to check. Therefore the solution set is a subspace of  $\mathbb{R}^4$  with a basis comprised of the above two elements.

**1.11 Example** Parametrization helps find bases for other vector spaces, not just for solution sets of homogeneous systems. To find a basis for this subspace of

$\mathcal{M}_{2 \times 2}$

$$\left\{ \begin{pmatrix} a & b \\ c & 0 \end{pmatrix} \mid a + b - 2c = 0 \right\}$$

we rewrite the condition as  $a = -b + 2c$ .

$$\left\{ \begin{pmatrix} -b + 2c & b \\ c & 0 \end{pmatrix} \mid b, c \in \mathbb{R} \right\} = \left\{ b \begin{pmatrix} -1 & 1 \\ 0 & 0 \end{pmatrix} + c \begin{pmatrix} 2 & 0 \\ 1 & 0 \end{pmatrix} \mid b, c \in \mathbb{R} \right\}$$

Thus, this is a natural candidate for a basis.

$$\left\langle \begin{pmatrix} -1 & 1 \\ 0 & 0 \end{pmatrix}, \begin{pmatrix} 2 & 0 \\ 1 & 0 \end{pmatrix} \right\rangle$$

The above work shows that it spans the space. Linear independence is also easy.

Consider again Example 1.2. To verify linearly independence we looked at linear combinations of the set's members that total to the zero vector  $c_1 \vec{\beta}_1 + c_2 \vec{\beta}_2 = \begin{pmatrix} 0 \\ 0 \end{pmatrix}$ . The resulting calculation shows that such a combination is unique, that  $c_1$  must be 0 and  $c_2$  must be 0. To verify that the set spans the space we looked at linear combinations that total to any member of the space  $c_1 \vec{\beta}_1 + c_2 \vec{\beta}_2 = \begin{pmatrix} x \\ y \end{pmatrix}$ . We only noted in that example that such a combination exists, that for each  $x, y$  there is a  $c_1, c_2$ , but in fact the calculation also shows that the combination is unique:  $c_1$  must be  $(y - x)/2$  and  $c_2$  must be  $2x - y$ .

**1.12 Theorem** In any vector space, a subset is a basis if and only if each vector in the space can be expressed as a linear combination of elements of the subset in a unique way.

We consider linear combinations to be the same if they differ only in the order of summands or in the addition or deletion of terms of the form ' $0 \cdot \vec{\beta}$ '.

**PROOF** A sequence is a basis if and only if its vectors form a set that spans and that is linearly independent. And, a subset is a spanning set if and only if each vector in the space is a linear combination of elements of that subset in at least one way. Thus we need only show that a spanning subset is linearly independent if and only if every vector in the space is a linear combination of elements from the subset in at most one way.

Consider two expressions of a vector as a linear combination of the members of the subset. We can rearrange the two sums and if necessary add some  $0\vec{\beta}_i$  terms so that the two sums combine the same  $\vec{\beta}$ 's in the same order:  $\vec{v} = c_1 \vec{\beta}_1 + c_2 \vec{\beta}_2 + \cdots + c_n \vec{\beta}_n$  and  $\vec{v} = d_1 \vec{\beta}_1 + d_2 \vec{\beta}_2 + \cdots + d_n \vec{\beta}_n$ . Now

$$c_1 \vec{\beta}_1 + c_2 \vec{\beta}_2 + \cdots + c_n \vec{\beta}_n = d_1 \vec{\beta}_1 + d_2 \vec{\beta}_2 + \cdots + d_n \vec{\beta}_n$$

holds if and only if

$$(c_1 - d_1) \vec{\beta}_1 + \cdots + (c_n - d_n) \vec{\beta}_n = \vec{0}$$

holds. So, asserting that each coefficient in the lower equation is zero is the same thing as asserting that  $c_i = d_i$  for each  $i$ , that is, that every vector is expressible as a linear combination of the  $\vec{\beta}$ 's in a unique way. QED

**1.13 Definition** In a vector space with basis  $B$  the *representation of  $\vec{v}$  with respect to  $B$*  is the column vector of the coefficients used to express  $\vec{v}$  as a linear combination of the basis vectors:

$$\text{Rep}_B(\vec{v}) = \begin{pmatrix} c_1 \\ c_2 \\ \vdots \\ c_n \end{pmatrix}$$

where  $B = \langle \vec{\beta}_1, \dots, \vec{\beta}_n \rangle$  and  $\vec{v} = c_1\vec{\beta}_1 + c_2\vec{\beta}_2 + \dots + c_n\vec{\beta}_n$ . The  $c$ 's are the *coordinates of  $\vec{v}$  with respect to  $B$* .

Definition 1.1 requires that a basis is a sequence, that the order of the basis elements matters, in order to make this definition possible. Without that requirement we couldn't write these  $c_i$ 's in order.

We will later do representations in contexts that involve more than one basis. To help keep straight which representation is with respect to which basis we shall often write the basis name as a subscript on the column vector.

**1.14 Example** In  $\mathcal{P}_3$ , with respect to the basis  $B = \langle 1, 2x, 2x^2, 2x^3 \rangle$ , the representation of  $x + x^2$  is

$$\text{Rep}_B(x + x^2) = \begin{pmatrix} 0 \\ 1/2 \\ 1/2 \\ 0 \end{pmatrix}_B$$

(note that the coordinates are scalars, not vectors). With respect to a different basis  $D = \langle 1 + x, 1 - x, x + x^2, x + x^3 \rangle$ , the representation

$$\text{Rep}_D(x + x^2) = \begin{pmatrix} 0 \\ 0 \\ 1 \\ 0 \end{pmatrix}_D$$

is different.

**1.15 Remark** This use of column notation and the term 'coordinates' has both a down side and an up side.

The down side is that representations look like vectors from  $\mathbb{R}^n$ , which can be confusing when the vector space we are working with is  $\mathbb{R}^n$ , especially since we sometimes omit the subscript base. We must then infer the intent from the context. For example, the phrase 'in  $\mathbb{R}^2$ , where  $\vec{v} = \begin{pmatrix} 3 \\ 2 \end{pmatrix}$ ' refers to the plane vector that, when in canonical position, ends at  $(3, 2)$ . To find the coordinates

of that vector with respect to the basis

$$B = \left\langle \begin{pmatrix} 1 \\ 1 \end{pmatrix}, \begin{pmatrix} 0 \\ 2 \end{pmatrix} \right\rangle$$

we solve

$$c_1 \begin{pmatrix} 1 \\ 1 \end{pmatrix} + c_2 \begin{pmatrix} 0 \\ 2 \end{pmatrix} = \begin{pmatrix} 3 \\ 2 \end{pmatrix}$$

to get that  $c_1 = 3$  and  $c_2 = 1/2$ . Then we have this.

$$\text{Rep}_B(\vec{v}) = \begin{pmatrix} 3 \\ -1/2 \end{pmatrix}$$

Here, although we've omitted the subscript  $B$  from the column, the fact that the right side is a representation is clear from the context.

The advantage the notation and the term 'coordinates' is that they generalize the familiar case: in  $\mathbb{R}^n$  and with respect to the standard basis  $\mathcal{E}_n$ , the vector starting at the origin and ending at  $(v_1, \dots, v_n)$  has this representation.

$$\text{Rep}_{\mathcal{E}_n} \left( \begin{pmatrix} v_1 \\ \vdots \\ v_n \end{pmatrix} \right) = \begin{pmatrix} v_1 \\ \vdots \\ v_n \end{pmatrix}_{\mathcal{E}_n}$$

Our main use of representations will come in the third chapter. The definition appears here because the fact that every vector is a linear combination of basis vectors in a unique way is a crucial property of bases, and also to help make two points. First, we fix an order for the elements of a basis so that we can state the coordinates in that order. Second, for calculation of coordinates, among other things, we shall restrict our attention to spaces with bases having only finitely many elements. We will see that in the next subsection.

### Exercises

✓ **1.16** Decide if each is a basis for  $\mathbb{R}^3$ .

$$(a) \left\langle \begin{pmatrix} 1 \\ 2 \\ 3 \end{pmatrix}, \begin{pmatrix} 3 \\ 2 \\ 1 \end{pmatrix}, \begin{pmatrix} 0 \\ 0 \\ 1 \end{pmatrix} \right\rangle \quad (b) \left\langle \begin{pmatrix} 1 \\ 2 \\ 3 \end{pmatrix}, \begin{pmatrix} 3 \\ 2 \\ 1 \end{pmatrix} \right\rangle \quad (c) \left\langle \begin{pmatrix} 0 \\ 2 \\ -1 \end{pmatrix}, \begin{pmatrix} 1 \\ 1 \\ 1 \end{pmatrix}, \begin{pmatrix} 2 \\ 5 \\ 0 \end{pmatrix} \right\rangle$$

$$(d) \left\langle \begin{pmatrix} 0 \\ 2 \\ -1 \end{pmatrix}, \begin{pmatrix} 1 \\ 1 \\ 1 \end{pmatrix}, \begin{pmatrix} 1 \\ 3 \\ 0 \end{pmatrix} \right\rangle$$

✓ **1.17** Represent the vector with respect to the basis.

$$(a) \begin{pmatrix} 1 \\ 2 \end{pmatrix}, B = \left\langle \begin{pmatrix} 1 \\ 1 \end{pmatrix}, \begin{pmatrix} -1 \\ 1 \end{pmatrix} \right\rangle \subseteq \mathbb{R}^2$$

$$(b) x^2 + x^3, D = \langle 1, 1 + x, 1 + x + x^2, 1 + x + x^2 + x^3 \rangle \subseteq \mathcal{P}_3$$

$$(c) \begin{pmatrix} 0 \\ -1 \\ 0 \\ 1 \end{pmatrix}, \mathcal{E}_4 \subseteq \mathbb{R}^4$$



1.18 Find a basis for  $\mathcal{P}_2$ , the space of all quadratic polynomials. Must any such basis contain a polynomial of each degree: degree zero, degree one, and degree two?

1.19 Find a basis for the solution set of this system.

$$\begin{aligned}x_1 - 4x_2 + 3x_3 - x_4 &= 0 \\2x_1 - 8x_2 + 6x_3 - 2x_4 &= 0\end{aligned}$$

✓ 1.20 Find a basis for  $\mathcal{M}_{2 \times 2}$ , the space of  $2 \times 2$  matrices.

✓ 1.21 Find a basis for each.

(a) The subspace  $\{a_2x^2 + a_1x + a_0 \mid a_2 - 2a_1 = a_0\}$  of  $\mathcal{P}_2$

(b) The space of three-wide row vectors whose first and second components add to zero

(c) This subspace of the  $2 \times 2$  matrices

$$\left\{ \begin{pmatrix} a & b \\ 0 & c \end{pmatrix} \mid c - 2b = 0 \right\}$$

1.22 Check Example 1.6.

✓ 1.23 Find the span of each set and then find a basis for that span.

(a)  $\{1 + x, 1 + 2x\}$  in  $\mathcal{P}_2$     (b)  $\{2 - 2x, 3 + 4x^2\}$  in  $\mathcal{P}_2$

✓ 1.24 Find a basis for each of these subspaces of the space  $\mathcal{P}_3$  of cubic polynomials.

(a) The subspace of cubic polynomials  $p(x)$  such that  $p(7) = 0$

(b) The subspace of polynomials  $p(x)$  such that  $p(7) = 0$  and  $p(5) = 0$

(c) The subspace of polynomials  $p(x)$  such that  $p(7) = 0$ ,  $p(5) = 0$ , and  $p(3) = 0$

(d) The space of polynomials  $p(x)$  such that  $p(7) = 0$ ,  $p(5) = 0$ ,  $p(3) = 0$ , and  $p(1) = 0$

1.25 We've seen that the result of reordering a basis can be another basis. Must it be?

1.26 Can a basis contain a zero vector?

✓ 1.27 Let  $\langle \vec{\beta}_1, \vec{\beta}_2, \vec{\beta}_3 \rangle$  be a basis for a vector space.

(a) Show that  $\langle c_1\vec{\beta}_1, c_2\vec{\beta}_2, c_3\vec{\beta}_3 \rangle$  is a basis when  $c_1, c_2, c_3 \neq 0$ . What happens when at least one  $c_i$  is 0?

(b) Prove that  $\langle \vec{\alpha}_1, \vec{\alpha}_2, \vec{\alpha}_3 \rangle$  is a basis where  $\vec{\alpha}_i = \vec{\beta}_1 + \vec{\beta}_i$ .

1.28 Find one vector  $\vec{v}$  that will make each into a basis for the space.

(a)  $\left\langle \begin{pmatrix} 1 \\ 1 \end{pmatrix}, \vec{v} \right\rangle$  in  $\mathbb{R}^2$     (b)  $\left\langle \begin{pmatrix} 1 \\ 1 \\ 0 \end{pmatrix}, \begin{pmatrix} 0 \\ 1 \\ 0 \end{pmatrix}, \vec{v} \right\rangle$  in  $\mathbb{R}^3$     (c)  $\langle x, 1 + x^2, \vec{v} \rangle$  in  $\mathcal{P}_2$

✓ 1.29 Where  $\langle \vec{\beta}_1, \dots, \vec{\beta}_n \rangle$  is a basis, show that in this equation

$$c_1\vec{\beta}_1 + \dots + c_k\vec{\beta}_k = c_{k+1}\vec{\beta}_{k+1} + \dots + c_n\vec{\beta}_n$$

each of the  $c_i$ 's is zero. Generalize.

1.30 A basis contains some of the vectors from a vector space; can it contain them all?

1.31 Theorem 1.12 shows that, with respect to a basis, every linear combination is unique. If a subset is not a basis, can linear combinations be not unique? If so, must they be?

✓ 1.32 A square matrix is *symmetric* if for all indices  $i$  and  $j$ , entry  $i, j$  equals entry  $j, i$ .

(a) Find a basis for the vector space of symmetric  $2 \times 2$  matrices.

(b) Find a basis for the space of symmetric  $3 \times 3$  matrices.

(c) Find a basis for the space of symmetric  $n \times n$  matrices.

✓ 1.33 We can show that every basis for  $\mathbb{R}^3$  contains the same number of vectors.

(a) Show that no linearly independent subset of  $\mathbb{R}^3$  contains more than three vectors.

(b) Show that no spanning subset of  $\mathbb{R}^3$  contains fewer than three vectors. *Hint:* recall how to calculate the span of a set and show that this method cannot yield all of  $\mathbb{R}^3$  when we apply it to fewer than three vectors.

1.34 One of the exercises in the Subspaces subsection shows that the set

$$\left\{ \begin{pmatrix} x \\ y \\ z \end{pmatrix} \mid x + y + z = 1 \right\}$$

is a vector space under these operations.

$$\begin{pmatrix} x_1 \\ y_1 \\ z_1 \end{pmatrix} + \begin{pmatrix} x_2 \\ y_2 \\ z_2 \end{pmatrix} = \begin{pmatrix} x_1 + x_2 - 1 \\ y_1 + y_2 \\ z_1 + z_2 \end{pmatrix} \quad r \begin{pmatrix} x \\ y \\ z \end{pmatrix} = \begin{pmatrix} rx - r + 1 \\ ry \\ rz \end{pmatrix}$$

Find a basis.

## III.2 Dimension

In the prior subsection we defined the basis of a vector space and we saw that a space can have many different bases. So we cannot talk about “the” basis for a vector space. True, some vector spaces have bases that strike us as more natural than others, for instance,  $\mathbb{R}^2$ 's basis  $\mathcal{E}_2$  or  $\mathcal{P}_2$ 's basis  $\langle 1, x, x^2 \rangle$ . But for the vector space  $\{a_2x^2 + a_1x + a_0 \mid 2a_2 - a_0 = a_1\}$ , no particular basis leaps out at us as the natural one. We cannot, in general, associate with a space any single basis that best describes that space.

We can however find something about the bases that is uniquely associated with the space. This subsection shows that any two bases for a space have the same number of elements. So with each space we can associate a number, the number of vectors in any of its bases.

Before we start, we first limit our attention to spaces where at least one basis has only finitely many members.

**2.1 Definition** A vector space is *finite-dimensional* if it has a basis with only finitely many vectors.

A space that is not finite-dimensional is the set of polynomials with real coefficients Example 1.11 (this space is not spanned by any finite subset since that would contain a polynomial of largest degree but this space has polynomials of all degrees). These spaces are interesting and important, but we will focus in a different direction. From now on we will study only finite-dimensional vector spaces. We shall take the term ‘vector space’ to mean ‘finite-dimensional vector space’.

**2.2 Remark** One reason for sticking to finite-dimensional spaces is so that the representation of a vector with respect to a basis is a finitely-tall vector and we can easily write it. Another reason is that the statement ‘any infinite-dimensional vector space has a basis’ is equivalent to a statement called the Axiom of Choice [Blass 1984] and so covering this would move us far past this book’s scope. (A discussion of the Axiom of Choice is in the Frequently Asked Questions list for sci.math, and another accessible one is [Rucker].)

To prove the main theorem we shall use a technical result, the Exchange Lemma. We first illustrate it with an example.

**2.3 Example** Here is a basis for  $\mathbb{R}^3$  and a vector given as a linear combination of members of that basis.

$$B = \left\langle \begin{pmatrix} 1 \\ 0 \\ 0 \end{pmatrix}, \begin{pmatrix} 1 \\ 1 \\ 0 \end{pmatrix}, \begin{pmatrix} 0 \\ 0 \\ 2 \end{pmatrix} \right\rangle \quad \begin{pmatrix} 1 \\ 2 \\ 0 \end{pmatrix} = (-1) \cdot \begin{pmatrix} 1 \\ 0 \\ 0 \end{pmatrix} + 2 \begin{pmatrix} 1 \\ 1 \\ 0 \end{pmatrix} + 0 \cdot \begin{pmatrix} 0 \\ 0 \\ 2 \end{pmatrix}$$

Two of the basis vectors have non-zero coefficients. Pick one, for instance the first. Replace it with the vector that we’ve expressed as the combination

$$\hat{B} = \left\langle \begin{pmatrix} 1 \\ 2 \\ 0 \end{pmatrix}, \begin{pmatrix} 1 \\ 1 \\ 0 \end{pmatrix}, \begin{pmatrix} 0 \\ 0 \\ 2 \end{pmatrix} \right\rangle$$

and the result is another basis for  $\mathbb{R}^3$ .

**2.4 Lemma (Exchange Lemma)** Assume that  $B = \langle \vec{\beta}_1, \dots, \vec{\beta}_n \rangle$  is a basis for a vector space, and that for the vector  $\vec{v}$  the relationship  $\vec{v} = c_1 \vec{\beta}_1 + c_2 \vec{\beta}_2 + \dots + c_n \vec{\beta}_n$  has  $c_i \neq 0$ . Then exchanging  $\vec{\beta}_i$  for  $\vec{v}$  yields another basis for the space.

**PROOF** Call the outcome of the exchange  $\hat{B} = \langle \vec{\beta}_1, \dots, \vec{\beta}_{i-1}, \vec{v}, \vec{\beta}_{i+1}, \dots, \vec{\beta}_n \rangle$ .

We first show that  $\hat{B}$  is linearly independent. Any relationship  $d_1 \vec{\beta}_1 + \dots + d_i \vec{v} + \dots + d_n \vec{\beta}_n = \vec{0}$  among the members of  $\hat{B}$ , after substitution for  $\vec{v}$ ,

$$d_1 \vec{\beta}_1 + \dots + d_i \cdot (c_1 \vec{\beta}_1 + \dots + c_i \vec{\beta}_i + \dots + c_n \vec{\beta}_n) + \dots + d_n \vec{\beta}_n = \vec{0} \quad (*)$$

gives a linear relationship among the members of  $B$ . The basis  $B$  is linearly independent, so the coefficient  $d_i c_i$  of  $\vec{\beta}_i$  is zero. Because we assumed that  $c_i$  is nonzero,  $d_i = 0$ . Using this in equation (\*) above gives that all of the other  $d$ ’s are also zero. Therefore  $\hat{B}$  is linearly independent.

We finish by showing that  $\hat{B}$  has the same span as  $B$ . Half of this argument, that  $[\hat{B}] \subseteq [B]$ , is easy; we can write any member  $d_1 \vec{\beta}_1 + \dots + d_i \vec{v} + \dots + d_n \vec{\beta}_n$  of  $[\hat{B}]$  as  $d_1 \vec{\beta}_1 + \dots + d_i \cdot (c_1 \vec{\beta}_1 + \dots + c_n \vec{\beta}_n) + \dots + d_n \vec{\beta}_n$ , which is a linear combination of linear combinations of members of  $B$ , and hence is in  $[B]$ . For the  $[B] \subseteq [\hat{B}]$  half of the argument, recall that when  $\vec{v} = c_1 \vec{\beta}_1 + \dots + c_n \vec{\beta}_n$  with  $c_i \neq 0$ , then we can rearrange the equation to  $\vec{\beta}_i = (-c_1/c_i) \vec{\beta}_1 + \dots + (1/c_i) \vec{v} + \dots + (-c_n/c_i) \vec{\beta}_n$ . Now, consider any member  $d_1 \vec{\beta}_1 + \dots + d_i \vec{\beta}_i + \dots + d_n \vec{\beta}_n$  of  $[B]$ , substitute for

$\vec{\beta}_i$  its expression as a linear combination of the members of  $\hat{B}$ , and recognize, as in the first half of this argument, that the result is a linear combination of linear combinations of members of  $\hat{B}$ , and hence is in  $[\hat{B}]$ . QED

**2.5 Theorem** In any finite-dimensional vector space, all bases have the same number of elements.

**PROOF** Fix a vector space with at least one finite basis. Choose, from among all of this space's bases, one  $B = \langle \vec{\beta}_1, \dots, \vec{\beta}_n \rangle$  of minimal size. We will show that any other basis  $D = \langle \vec{\delta}_1, \vec{\delta}_2, \dots \rangle$  also has the same number of members,  $n$ . Because  $B$  has minimal size,  $D$  has no fewer than  $n$  vectors. We will argue that it cannot have more than  $n$  vectors.

The basis  $B$  spans the space and  $\vec{\delta}_1$  is in the space, so  $\vec{\delta}_1$  is a nontrivial linear combination of elements of  $B$ . By the Exchange Lemma, we can swap  $\vec{\delta}_1$  for a vector from  $B$ , resulting in a basis  $B_1$ , where one element is  $\vec{\delta}$  and all of the  $n - 1$  other elements are  $\vec{\beta}$ 's.

The prior paragraph forms the basis step for an induction argument. The inductive step starts with a basis  $B_k$  (for  $1 \leq k < n$ ) containing  $k$  members of  $D$  and  $n - k$  members of  $B$ . We know that  $D$  has at least  $n$  members so there is a  $\vec{\delta}_{k+1}$ . Represent it as a linear combination of elements of  $B_k$ . The key point: in that representation, at least one of the nonzero scalars must be associated with a  $\vec{\beta}_i$  or else that representation would be a nontrivial linear relationship among elements of the linearly independent set  $D$ . Exchange  $\vec{\delta}_{k+1}$  for  $\vec{\beta}_i$  to get a new basis  $B_{k+1}$  with one  $\vec{\delta}$  more and one  $\vec{\beta}$  fewer than the previous basis  $B_k$ .

Repeat the inductive step until no  $\vec{\beta}$ 's remain, so that  $B_n$  contains  $\vec{\delta}_1, \dots, \vec{\delta}_n$ . Now,  $D$  cannot have more than these  $n$  vectors because any  $\vec{\delta}_{n+1}$  that remains would be in the span of  $B_n$  (since it is a basis) and hence would be a linear combination of the other  $\vec{\delta}$ 's, contradicting that  $D$  is linearly independent. QED

**2.6 Definition** The *dimension* of a vector space is the number of vectors in any of its bases.

**2.7 Example** Any basis for  $\mathbb{R}^n$  has  $n$  vectors since the standard basis  $\mathcal{E}_n$  has  $n$  vectors. Thus, this definition generalizes the most familiar use of term, that  $\mathbb{R}^n$  is  $n$ -dimensional.

**2.8 Example** The space  $\mathcal{P}_n$  of polynomials of degree at most  $n$  has dimension  $n + 1$ . We can show this by exhibiting any basis —  $\langle 1, x, \dots, x^n \rangle$  comes to mind — and counting its members.

**2.9 Example** A trivial space is zero-dimensional since its basis is empty.

Again, although we sometimes say 'finite-dimensional' as a reminder, in the rest of this book we assume that all vector spaces are finite-dimensional. An instance of this is that in the next result the word 'space' means 'finite-dimensional vector space'.

**2.10 Corollary** No linearly independent set can have a size greater than the dimension of the enclosing space.

PROOF The above proof never uses that  $D$  spans the space, only that it is linearly independent. QED

**2.11 Example** Recall the subspace diagram from the prior section showing the subspaces of  $\mathbb{R}^3$ . Each subspace shown is described with a minimal spanning set, for which we now have the term ‘basis’. The whole space has a basis with three members, the plane subspaces have bases with two members, the line subspaces have bases with one member, and the trivial subspace has a basis with zero members. When we saw that diagram we could not show that these are  $\mathbb{R}^3$ ’s only subspaces. We can show it now. The prior corollary proves that the only subspaces of  $\mathbb{R}^3$  are either three-, two-, one-, or zero-dimensional. Therefore, the diagram indicates all of the subspaces. There are no subspaces somehow, say, between lines and planes.

**2.12 Corollary** Any linearly independent set can be expanded to make a basis.

PROOF If a linearly independent set is not already a basis then it must not span the space. Adding to the set a vector that is not in the span will preserve linear independence. Keep adding until the resulting set does span the space, which the prior corollary shows will happen after only a finite number of steps. QED

**2.13 Corollary** Any spanning set can be shrunk to a basis.

PROOF Call the spanning set  $S$ . If  $S$  is empty then it is already a basis (the space must be a trivial space). If  $S = \{\vec{0}\}$  then it can be shrunk to the empty basis, thereby making it linearly independent, without changing its span.

Otherwise,  $S$  contains a vector  $\vec{s}_1$  with  $\vec{s}_1 \neq \vec{0}$  and we can form a basis  $B_1 = \langle \vec{s}_1 \rangle$ . If  $[B_1] = [S]$  then we are done. If not then there is a  $\vec{s}_2 \in [S]$  such that  $\vec{s}_2 \notin [B_1]$ . Let  $B_2 = \langle \vec{s}_1, \vec{s}_2 \rangle$ ; if  $[B_2] = [S]$  then we are done.

We can repeat this process until the spans are equal, which must happen in at most finitely many steps. QED

**2.14 Corollary** In an  $n$ -dimensional space, a set composed of  $n$  vectors is linearly independent if and only if it spans the space.

PROOF First we will show that a subset with  $n$  vectors is linearly independent if and only if it is a basis. The ‘if’ is trivially true—bases are linearly independent. ‘Only if’ holds because a linearly independent set can be expanded to a basis, but a basis has  $n$  elements, so this expansion is actually the set that we began with.

To finish, we will show that any subset with  $n$  vectors spans the space if and only if it is a basis. Again, ‘if’ is trivial. ‘Only if’ holds because any spanning set can be shrunk to a basis, but a basis has  $n$  elements and so this shrunken set is just the one we started with. QED

The main result of this subsection, that all of the bases in a finite-dimensional vector space have the same number of elements, is the single most important result in this book because, as Example 2.11 shows, it describes what vector spaces and subspaces there can be. We will see more in the next chapter.

One immediate consequence brings us back to when we considered the two things that could be meant by the term ‘minimal spanning set’. At that point we defined ‘minimal’ as linearly independent but we noted that another reasonable interpretation of the term is that a spanning set is ‘minimal’ when it has the fewest number of elements of any set with the same span. Now that we have shown that all bases have the same number of elements, we know that the two senses of ‘minimal’ are equivalent.

### Exercises

*Assume that all spaces are finite-dimensional unless otherwise stated.*

✓ 2.15 Find a basis for, and the dimension of,  $\mathcal{P}_2$ .

2.16 Find a basis for, and the dimension of, the solution set of this system.

$$\begin{aligned}x_1 - 4x_2 + 3x_3 - x_4 &= 0 \\ 2x_1 - 8x_2 + 6x_3 - 2x_4 &= 0\end{aligned}$$

✓ 2.17 Find a basis for, and the dimension of,  $\mathcal{M}_{2 \times 2}$ , the vector space of  $2 \times 2$  matrices.

2.18 Find the dimension of the vector space of matrices

$$\begin{pmatrix} a & b \\ c & d \end{pmatrix}$$

subject to each condition.

(a)  $a, b, c, d \in \mathbb{R}$

(b)  $a - b + 2c = 0$  and  $d \in \mathbb{R}$

(c)  $a + b + c = 0$ ,  $a + b - c = 0$ , and  $d \in \mathbb{R}$

✓ 2.19 Find the dimension of each.

(a) The space of cubic polynomials  $p(x)$  such that  $p(7) = 0$

(b) The space of cubic polynomials  $p(x)$  such that  $p(7) = 0$  and  $p(5) = 0$

(c) The space of cubic polynomials  $p(x)$  such that  $p(7) = 0$ ,  $p(5) = 0$ , and  $p(3) = 0$

(d) The space of cubic polynomials  $p(x)$  such that  $p(7) = 0$ ,  $p(5) = 0$ ,  $p(3) = 0$ , and  $p(1) = 0$

2.20 What is the dimension of the span of the set  $\{\cos^2 \theta, \sin^2 \theta, \cos 2\theta, \sin 2\theta\}$ ? This span is a subspace of the space of all real-valued functions of one real variable.

2.21 Find the dimension of  $\mathbb{C}^{47}$ , the vector space of 47-tuples of complex numbers.

2.22 What is the dimension of the vector space  $\mathcal{M}_{3 \times 5}$  of  $3 \times 5$  matrices?

✓ 2.23 Show that this is a basis for  $\mathbb{R}^4$ .

$$\left\langle \begin{pmatrix} 1 \\ 0 \\ 0 \\ 0 \end{pmatrix}, \begin{pmatrix} 1 \\ 1 \\ 0 \\ 0 \end{pmatrix}, \begin{pmatrix} 1 \\ 1 \\ 1 \\ 0 \end{pmatrix}, \begin{pmatrix} 1 \\ 1 \\ 1 \\ 1 \end{pmatrix} \right\rangle$$

(We can use the results of this subsection to simplify this job.)

2.24 Refer to Example 2.11.

(a) Sketch a similar subspace diagram for  $\mathcal{P}_2$ .

(b) Sketch one for  $\mathcal{M}_{2 \times 2}$ .

- ✓ 2.25 Where  $S$  is a set, the functions  $f: S \rightarrow \mathbb{R}$  form a vector space under the natural operations: the sum  $f + g$  is the function given by  $f + g(s) = f(s) + g(s)$  and the scalar product is  $r \cdot f(s) = r \cdot f(s)$ . What is the dimension of the space resulting for each domain?
- (a)  $S = \{1\}$     (b)  $S = \{1, 2\}$     (c)  $S = \{1, \dots, n\}$
- 2.26 (See Exercise 25.) Prove that this is an infinite-dimensional space: the set of all functions  $f: \mathbb{R} \rightarrow \mathbb{R}$  under the natural operations.
- 2.27 (See Exercise 25.) What is the dimension of the vector space of functions  $f: S \rightarrow \mathbb{R}$ , under the natural operations, where the domain  $S$  is the empty set?
- 2.28 Show that any set of four vectors in  $\mathbb{R}^2$  is linearly dependent.
- 2.29 Show that  $\langle \vec{\alpha}_1, \vec{\alpha}_2, \vec{\alpha}_3 \rangle \subset \mathbb{R}^3$  is a basis if and only if there is no plane through the origin containing all three vectors.
- 2.30 (a) Prove that any subspace of a finite dimensional space has a basis.  
(b) Prove that any subspace of a finite dimensional space is finite dimensional.
- 2.31 Where is the finiteness of  $B$  used in Theorem 2.5?
- ✓ 2.32 Prove that if  $U$  and  $W$  are both three-dimensional subspaces of  $\mathbb{R}^5$  then  $U \cap W$  is non-trivial. Generalize.
- 2.33 A basis for a space consists of elements of that space. So we are naturally led to how the property 'is a basis' interacts with operations  $\subseteq$  and  $\cap$  and  $\cup$ . (Of course, a basis is actually a sequence in that it is ordered, but there is a natural extension of these operations.)
- (a) Consider first how bases might be related by  $\subseteq$ . Assume that  $U, W$  are subspaces of some vector space and that  $U \subseteq W$ . Can there exist bases  $B_U$  for  $U$  and  $B_W$  for  $W$  such that  $B_U \subseteq B_W$ ? Must such bases exist?
- For any basis  $B_U$  for  $U$ , must there be a basis  $B_W$  for  $W$  such that  $B_U \subseteq B_W$ ?
- For any basis  $B_W$  for  $W$ , must there be a basis  $B_U$  for  $U$  such that  $B_U \subseteq B_W$ ?
- For any bases  $B_U, B_W$  for  $U$  and  $W$ , must  $B_U$  be a subset of  $B_W$ ?
- (b) Is the  $\cap$  of bases a basis? For what space?
- (c) Is the  $\cup$  of bases a basis? For what space?
- (d) What about the complement operation?
- (Hint. Test any conjectures against some subspaces of  $\mathbb{R}^3$ .)
- ✓ 2.34 Consider how 'dimension' interacts with 'subset'. Assume  $U$  and  $W$  are both subspaces of some vector space, and that  $U \subseteq W$ .
- (a) Prove that  $\dim(U) \leq \dim(W)$ .
- (b) Prove that equality of dimension holds if and only if  $U = W$ .
- (c) Show that the prior item does not hold if they are infinite-dimensional.
- ? 2.35 [Wohascum no. 47] For any vector  $\vec{v}$  in  $\mathbb{R}^n$  and any permutation  $\sigma$  of the numbers  $1, 2, \dots, n$  (that is,  $\sigma$  is a rearrangement of those numbers into a new order), define  $\sigma(\vec{v})$  to be the vector whose components are  $v_{\sigma(1)}, v_{\sigma(2)}, \dots$ , and  $v_{\sigma(n)}$  (where  $\sigma(1)$  is the first number in the rearrangement, etc.). Now fix  $\vec{v}$  and let  $V$  be the span of  $\{\sigma(\vec{v}) \mid \sigma \text{ permutes } 1, \dots, n\}$ . What are the possibilities for the dimension of  $V$ ?

### III.3 Vector Spaces and Linear Systems

We will now reconsider linear systems and Gauss' method, aided by the tools and terms of this chapter. We will make three points.

For the first point, recall the first chapter's Linear Combination Lemma and its corollary: if two matrices are related by row operations  $A \rightarrow \cdots \rightarrow B$  then each row of  $B$  is a linear combination of the rows of  $A$ . That is, Gauss' method works by taking linear combinations of rows. Therefore, the right setting in which to study row operations in general, and Gauss' method in particular, is the following vector space.

**3.1 Definition** The *row space* of a matrix is the span of the set of its rows. The *row rank* is the dimension of the row space, the number of linearly independent rows.

**3.2 Example** If

$$A = \begin{pmatrix} 2 & 3 \\ 4 & 6 \end{pmatrix}$$

then  $\text{Rowspace}(A)$  is this subspace of the space of two-component row vectors.

$$\{c_1 \cdot (2 \ 3) + c_2 \cdot (4 \ 6) \mid c_1, c_2 \in \mathbb{R}\}$$

The second is linearly dependent on the first and so we can simplify this description to  $\{c \cdot (2 \ 3) \mid c \in \mathbb{R}\}$ .

**3.3 Lemma** If two matrices  $A$  and  $B$  are related by a row operation

$$A \xrightarrow{\rho_i \leftrightarrow \rho_j} B \quad \text{or} \quad A \xrightarrow{k\rho_i} B \quad \text{or} \quad A \xrightarrow{k\rho_i + \rho_j} B$$

(for  $i \neq j$  and  $k \neq 0$ ) then their row spaces are equal. Hence, row-equivalent matrices have the same row space and therefore the same row rank.

**PROOF** Corollary One.III.2.2 shows that when  $A \rightarrow B$  then each row of  $B$  is a linear combination of the rows of  $A$ . That is, in the above terminology, each row of  $B$  is an element of the row space of  $A$ . Then  $\text{Rowspace}(B) \subseteq \text{Rowspace}(A)$  follows because a member of the set  $\text{Rowspace}(B)$  is a linear combination of the rows of  $B$ , so it is a combination of combinations of the rows of  $A$ , and so by the Linear Combination Lemma is also a member of  $\text{Rowspace}(A)$ .

For the other set containment, recall Lemma One.III.1.5, that row operations are reversible, that  $A \rightarrow B$  if and only if  $B \rightarrow A$ . Then  $\text{Rowspace}(A) \subseteq \text{Rowspace}(B)$  follows as in the previous paragraph. QED

Thus, row operations leave the row space unchanged. But of course, Gauss' method performs the row operations systematically, with the goal of echelon form.



**3.4 Lemma** The nonzero rows of an echelon form matrix make up a linearly independent set.

**PROOF** Lemma One.III.2.4 states that in an echelon form matrix, no nonzero row is a linear combination of the other rows. This restates that result in this chapter's terminology. QED

Thus, in the language of this chapter, Gaussian reduction works by eliminating linear dependences among rows, leaving the span unchanged, until no nontrivial linear relationships remain among the nonzero rows. In short, Gauss' method produces a basis for the row space.

**3.5 Example** From any matrix, we can produce a basis for the row space by performing Gauss' method and taking the nonzero rows of the resulting echelon form matrix. For instance,

$$\begin{pmatrix} 1 & 3 & 1 \\ 1 & 4 & 1 \\ 2 & 0 & 5 \end{pmatrix} \xrightarrow[-2\rho_1+\rho_3]{-\rho_1+\rho_2 \quad 6\rho_2+\rho_3} \begin{pmatrix} 1 & 3 & 1 \\ 0 & 1 & 0 \\ 0 & 0 & 3 \end{pmatrix}$$

produces the basis  $\langle (1 \ 3 \ 1), (0 \ 1 \ 0), (0 \ 0 \ 3) \rangle$  for the row space. This is a basis for the row space of both the starting and ending matrices, since the two row spaces are equal.

Using this technique, we can also find bases for spans not directly involving row vectors.

**3.6 Definition** The *column space* of a matrix is the span of the set of its columns. The *column rank* is the dimension of the column space, the number of linearly independent columns.

Our interest in column spaces stems from our study of linear systems. An example is that this system

$$\begin{aligned} c_1 + 3c_2 + 7c_3 &= d_1 \\ 2c_1 + 3c_2 + 8c_3 &= d_2 \\ c_2 + 2c_3 &= d_3 \\ 4c_1 \quad \quad + 4c_3 &= d_4 \end{aligned}$$

has a solution if and only if the vector of d's is a linear combination of the other column vectors,

$$c_1 \begin{pmatrix} 1 \\ 2 \\ 0 \\ 4 \end{pmatrix} + c_2 \begin{pmatrix} 3 \\ 3 \\ 1 \\ 0 \end{pmatrix} + c_3 \begin{pmatrix} 7 \\ 8 \\ 2 \\ 4 \end{pmatrix} = \begin{pmatrix} d_1 \\ d_2 \\ d_3 \\ d_4 \end{pmatrix}$$

meaning that the vector of d's is in the column space of the matrix of coefficients.

**3.7 Example** Given this matrix,

$$\begin{pmatrix} 1 & 3 & 7 \\ 2 & 3 & 8 \\ 0 & 1 & 2 \\ 4 & 0 & 4 \end{pmatrix}$$

to get a basis for the column space, temporarily turn the columns into rows and reduce.

$$\begin{pmatrix} 1 & 2 & 0 & 4 \\ 3 & 3 & 1 & 0 \\ 7 & 8 & 2 & 4 \end{pmatrix} \xrightarrow[-7\rho_1+\rho_3]{-3\rho_1+\rho_2 \quad -2\rho_2+\rho_3} \begin{pmatrix} 1 & 2 & 0 & 4 \\ 0 & -3 & 1 & -12 \\ 0 & 0 & 0 & 0 \end{pmatrix}$$

Now turn the rows back to columns.

$$\left\langle \begin{pmatrix} 1 \\ 2 \\ 0 \\ 4 \end{pmatrix}, \begin{pmatrix} 0 \\ -3 \\ 1 \\ -12 \end{pmatrix} \right\rangle$$

The result is a basis for the column space of the given matrix.

**3.8 Definition** The *transpose* of a matrix is the result of interchanging the rows and columns of that matrix. That is, column  $j$  of the matrix  $A$  is row  $j$  of  $A^{\text{trans}}$ , and vice versa.

So we can summarize the prior example as “transpose, reduce, and transpose back.”

We can even, at the price of tolerating the as-yet-vague idea of vector spaces being “the same,” use Gauss’ method to find bases for spans in other types of vector spaces.

**3.9 Example** To get a basis for the span of  $\{x^2 + x^4, 2x^2 + 3x^4, -x^2 - 3x^4\}$  in the space  $\mathcal{P}_4$ , think of these three polynomials as “the same” as the row vectors  $(0 \ 0 \ 1 \ 0 \ 1)$ ,  $(0 \ 0 \ 2 \ 0 \ 3)$ , and  $(0 \ 0 \ -1 \ 0 \ -3)$ , apply Gauss’ method

$$\begin{pmatrix} 0 & 0 & 1 & 0 & 1 \\ 0 & 0 & 2 & 0 & 3 \\ 0 & 0 & -1 & 0 & -3 \end{pmatrix} \xrightarrow[\rho_1+\rho_3]{-2\rho_1+\rho_2 \quad 2\rho_2+\rho_3} \begin{pmatrix} 0 & 0 & 1 & 0 & 1 \\ 0 & 0 & 0 & 0 & 1 \\ 0 & 0 & 0 & 0 & 0 \end{pmatrix}$$

and translate back to get the basis  $\langle x^2 + x^4, x^4 \rangle$ . (As mentioned earlier, we will make the phrase “the same” precise at the start of the next chapter.)

Thus, our first point in this subsection is that the tools of this chapter give us a more conceptual understanding of Gaussian reduction.

For the second point of this subsection, observe that row operations on a matrix can change its column space.

$$\begin{pmatrix} 1 & 2 \\ 2 & 4 \end{pmatrix} \xrightarrow{-2\rho_1+\rho_2} \begin{pmatrix} 1 & 2 \\ 0 & 0 \end{pmatrix}$$

The column space of the left-hand matrix contains vectors with a second component that is nonzero but the column space of the right-hand matrix is different because it contains only vectors whose second component is zero. It is this observation that makes next result surprising.

**3.10 Lemma** Row operations do not change the column rank.

**PROOF** Restated, if  $A$  reduces to  $B$  then the column rank of  $B$  equals the column rank of  $A$ .

We will be done if we can show that row operations do not affect linear relationships among columns because the column rank is just the size of the largest set of unrelated columns. That is, we will show that a relationship exists among columns (such as that the fifth column is twice the second plus the fourth) if and only if that relationship exists after the row operation. But this is exactly the first theorem of this book: in a relationship among columns,

$$c_1 \cdot \begin{pmatrix} a_{1,1} \\ a_{2,1} \\ \vdots \\ a_{m,1} \end{pmatrix} + \cdots + c_n \cdot \begin{pmatrix} a_{1,n} \\ a_{2,n} \\ \vdots \\ a_{m,n} \end{pmatrix} = \begin{pmatrix} 0 \\ 0 \\ \vdots \\ 0 \end{pmatrix}$$

row operations leave unchanged the set of solutions  $(c_1, \dots, c_n)$ . QED

Another way, besides the prior result, to state that Gauss' method has something to say about the column space as well as about the row space is with Gauss-Jordan reduction. Recall that it ends with the reduced echelon form of a matrix, as here.

$$\begin{pmatrix} 1 & 3 & 1 & 6 \\ 2 & 6 & 3 & 16 \\ 1 & 3 & 1 & 6 \end{pmatrix} \longrightarrow \cdots \longrightarrow \begin{pmatrix} 1 & 3 & 0 & 2 \\ 0 & 0 & 1 & 4 \\ 0 & 0 & 0 & 0 \end{pmatrix}$$

Consider the row space and the column space of this result. Our first point made above says that a basis for the row space is easy to get: simply collect together all of the rows with leading entries. However, because this is a reduced echelon form matrix, a basis for the column space is just as easy: take the columns containing the leading entries, that is,  $\langle \vec{e}_1, \vec{e}_2 \rangle$ . (Linear independence is obvious. The other columns are in the span of this set, since they all have a third component of zero.) Thus, for a reduced echelon form matrix, we can find bases for the row and column spaces in essentially the same way: by taking the parts of the matrix, the rows or columns, containing the leading entries.

**3.11 Theorem** The row rank and column rank of a matrix are equal.

**PROOF** Bring the matrix to reduced echelon form. At that point, the row rank equals the number of leading entries since that equals the number of nonzero rows. Also at that point, the number of leading entries equals the column rank

because the set of columns containing leading entries consists of some of the  $\vec{e}_i$ 's from a standard basis, and that set is linearly independent and spans the set of columns. Hence, in the reduced echelon form matrix, the row rank equals the column rank, because each equals the number of leading entries.

But Lemma 3.3 and Lemma 3.10 show that the row rank and column rank are not changed by using row operations to get to reduced echelon form. Thus the row rank and the column rank of the original matrix are also equal. QED

**3.12 Definition** The *rank* of a matrix is its row rank or column rank.

So our second point in this subsection is that the column space and row space of a matrix have the same dimension. Our third and final point is that the concepts that we've seen arising naturally in the study of vector spaces are exactly the ones that we have studied with linear systems.

**3.13 Theorem** For linear systems with  $n$  unknowns and with matrix of coefficients  $A$ , the statements

- (1) the rank of  $A$  is  $r$
- (2) the space of solutions of the associated homogeneous system has dimension  $n - r$

are equivalent.

So if the system has at least one particular solution then for the set of solutions, the number of parameters equals  $n - r$ , the number of variables minus the rank of the matrix of coefficients.

**PROOF** The rank of  $A$  is  $r$  if and only if Gaussian reduction on  $A$  ends with  $r$  nonzero rows. That's true if and only if echelon form matrices row equivalent to  $A$  have  $r$ -many leading variables. That in turn holds if and only if there are  $n - r$  free variables. QED

**3.14 Remark** [Munkres] Sometimes that result is mistakenly remembered to say that the general solution of an  $n$  unknown system of  $m$  equations uses  $n - m$  parameters. The number of equations is not the relevant figure, rather, what matters is the number of independent equations (the number of equations in a maximal independent set). Where there are  $r$  independent equations, the general solution involves  $n - r$  parameters.

**3.15 Corollary** Where the matrix  $A$  is  $n \times n$ , the statements

- (1) the rank of  $A$  is  $n$
- (2)  $A$  is nonsingular
- (3) the rows of  $A$  form a linearly independent set
- (4) the columns of  $A$  form a linearly independent set
- (5) any linear system whose matrix of coefficients is  $A$  has one and only one solution

are equivalent.

PROOF Clearly (1)  $\iff$  (2)  $\iff$  (3)  $\iff$  (4). The last, (4)  $\iff$  (5), holds because a set of  $n$  column vectors is linearly independent if and only if it is a basis for  $\mathbb{R}^n$ , but the system

$$c_1 \begin{pmatrix} a_{1,1} \\ a_{2,1} \\ \vdots \\ a_{m,1} \end{pmatrix} + \cdots + c_n \begin{pmatrix} a_{1,n} \\ a_{2,n} \\ \vdots \\ a_{m,n} \end{pmatrix} = \begin{pmatrix} d_1 \\ d_2 \\ \vdots \\ d_m \end{pmatrix}$$

has a unique solution for all choices of  $d_1, \dots, d_m \in \mathbb{R}$  if and only if the vectors of  $a$ 's form a basis. QED

### Exercises

3.16 Transpose each.

(a)  $\begin{pmatrix} 2 & 1 \\ 3 & 1 \end{pmatrix}$    (b)  $\begin{pmatrix} 2 & 1 \\ 1 & 3 \end{pmatrix}$    (c)  $\begin{pmatrix} 1 & 4 & 3 \\ 6 & 7 & 8 \end{pmatrix}$    (d)  $\begin{pmatrix} 0 \\ 0 \\ 0 \end{pmatrix}$

(e)  $\begin{pmatrix} -1 & -2 \end{pmatrix}$

✓ 3.17 Decide if the vector is in the row space of the matrix.

(a)  $\begin{pmatrix} 2 & 1 \\ 3 & 1 \end{pmatrix}, (1 \ 0)$    (b)  $\begin{pmatrix} 0 & 1 & 3 \\ -1 & 0 & 1 \\ -1 & 2 & 7 \end{pmatrix}, (1 \ 1 \ 1)$

✓ 3.18 Decide if the vector is in the column space.

(a)  $\begin{pmatrix} 1 & 1 \\ 1 & 1 \end{pmatrix}, \begin{pmatrix} 1 \\ 3 \end{pmatrix}$    (b)  $\begin{pmatrix} 1 & 3 & 1 \\ 2 & 0 & 4 \\ 1 & -3 & -3 \end{pmatrix}, \begin{pmatrix} 1 \\ 0 \\ 0 \end{pmatrix}$

✓ 3.19 Find a basis for the row space of this matrix.

$$\begin{pmatrix} 2 & 0 & 3 & 4 \\ 0 & 1 & 1 & -1 \\ 3 & 1 & 0 & 2 \\ 1 & 0 & -4 & -1 \end{pmatrix}$$

✓ 3.20 Find the rank of each matrix.

(a)  $\begin{pmatrix} 2 & 1 & 3 \\ 1 & -1 & 2 \\ 1 & 0 & 3 \end{pmatrix}$    (b)  $\begin{pmatrix} 1 & -1 & 2 \\ 3 & -3 & 6 \\ -2 & 2 & -4 \end{pmatrix}$    (c)  $\begin{pmatrix} 1 & 3 & 2 \\ 5 & 1 & 1 \\ 6 & 4 & 3 \end{pmatrix}$

(d)  $\begin{pmatrix} 0 & 0 & 0 \\ 0 & 0 & 0 \\ 0 & 0 & 0 \end{pmatrix}$

✓ 3.21 Find a basis for the span of each set.

(a)  $\{(1 \ 3), (-1 \ 3), (1 \ 4), (2 \ 1)\} \subseteq \mathcal{M}_{1 \times 2}$

(b)  $\left\{ \begin{pmatrix} 1 \\ 2 \\ 1 \end{pmatrix}, \begin{pmatrix} 3 \\ 1 \\ -1 \end{pmatrix}, \begin{pmatrix} 1 \\ -3 \\ -3 \end{pmatrix} \right\} \subseteq \mathbb{R}^3$

(c)  $\{1 + x, 1 - x^2, 3 + 2x - x^2\} \subseteq \mathcal{P}_3$

(d)  $\left\{ \begin{pmatrix} 1 & 0 & 1 \\ 3 & 1 & -1 \end{pmatrix}, \begin{pmatrix} 1 & 0 & 3 \\ 2 & 1 & 4 \end{pmatrix}, \begin{pmatrix} -1 & 0 & -5 \\ -1 & -1 & -9 \end{pmatrix} \right\} \subseteq \mathcal{M}_{2 \times 3}$

3.22 Which matrices have rank zero? Rank one?

- ✓ 3.23 Given  $a, b, c \in \mathbb{R}$ , what choice of  $d$  will cause this matrix to have the rank of one?

$$\begin{pmatrix} a & b \\ c & d \end{pmatrix}$$

- 3.24 Find the column rank of this matrix.

$$\begin{pmatrix} 1 & 3 & -1 & 5 & 0 & 4 \\ 2 & 0 & 1 & 0 & 4 & 1 \end{pmatrix}$$

- 3.25 Show that a linear system with at least one solution has at most one solution if and only if the matrix of coefficients has rank equal to the number of its columns.
- ✓ 3.26 If a matrix is  $5 \times 9$ , which set must be dependent, its set of rows or its set of columns?
- 3.27 Give an example to show that, despite that they have the same dimension, the row space and column space of a matrix need not be equal. Are they ever equal?
- 3.28 Show that the set  $\{(1, -1, 2, -3), (1, 1, 2, 0), (3, -1, 6, -6)\}$  does not have the same span as  $\{(1, 0, 1, 0), (0, 2, 0, 3)\}$ . What, by the way, is the vector space?
- ✓ 3.29 Show that this set of column vectors

$$\left\{ \begin{pmatrix} d_1 \\ d_2 \\ d_3 \end{pmatrix} \mid \text{there are } x, y, \text{ and } z \text{ such that: } \begin{array}{l} 3x + 2y + 4z = d_1 \\ x - z = d_2 \\ 2x + 2y + 5z = d_3 \end{array} \right\}$$

is a subspace of  $\mathbb{R}^3$ . Find a basis.

- 3.30 Show that the transpose operation is *linear*:

$$(rA + sB)^{\text{trans}} = rA^{\text{trans}} + sB^{\text{trans}}$$

for  $r, s \in \mathbb{R}$  and  $A, B \in \mathcal{M}_{m \times n}$ .

- ✓ 3.31 In this subsection we have shown that Gaussian reduction finds a basis for the row space.
- Show that this basis is not unique—different reductions may yield different bases.
  - Produce matrices with equal row spaces but unequal numbers of rows.
  - Prove that two matrices have equal row spaces if and only if after Gauss-Jordan reduction they have the same nonzero rows.
- 3.32 Why is there not a problem with Remark 3.14 in the case that  $r$  is bigger than  $n$ ?
- 3.33 Show that the row rank of an  $m \times n$  matrix is at most  $m$ . Is there a better bound?
- ✓ 3.34 Show that the rank of a matrix equals the rank of its transpose.
- 3.35 True or false: the column space of a matrix equals the row space of its transpose.
- ✓ 3.36 We have seen that a row operation may change the column space. Must it?
- 3.37 Prove that a linear system has a solution if and only if that system's matrix of coefficients has the same rank as its augmented matrix.
- 3.38 An  $m \times n$  matrix has *full row rank* if its row rank is  $m$ , and it has *full column rank* if its column rank is  $n$ .
- Show that a matrix can have both full row rank and full column rank only if it is square.
  - Prove that the linear system with matrix of coefficients  $A$  has a solution for any  $d_1, \dots, d_n$ 's on the right side if and only if  $A$  has full row rank.
  - Prove that a homogeneous system has a unique solution if and only if its matrix of coefficients  $A$  has full column rank.

- (d) Prove that the statement “if a system with matrix of coefficients  $A$  has any solution then it has a unique solution” holds if and only if  $A$  has full column rank.
- 3.39 How would the conclusion of Lemma 3.3 change if Gauss’ method were changed to allow multiplying a row by zero?
- ✓ 3.40 What is the relationship between  $\text{rank}(A)$  and  $\text{rank}(-A)$ ? Between  $\text{rank}(A)$  and  $\text{rank}(kA)$ ? What, if any, is the relationship between  $\text{rank}(A)$ ,  $\text{rank}(B)$ , and  $\text{rank}(A + B)$ ?

### III.4 Combining Subspaces

*This subsection is optional. It is required only for the last sections of Chapter Three and Chapter Five and for occasional exercises, and can be passed over without loss of continuity.*

One way to understand something is to see how to build it from component parts. For instance, we sometimes think of  $\mathbb{R}^3$  as in some way put together from the  $x$ -axis, the  $y$ -axis, and  $z$ -axis. In this subsection we will describe how to decompose a vector space into a combination of some of its subspaces. In developing this idea of subspace combination, we will keep the  $\mathbb{R}^3$  example in mind as a prototype.

Subspaces are subsets and sets combine via union. But taking the combination operation for subspaces to be the simple union operation isn’t what we want. For instance, the union of the  $x$ -axis, the  $y$ -axis, and  $z$ -axis is not all of  $\mathbb{R}^3$  and in fact this union of subspaces is not a subspace because it is not closed under addition:

$$\begin{pmatrix} 1 \\ 0 \\ 0 \end{pmatrix} + \begin{pmatrix} 0 \\ 1 \\ 0 \end{pmatrix} + \begin{pmatrix} 0 \\ 0 \\ 1 \end{pmatrix} = \begin{pmatrix} 1 \\ 1 \\ 1 \end{pmatrix}$$

is in none of the three axes and hence is not in the union. Therefore, in addition to the members of the subspaces we must at least also include all of the linear combinations.

**4.1 Definition** Where  $W_1, \dots, W_k$  are subspaces of a vector space, their *sum* is the span of their union  $W_1 + W_2 + \dots + W_k = [W_1 \cup W_2 \cup \dots \cup W_k]$ .

Writing ‘+’ here fits with the practice of using this symbol for a natural accumulation operation.

**4.2 Example** The  $\mathbb{R}^3$  prototype works with this. Any vector  $\vec{w} \in \mathbb{R}^3$  is a linear combination  $c_1\vec{v}_1 + c_2\vec{v}_2 + c_3\vec{v}_3$  where  $\vec{v}_1$  is a member of the  $x$ -axis, etc., in this way

$$\begin{pmatrix} w_1 \\ w_2 \\ w_3 \end{pmatrix} = 1 \cdot \begin{pmatrix} w_1 \\ 0 \\ 0 \end{pmatrix} + 1 \cdot \begin{pmatrix} 0 \\ w_2 \\ 0 \end{pmatrix} + 1 \cdot \begin{pmatrix} 0 \\ 0 \\ w_3 \end{pmatrix}$$

and so  $\mathbb{R}^3 = x\text{-axis} + y\text{-axis} + z\text{-axis}$ .

**4.3 Example** A sum of subspaces can be less than the entire space. Inside of  $\mathcal{P}_4$ , let  $L$  be the subspace of linear polynomials  $\{a + bx \mid a, b \in \mathbb{R}\}$  and let  $C$  be the subspace of purely-cubic polynomials  $\{cx^3 \mid c \in \mathbb{R}\}$ . Then  $L + C$  is not all of  $\mathcal{P}_4$ . Instead,  $L + C = \{a + bx + cx^3 \mid a, b, c \in \mathbb{R}\}$ .

**4.4 Example** A space can be described as a combination of subspaces in more than one way. Besides the decomposition  $\mathbb{R}^3 = x\text{-axis} + y\text{-axis} + z\text{-axis}$ , we can also write  $\mathbb{R}^3 = xy\text{-plane} + yz\text{-plane}$ . To check this, note that any  $\vec{w} \in \mathbb{R}^3$  can be written as a linear combination of a member of the  $xy$ -plane and a member of the  $yz$ -plane; here are two such combinations.

$$\begin{pmatrix} w_1 \\ w_2 \\ w_3 \end{pmatrix} = 1 \cdot \begin{pmatrix} w_1 \\ w_2 \\ 0 \end{pmatrix} + 1 \cdot \begin{pmatrix} 0 \\ 0 \\ w_3 \end{pmatrix} \quad \begin{pmatrix} w_1 \\ w_2 \\ w_3 \end{pmatrix} = 1 \cdot \begin{pmatrix} w_1 \\ w_2/2 \\ 0 \end{pmatrix} + 1 \cdot \begin{pmatrix} 0 \\ w_2/2 \\ w_3 \end{pmatrix}$$

The above definition gives one way in which we can think of a space as a combination of some of its parts. However, the prior example shows that there is at least one interesting property of our benchmark model that is not captured by the definition of the sum of subspaces. In the familiar decomposition of  $\mathbb{R}^3$ , we often speak of a vector's 'x part' or 'y part' or 'z part'. That is, in our prototype each vector has a unique decomposition into parts that come from the parts making up the whole space. But in the decomposition used in Example 4.4, we cannot refer to the "xy part" of a vector — these three sums

$$\begin{pmatrix} 1 \\ 2 \\ 3 \end{pmatrix} = \begin{pmatrix} 1 \\ 2 \\ 0 \end{pmatrix} + \begin{pmatrix} 0 \\ 0 \\ 3 \end{pmatrix} = \begin{pmatrix} 1 \\ 0 \\ 0 \end{pmatrix} + \begin{pmatrix} 0 \\ 2 \\ 3 \end{pmatrix} = \begin{pmatrix} 1 \\ 1 \\ 0 \end{pmatrix} + \begin{pmatrix} 0 \\ 1 \\ 3 \end{pmatrix}$$

all describe the vector as comprised of something from the first plane plus something from the second plane, but the "xy part" is different in each.

That is, when we consider how  $\mathbb{R}^3$  is put together from the three axes we might mean "in such a way that every vector has at least one decomposition," and that leads to the definition above. But if we take it to mean "in such a way that every vector has one and only one decomposition" then we need another condition on combinations. To see what this condition is, recall that vectors are uniquely represented in terms of a basis. We can use this to break a space into a sum of subspaces such that any vector in the space breaks uniquely into a sum of members of those subspaces.

**4.5 Example** Consider  $\mathbb{R}^3$  with its standard basis  $\mathcal{E}_3 = \langle \vec{e}_1, \vec{e}_2, \vec{e}_3 \rangle$ . The subspace with the basis  $B_1 = \langle \vec{e}_1 \rangle$  is the  $x$ -axis. The subspace with the basis  $B_2 = \langle \vec{e}_2 \rangle$  is the  $y$ -axis. The subspace with the basis  $B_3 = \langle \vec{e}_3 \rangle$  is the  $z$ -axis. The fact that any member of  $\mathbb{R}^3$  is expressible as a sum of vectors from these subspaces

$$\begin{pmatrix} x \\ y \\ z \end{pmatrix} = \begin{pmatrix} x \\ 0 \\ 0 \end{pmatrix} + \begin{pmatrix} 0 \\ y \\ 0 \end{pmatrix} + \begin{pmatrix} 0 \\ 0 \\ z \end{pmatrix}$$



is a reflection of the fact that  $\mathcal{E}_3$  spans the space—this equation

$$\begin{pmatrix} x \\ y \\ z \end{pmatrix} = c_1 \begin{pmatrix} 1 \\ 0 \\ 0 \end{pmatrix} + c_2 \begin{pmatrix} 0 \\ 1 \\ 0 \end{pmatrix} + c_3 \begin{pmatrix} 0 \\ 0 \\ 1 \end{pmatrix}$$

has a solution for any  $x, y, z \in \mathbb{R}$ . And, the fact that each such expression is unique reflects that fact that  $\mathcal{E}_3$  is linearly independent—any equation like the one above has a unique solution.

**4.6 Example** We don't have to take the basis vectors one at a time, the same idea works if we conglomerate them into larger sequences. Consider again the space  $\mathbb{R}^3$  and the vectors from the standard basis  $\mathcal{E}_3$ . The subspace with the basis  $B_1 = \langle \vec{e}_1, \vec{e}_3 \rangle$  is the  $xz$ -plane. The subspace with the basis  $B_2 = \langle \vec{e}_2 \rangle$  is the  $y$ -axis. As in the prior example, the fact that any member of the space is a sum of members of the two subspaces in one and only one way

$$\begin{pmatrix} x \\ y \\ z \end{pmatrix} = \begin{pmatrix} x \\ 0 \\ z \end{pmatrix} + \begin{pmatrix} 0 \\ y \\ 0 \end{pmatrix}$$

is a reflection of the fact that these vectors form a basis—this system

$$\begin{pmatrix} x \\ y \\ z \end{pmatrix} = (c_1 \begin{pmatrix} 1 \\ 0 \\ 0 \end{pmatrix} + c_3 \begin{pmatrix} 0 \\ 0 \\ 1 \end{pmatrix}) + c_2 \begin{pmatrix} 0 \\ 1 \\ 0 \end{pmatrix}$$

has one and only one solution for any  $x, y, z \in \mathbb{R}$ .

These examples illustrate a natural way to decompose a space into a sum of subspaces in such a way that each vector decomposes uniquely into a sum of vectors from the parts.

**4.7 Definition** The *concatenation* of the sequences  $B_1 = \langle \vec{\beta}_{1,1}, \dots, \vec{\beta}_{1,n_1} \rangle, \dots, B_k = \langle \vec{\beta}_{k,1}, \dots, \vec{\beta}_{k,n_k} \rangle$  adjoins them into a single sequence.

$$B_1 \widehat{\ } B_2 \widehat{\ } \dots \widehat{\ } B_k = \langle \vec{\beta}_{1,1}, \dots, \vec{\beta}_{1,n_1}, \vec{\beta}_{2,1}, \dots, \vec{\beta}_{k,n_k} \rangle$$

**4.8 Lemma** Let  $V$  be a vector space that is the sum of some of its subspaces  $V = W_1 + \dots + W_k$ . Let  $B_1, \dots, B_k$  be bases for these subspaces. The following are equivalent.

- (1) The expression of any  $\vec{v} \in V$  as a combination  $\vec{v} = \vec{w}_1 + \dots + \vec{w}_k$  with  $\vec{w}_i \in W_i$  is unique.
- (2) The concatenation  $B_1 \widehat{\ } \dots \widehat{\ } B_k$  is a basis for  $V$ .
- (3) The nonzero members of  $\{\vec{w}_1, \dots, \vec{w}_k\}$ , with  $\vec{w}_i \in W_i$ , form a linearly independent set.

PROOF We will show that (1)  $\implies$  (2), that (2)  $\implies$  (3), and finally that (3)  $\implies$  (1). For these arguments, observe that we can pass from a combination of  $\vec{w}$ 's to a combination of  $\vec{\beta}$ 's

$$\begin{aligned} & d_1 \vec{w}_1 + \cdots + d_k \vec{w}_k \\ &= d_1 (c_{1,1} \vec{\beta}_{1,1} + \cdots + c_{1,n_1} \vec{\beta}_{1,n_1}) + \cdots + d_k (c_{k,1} \vec{\beta}_{k,1} + \cdots + c_{k,n_k} \vec{\beta}_{k,n_k}) \\ &= d_1 c_{1,1} \cdot \vec{\beta}_{1,1} + \cdots + d_k c_{k,n_k} \cdot \vec{\beta}_{k,n_k} \end{aligned} \tag{*}$$

and vice versa (we can move from the bottom to the top by taking each  $d_i$  to be 1).

For (1)  $\implies$  (2), assume that all decompositions are unique. We will show that  $B_1 \widehat{\phantom{B}} \cdots \widehat{\phantom{B}} B_k$  spans the space and is linearly independent. It spans the space because the assumption that  $V = W_1 + \cdots + W_k$  means that every  $\vec{v}$  can be expressed as  $\vec{v} = \vec{w}_1 + \cdots + \vec{w}_k$ , which translates by equation (\*) to an expression of  $\vec{v}$  as a linear combination of the  $\vec{\beta}$ 's from the concatenation. For linear independence, consider this linear relationship.

$$\vec{0} = c_{1,1} \vec{\beta}_{1,1} + \cdots + c_{k,n_k} \vec{\beta}_{k,n_k}$$

Regroup as in (\*) (that is, move from bottom to top) to get the decomposition  $\vec{0} = \vec{w}_1 + \cdots + \vec{w}_k$ . Because the zero vector obviously has the decomposition  $\vec{0} = \vec{0} + \cdots + \vec{0}$ , the assumption that decompositions are unique shows that each  $\vec{w}_i$  is the zero vector. This means that  $c_{i,1} \vec{\beta}_{i,1} + \cdots + c_{i,n_i} \vec{\beta}_{i,n_i} = \vec{0}$ . Thus, since each  $B_i$  is a basis, we have the desired conclusion that all of the  $c$ 's are zero.

For (2)  $\implies$  (3), assume that  $B_1 \widehat{\phantom{B}} \cdots \widehat{\phantom{B}} B_k$  is a basis for the space. Consider a linear relationship among nonzero vectors from different  $W_i$ 's,

$$\vec{0} = \cdots + d_i \vec{w}_i + \cdots$$

in order to show that it is trivial. (The relationship is written in this way because we are considering a combination of nonzero vectors from only some of the  $W_i$ 's; for instance, there might not be a  $\vec{w}_1$  in this combination.) As in (\*),  $\vec{0} = \cdots + d_i (c_{i,1} \vec{\beta}_{i,1} + \cdots + c_{i,n_i} \vec{\beta}_{i,n_i}) + \cdots = \cdots + d_i c_{i,1} \cdot \vec{\beta}_{i,1} + \cdots + d_i c_{i,n_i} \cdot \vec{\beta}_{i,n_i} + \cdots$  and the linear independence of  $B_1 \widehat{\phantom{B}} \cdots \widehat{\phantom{B}} B_k$  gives that each coefficient  $d_i c_{i,j}$  is zero. Now,  $\vec{w}_i$  is a nonzero vector, so at least one of the  $c_{i,j}$ 's is not zero, and thus  $d_i$  is zero. This holds for each  $d_i$ , and therefore the linear relationship is trivial.

Finally, for (3)  $\implies$  (1), assume that, among nonzero vectors from different  $W_i$ 's, any linear relationship is trivial. Consider two decompositions of a vector  $\vec{v} = \vec{w}_1 + \cdots + \vec{w}_k$  and  $\vec{v} = \vec{u}_1 + \cdots + \vec{u}_k$  in order to show that the two are the same. We have

$$\vec{0} = (\vec{w}_1 + \cdots + \vec{w}_k) - (\vec{u}_1 + \cdots + \vec{u}_k) = (\vec{w}_1 - \vec{u}_1) + \cdots + (\vec{w}_k - \vec{u}_k)$$

which violates the assumption unless each  $\vec{w}_i - \vec{u}_i$  is the zero vector. Hence, decompositions are unique. QED

**4.9 Definition** A collection of subspaces  $\{W_1, \dots, W_k\}$  is *independent* if no nonzero vector from any  $W_i$  is a linear combination of vectors from the other subspaces  $W_1, \dots, W_{i-1}, W_{i+1}, \dots, W_k$ .

**4.10 Definition** A vector space  $V$  is the *direct sum* (or *internal direct sum*) of its subspaces  $W_1, \dots, W_k$  if  $V = W_1 + W_2 + \dots + W_k$  and the collection  $\{W_1, \dots, W_k\}$  is independent. We write  $V = W_1 \oplus W_2 \oplus \dots \oplus W_k$ .

**4.11 Example** Our prototype works:  $\mathbb{R}^3 = x\text{-axis} \oplus y\text{-axis} \oplus z\text{-axis}$ .

**4.12 Example** The space of  $2 \times 2$  matrices is this direct sum.

$$\left\{ \begin{pmatrix} a & 0 \\ 0 & d \end{pmatrix} \mid a, d \in \mathbb{R} \right\} \oplus \left\{ \begin{pmatrix} 0 & b \\ 0 & 0 \end{pmatrix} \mid b \in \mathbb{R} \right\} \oplus \left\{ \begin{pmatrix} 0 & 0 \\ c & 0 \end{pmatrix} \mid c \in \mathbb{R} \right\}$$

It is the direct sum of subspaces in many other ways as well; direct sum decompositions are not unique.

**4.13 Corollary** The dimension of a direct sum is the sum of the dimensions of its summands.

**PROOF** In Lemma 4.8, the number of basis vectors in the concatenation equals the sum of the number of vectors in the sub-bases that make up the concatenation. QED

The special case of two subspaces is worth mentioning separately.

**4.14 Definition** When a vector space is the direct sum of two of its subspaces then they are *complements*.

**4.15 Lemma** A vector space  $V$  is the direct sum of two of its subspaces  $W_1$  and  $W_2$  if and only if it is the sum of the two  $V = W_1 + W_2$  and their intersection is trivial  $W_1 \cap W_2 = \{\vec{0}\}$ .

**PROOF** Suppose first that  $V = W_1 \oplus W_2$ . By definition,  $V$  is the sum of the two. To show that they have a trivial intersection, let  $\vec{v}$  be a vector from  $W_1 \cap W_2$  and consider the equation  $\vec{v} = \vec{v}$ . On the left side of that equation is a member of  $W_1$ , and on the right side is a member of  $W_2$ , which we can think of as a linear combination of members (of only one member) of  $W_2$ . But the spaces are independent so the only way a member of  $W_1$  can be a linear combination of members of  $W_2$  is if it is the zero vector  $\vec{v} = \vec{0}$ .

For the other direction, suppose that  $V$  is the sum of two spaces with a trivial intersection. To show that  $V$  is a direct sum of the two, we need only show that the spaces are independent — no nonzero member of the first is expressible as a linear combination of members of the second, and vice versa. This is true because any relationship  $\vec{w}_1 = c_1 \vec{w}_{2,1} + \dots + d_k \vec{w}_{2,k}$  (with  $\vec{w}_1 \in W_1$  and  $\vec{w}_{2,j} \in W_2$  for

all  $j$ ) shows that the vector on the left is also in  $W_2$ , since the right side is a combination of members of  $W_2$ . The intersection of these two spaces is trivial, so  $\vec{w}_1 = \vec{0}$ . The same argument works for any  $\vec{w}_2$ . QED

**4.16 Example** In the space  $\mathbb{R}^2$ , the  $x$ -axis and the  $y$ -axis are complements, that is,  $\mathbb{R}^2 = x\text{-axis} \oplus y\text{-axis}$ . A space can have more than one pair of complementary subspaces; another pair here are the subspaces consisting of the lines  $y = x$  and  $y = 2x$ .

**4.17 Example** In the space  $F = \{a \cos \theta + b \sin \theta \mid a, b \in \mathbb{R}\}$ , the subspaces  $W_1 = \{a \cos \theta \mid a \in \mathbb{R}\}$  and  $W_2 = \{b \sin \theta \mid b \in \mathbb{R}\}$  are complements. In addition to the fact that a space like  $F$  can have more than one pair of complementary subspaces, inside of the space a single subspace like  $W_1$  can have more than one complement — another complement of  $W_1$  is  $W_3 = \{b \sin \theta + b \cos \theta \mid b \in \mathbb{R}\}$ .

**4.18 Example** In  $\mathbb{R}^3$ , the  $xy$ -plane and the  $yz$ -planes are not complements, which is the point of the discussion following Example 4.4. One complement of the  $xy$ -plane is the  $z$ -axis. A complement of the  $yz$ -plane is the line through  $(1, 1, 1)$ .

Following Lemma 4.15, here is a natural question: is the simple sum  $V = W_1 + \cdots + W_k$  also a direct sum if and only if the intersection of the subspaces is trivial?

**4.19 Example** If there are more than two subspaces then having a trivial intersection is not enough to guarantee unique decomposition (i.e., is not enough to ensure that the spaces are independent). In  $\mathbb{R}^3$ , let  $W_1$  be the  $x$ -axis, let  $W_2$  be the  $y$ -axis, and let  $W_3$  be this.

$$W_3 = \left\{ \begin{pmatrix} q \\ q \\ r \end{pmatrix} \mid q, r \in \mathbb{R} \right\}$$

The check that  $\mathbb{R}^3 = W_1 + W_2 + W_3$  is easy. The intersection  $W_1 \cap W_2 \cap W_3$  is trivial, but decompositions aren't unique.

$$\begin{pmatrix} x \\ y \\ z \end{pmatrix} = \begin{pmatrix} 0 \\ 0 \\ 0 \end{pmatrix} + \begin{pmatrix} 0 \\ y - x \\ 0 \end{pmatrix} + \begin{pmatrix} x \\ x \\ z \end{pmatrix} = \begin{pmatrix} x - y \\ 0 \\ 0 \end{pmatrix} + \begin{pmatrix} 0 \\ 0 \\ 0 \end{pmatrix} + \begin{pmatrix} y \\ y \\ z \end{pmatrix}$$

(This example also shows that this requirement is also not enough: that all pairwise intersections of the subspaces be trivial. See Exercise 30.)

In this subsection we have seen two ways to regard a space as built up from component parts. Both are useful; in particular we will use the direct sum definition to do the Jordan Form construction at the end of the fifth chapter.

### Exercises

✓ **4.20** Decide if  $\mathbb{R}^2$  is the direct sum of each  $W_1$  and  $W_2$ .

(a)  $W_1 = \left\{ \begin{pmatrix} x \\ 0 \end{pmatrix} \mid x \in \mathbb{R} \right\}$ ,  $W_2 = \left\{ \begin{pmatrix} x \\ x \end{pmatrix} \mid x \in \mathbb{R} \right\}$

$$(b) W_1 = \left\{ \begin{pmatrix} s \\ s \end{pmatrix} \mid s \in \mathbb{R} \right\}, W_2 = \left\{ \begin{pmatrix} s \\ 1.1s \end{pmatrix} \mid s \in \mathbb{R} \right\}$$

$$(c) W_1 = \mathbb{R}^2, W_2 = \{ \vec{0} \}$$

$$(d) W_1 = W_2 = \left\{ \begin{pmatrix} t \\ t \end{pmatrix} \mid t \in \mathbb{R} \right\}$$

$$(e) W_1 = \left\{ \begin{pmatrix} 1 \\ 0 \end{pmatrix} + \begin{pmatrix} x \\ 0 \end{pmatrix} \mid x \in \mathbb{R} \right\}, W_2 = \left\{ \begin{pmatrix} -1 \\ 0 \end{pmatrix} + \begin{pmatrix} 0 \\ y \end{pmatrix} \mid y \in \mathbb{R} \right\}$$

✓ 4.21 Show that  $\mathbb{R}^3$  is the direct sum of the  $xy$ -plane with each of these.

(a) the  $z$ -axis

(b) the line

$$\left\{ \begin{pmatrix} z \\ z \\ z \end{pmatrix} \mid z \in \mathbb{R} \right\}$$

4.22 Is  $\mathcal{P}_2$  the direct sum of  $\{a + bx^2 \mid a, b \in \mathbb{R}\}$  and  $\{cx \mid c \in \mathbb{R}\}$ ?

✓ 4.23 In  $\mathcal{P}_n$ , the *even* polynomials are the members of this set

$$\mathcal{E} = \{p \in \mathcal{P}_n \mid p(-x) = p(x) \text{ for all } x\}$$

and the *odd* polynomials are the members of this set.

$$\mathcal{O} = \{p \in \mathcal{P}_n \mid p(-x) = -p(x) \text{ for all } x\}$$

Show that these are complementary subspaces.

4.24 Which of these subspaces of  $\mathbb{R}^3$

$W_1$ : the  $x$ -axis,  $W_2$ : the  $y$ -axis,  $W_3$ : the  $z$ -axis,

$W_4$ : the plane  $x + y + z = 0$ ,  $W_5$ : the  $yz$ -plane

can be combined to

(a) sum to  $\mathbb{R}^3$ ? (b) direct sum to  $\mathbb{R}^3$ ?

✓ 4.25 Show that  $\mathcal{P}_n = \{a_0 \mid a_0 \in \mathbb{R}\} \oplus \dots \oplus \{a_n x^n \mid a_n \in \mathbb{R}\}$ .

4.26 What is  $W_1 + W_2$  if  $W_1 \subseteq W_2$ ?

4.27 Does Example 4.5 generalize? That is, is this true or false: if a vector space  $V$  has a basis  $\{\vec{\beta}_1, \dots, \vec{\beta}_n\}$  then it is the direct sum of the spans of the one-dimensional subspaces  $V = \{[\vec{\beta}_1]\} \oplus \dots \oplus \{[\vec{\beta}_n]\}$ ?

4.28 Can  $\mathbb{R}^4$  be decomposed as a direct sum in two different ways? Can  $\mathbb{R}^1$ ?

4.29 This exercise makes the notation of writing '+' between sets more natural. Prove that, where  $W_1, \dots, W_k$  are subspaces of a vector space,

$$W_1 + \dots + W_k = \{ \vec{w}_1 + \vec{w}_2 + \dots + \vec{w}_k \mid \vec{w}_1 \in W_1, \dots, \vec{w}_k \in W_k \},$$

and so the sum of subspaces is the subspace of all sums.

4.30 (Refer to Example 4.19. This exercise shows that the requirement that pairwise intersections be trivial is genuinely stronger than the requirement only that the intersection of all of the subspaces be trivial.) Give a vector space and three subspaces  $W_1, W_2$ , and  $W_3$  such that the space is the sum of the subspaces, the intersection of all three subspaces  $W_1 \cap W_2 \cap W_3$  is trivial, but the pairwise intersections  $W_1 \cap W_2$ ,  $W_1 \cap W_3$ , and  $W_2 \cap W_3$  are nontrivial.

✓ 4.31 Prove that if  $V = W_1 \oplus \dots \oplus W_k$  then  $W_i \cap W_j$  is trivial whenever  $i \neq j$ . This shows that the first half of the proof of Lemma 4.15 extends to the case of more than two subspaces. (Example 4.19 shows that this implication does not reverse; the other half does not extend.)

4.32 Recall that no linearly independent set contains the zero vector. Can an independent set of subspaces contain the trivial subspace?

✓ 4.33 Does every subspace have a complement?

- ✓ 4.34 Let  $W_1, W_2$  be subspaces of a vector space.
- Assume that the set  $S_1$  spans  $W_1$ , and that the set  $S_2$  spans  $W_2$ . Can  $S_1 \cup S_2$  span  $W_1 + W_2$ ? Must it?
  - Assume that  $S_1$  is a linearly independent subset of  $W_1$  and that  $S_2$  is a linearly independent subset of  $W_2$ . Can  $S_1 \cup S_2$  be a linearly independent subset of  $W_1 + W_2$ ? Must it?

4.35 When we decompose a vector space as a direct sum, the dimensions of the subspaces add to the dimension of the space. The situation with a space that is given as the sum of its subspaces is not as simple. This exercise considers the two-subspace special case.

- (a) For these subspaces of  $\mathcal{M}_{2 \times 2}$  find  $W_1 \cap W_2$ ,  $\dim(W_1 \cap W_2)$ ,  $W_1 + W_2$ , and  $\dim(W_1 + W_2)$ .

$$W_1 = \left\{ \begin{pmatrix} 0 & 0 \\ c & d \end{pmatrix} \mid c, d \in \mathbb{R} \right\} \quad W_2 = \left\{ \begin{pmatrix} 0 & b \\ c & 0 \end{pmatrix} \mid b, c \in \mathbb{R} \right\}$$

- (b) Suppose that  $U$  and  $W$  are subspaces of a vector space. Suppose that the sequence  $\langle \vec{\beta}_1, \dots, \vec{\beta}_k \rangle$  is a basis for  $U \cap W$ . Finally, suppose that the prior sequence has been expanded to give a sequence  $\langle \vec{\mu}_1, \dots, \vec{\mu}_j, \vec{\beta}_1, \dots, \vec{\beta}_k \rangle$  that is a basis for  $U$ , and a sequence  $\langle \vec{\beta}_1, \dots, \vec{\beta}_k, \vec{\omega}_1, \dots, \vec{\omega}_p \rangle$  that is a basis for  $W$ . Prove that this sequence

$$\langle \vec{\mu}_1, \dots, \vec{\mu}_j, \vec{\beta}_1, \dots, \vec{\beta}_k, \vec{\omega}_1, \dots, \vec{\omega}_p \rangle$$

is a basis for the sum  $U + W$ .

- (c) Conclude that  $\dim(U + W) = \dim(U) + \dim(W) - \dim(U \cap W)$ .
- (d) Let  $W_1$  and  $W_2$  be eight-dimensional subspaces of a ten-dimensional space. List all values possible for  $\dim(W_1 \cap W_2)$ .

4.36 Let  $V = W_1 \oplus \dots \oplus W_k$  and for each index  $i$  suppose that  $S_i$  is a linearly independent subset of  $W_i$ . Prove that the union of the  $S_i$ 's is linearly independent.

4.37 A matrix is *symmetric* if for each pair of indices  $i$  and  $j$ , the  $i, j$  entry equals the  $j, i$  entry. A matrix is *antisymmetric* if each  $i, j$  entry is the negative of the  $j, i$  entry.

- Give a symmetric  $2 \times 2$  matrix and an antisymmetric  $2 \times 2$  matrix. (*Remark.* For the second one, be careful about the entries on the diagonal.)
- What is the relationship between a square symmetric matrix and its transpose? Between a square antisymmetric matrix and its transpose?
- Show that  $\mathcal{M}_{n \times n}$  is the direct sum of the space of symmetric matrices and the space of antisymmetric matrices.

4.38 Let  $W_1, W_2, W_3$  be subspaces of a vector space. Prove that  $(W_1 \cap W_2) + (W_1 \cap W_3) \subseteq W_1 \cap (W_2 + W_3)$ . Does the inclusion reverse?

4.39 The example of the  $x$ -axis and the  $y$ -axis in  $\mathbb{R}^2$  shows that  $W_1 \oplus W_2 = V$  does not imply that  $W_1 \cup W_2 = V$ . Can  $W_1 \oplus W_2 = V$  and  $W_1 \cup W_2 = V$  happen?

- ✓ 4.40 Consider Corollary 4.13. Does it work both ways—that is, supposing that  $V = W_1 + \dots + W_k$ , is  $V = W_1 \oplus \dots \oplus W_k$  if and only if  $\dim(V) = \dim(W_1) + \dots + \dim(W_k)$ ?

4.41 We know that if  $V = W_1 \oplus W_2$  then there is a basis for  $V$  that splits into a basis for  $W_1$  and a basis for  $W_2$ . Can we make the stronger statement that every basis for  $V$  splits into a basis for  $W_1$  and a basis for  $W_2$ ?

4.42 We can ask about the algebra of the '+' operation.

- Is it commutative; is  $W_1 + W_2 = W_2 + W_1$ ?
- Is it associative; is  $(W_1 + W_2) + W_3 = W_1 + (W_2 + W_3)$ ?
- Let  $W$  be a subspace of some vector space. Show that  $W + W = W$ .

- (d) Must there be an identity element, a subspace  $I$  such that  $I + W = W + I = W$  for all subspaces  $W$ ?
- (e) Does left-cancellation hold: if  $W_1 + W_2 = W_1 + W_3$  then  $W_2 = W_3$ ? Right cancellation?

4.43 Consider the algebraic properties of the direct sum operation.

- (a) Does direct sum commute: does  $V = W_1 \oplus W_2$  imply that  $V = W_2 \oplus W_1$ ?
- (b) Prove that direct sum is associative:  $(W_1 \oplus W_2) \oplus W_3 = W_1 \oplus (W_2 \oplus W_3)$ .
- (c) Show that  $\mathbb{R}^3$  is the direct sum of the three axes (the relevance here is that by the previous item, we needn't specify which two of the three axes are combined first).
- (d) Does the direct sum operation left-cancel: does  $W_1 \oplus W_2 = W_1 \oplus W_3$  imply  $W_2 = W_3$ ? Does it right-cancel?
- (e) There is an identity element with respect to this operation. Find it.
- (f) Do some, or all, subspaces have inverses with respect to this operation: is there a subspace  $W$  of some vector space such that there is a subspace  $U$  with the property that  $U \oplus W$  equals the identity element from the prior item?

## Fields

Computations involving only integers or only rational numbers are much easier than those with real numbers. Could other algebraic structures, such as the integers or the rationals, work in the place of  $\mathbb{R}$  in the definition of a vector space?

Yes and no. If we take “work” to mean that the results of this chapter remain true then an analysis of the properties of the reals that we have used in this chapter gives a list of conditions that a structure needs in order to “work” in the place of  $\mathbb{R}$ .

**4.1 Definition** A *field* is a set  $\mathcal{F}$  with two operations ‘+’ and ‘·’ such that

(1) for any  $a, b \in \mathcal{F}$  the result of  $a + b$  is in  $\mathcal{F}$  and

- $a + b = b + a$
- if  $c \in \mathcal{F}$  then  $a + (b + c) = (a + b) + c$

(2) for any  $a, b \in \mathcal{F}$  the result of  $a \cdot b$  is in  $\mathcal{F}$  and

- $a \cdot b = b \cdot a$
- if  $c \in \mathcal{F}$  then  $a \cdot (b \cdot c) = (a \cdot b) \cdot c$

(3) if  $a, b, c \in \mathcal{F}$  then  $a \cdot (b + c) = a \cdot b + a \cdot c$

(4) there is an element  $0 \in \mathcal{F}$  such that

- if  $a \in \mathcal{F}$  then  $a + 0 = a$
- for each  $a \in \mathcal{F}$  there is an element  $-a \in \mathcal{F}$  such that  $(-a) + a = 0$

(5) there is an element  $1 \in \mathcal{F}$  such that

- if  $a \in \mathcal{F}$  then  $a \cdot 1 = a$
- for each element  $a \neq 0$  of  $\mathcal{F}$  there is an element  $a^{-1} \in \mathcal{F}$  such that  $a^{-1} \cdot a = 1$ .

The algebraic structure consisting of the set of real numbers along with its



usual addition and multiplication operation is a field, naturally. Another field is the set of rational numbers with its usual addition and multiplication operations. An example of an algebraic structure that is not a field is the integers, because it fails the final condition.

Some examples are surprising. The set  $\{0, 1\}$  under these operations:

$$\begin{array}{c|cc} + & 0 & 1 \\ \hline 0 & 0 & 1 \\ 1 & 1 & 0 \end{array} \quad \begin{array}{c|cc} \cdot & 0 & 1 \\ \hline 0 & 0 & 0 \\ 1 & 0 & 1 \end{array}$$

is a field (see Exercise 5).

We could in this book develop Linear Algebra as the theory of vector spaces with scalars from an arbitrary field. In that case, almost all of the statements here would carry over by replacing ' $\mathbb{R}$ ' with ' $\mathcal{F}$ ', that is, by taking coefficients, vector entries, and matrix entries to be elements of  $\mathcal{F}$  (the exceptions are statements involving distances or angles). Here are some examples; each applies to a vector space  $V$  over a field  $\mathcal{F}$ .

- \* For any  $\vec{v} \in V$  and  $a \in \mathcal{F}$ , (i)  $0 \cdot \vec{v} = \vec{0}$ , (ii)  $-1 \cdot \vec{v} + \vec{v} = \vec{0}$ , and (iii)  $a \cdot \vec{0} = \vec{0}$ .
- \* The span, the set of linear combinations, of a subset of  $V$  is a subspace of  $V$ .
- \* Any subset of a linearly independent set is also linearly independent.
- \* In a finite-dimensional vector space, any two bases have the same number of elements.

(Even statements that don't explicitly mention  $\mathcal{F}$  use field properties in their proof.)

We will not develop vector spaces in this more general setting because the additional abstraction can be a distraction. The ideas we want to bring out already appear when we stick to the reals.

The only exception is Chapter Five. There we must factor polynomials, so we will switch to considering vector spaces over the field of complex numbers.

### Exercises

- 2 Show that the real numbers form a field.
- 3 Prove that these are fields.
  - (a) The rational numbers  $\mathbb{Q}$
  - (b) The complex numbers  $\mathbb{C}$
- 4 Give an example that shows that the integer number system is not a field.
- 5 Consider the set  $\mathcal{B} = \{0, 1\}$  subject to the operations given above. Show that it is a field.
- 6 Give suitable operations to make the set  $\{0, 1, 2\}$  a field.

## Topic

---

# Crystals

Everyone has noticed that table salt comes in little cubes.

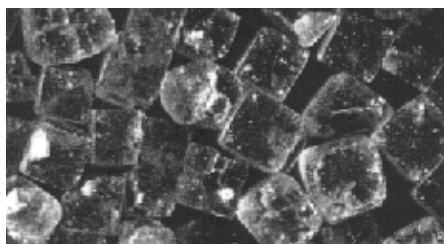

The explanation for the cubical external shape is the simplest one that we could imagine: the internal shape, the way the atoms lie, is also cubical. The internal structure is pictured below. Salt is sodium chloride, and the small spheres shown are sodium while the big ones are chloride. To simplify the view, it only shows the sodiums and chlorides on the front, top, and right.

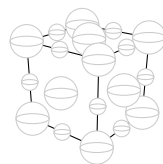

The specks of salt that we see have many repetitions of this fundamental unit. A solid, such as table salt, with a regular internal structure is a *crystal*.

We can restrict our attention to the front face. There we have a square repeated many times.

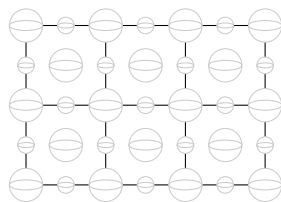

The distance between the corners of the square cell is about 3.34 Ångstroms (an Ångstrom is  $10^{-10}$  meters). Obviously that unit is unwieldy. Instead we can

take as a unit the length of each square's side. That is, we naturally adopt this basis.

$$\left\langle \begin{pmatrix} 3.34 \\ 0 \end{pmatrix}, \begin{pmatrix} 0 \\ 3.34 \end{pmatrix} \right\rangle$$

Then we can describe, say, the corner in the upper right of the picture above as  $3\vec{\beta}_1 + 2\vec{\beta}_2$ .

Another crystal from everyday experience is pencil lead. It is *graphite*, formed from carbon atoms arranged in this shape.

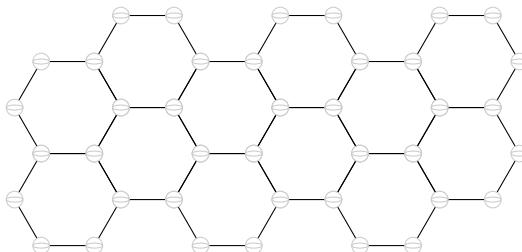

This is a single plane of graphite, called *graphene*. A piece of graphite consists of millions of these planes layered in a stack. The chemical bonds between the planes are much weaker than the bonds inside the planes, which explains why pencils write—the graphite can be sheared so that the planes slide off and are left on the paper.

We can get a convenient unit of length by decomposing the hexagonal ring into three regions that are rotations of this *unit cell*.



The vectors that form the sides of that unit cell make a convenient basis. The distance along the bottom and slant is 1.42 Ångstroms, so this

$$\left\langle \begin{pmatrix} 1.42 \\ 0 \end{pmatrix}, \begin{pmatrix} 1.23 \\ .71 \end{pmatrix} \right\rangle$$

is a good basis.

Another familiar crystal formed from carbon is diamond. Like table salt it is built from cubes but the structure inside each cube is more complicated. In addition to carbons at each corner,

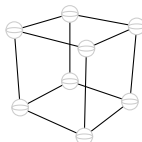

there are carbons in the middle of each face.

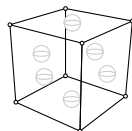

(To show the new face carbons clearly, the corner carbons are reduced to dots.) There are also four more carbons inside the cube, two that are a quarter of the way up from the bottom and two that are a quarter of the way down from the top.

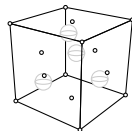

(As before, carbons shown earlier have are reduced here to dots.) The distance along any edge of the cube is 2.18 Ångstroms. Thus, a natural basis for describing the locations of the carbons and the bonds between them, is this.

$$\left\langle \begin{pmatrix} 2.18 \\ 0 \\ 0 \end{pmatrix}, \begin{pmatrix} 0 \\ 2.18 \\ 0 \end{pmatrix}, \begin{pmatrix} 0 \\ 0 \\ 2.18 \end{pmatrix} \right\rangle$$

The examples here show that the structures of crystals is complicated enough to need some organized system to give the locations of the atoms and how they are chemically bound. One tool for that organization is a convenient basis. This application of bases is simple but it shows a natural science context where the idea arises naturally.

### Exercises

- How many fundamental regions are there in one face of a speck of salt? (With a ruler, we can estimate that face is a square that is 0.1 cm on a side.)
- In the graphite picture, imagine that we are interested in a point 5.67 Ångstroms over and 3.14 Ångstroms up from the origin.
  - Express that point in terms of the basis given for graphite.
  - How many hexagonal shapes away is this point from the origin?
  - Express that point in terms of a second basis, where the first basis vector is the same, but the second is perpendicular to the first (going up the plane) and of the same length.
- Give the locations of the atoms in the diamond cube both in terms of the basis, and in Ångstroms.
- This illustrates how we could compute the dimensions of a unit cell from the shape in which a substance crystallizes ([Ebbing], p. 462).
  - Recall that there are  $6.022 \times 10^{23}$  atoms in a mole (this is Avogadro's number). From that, and the fact that platinum has a mass of 195.08 grams per mole, calculate the mass of each atom.
  - Platinum crystallizes in a face-centered cubic lattice with atoms at each lattice point, that is, it looks like the middle picture given above for the diamond crystal. Find the number of platinum's per unit cell (hint: sum the fractions of platinum's that are inside of a single cell).

- (c) From that, find the mass of a unit cell.
- (d) Platinum crystal has a density of 21.45 grams per cubic centimeter. From this, and the mass of a unit cell, calculate the volume of a unit cell.
- (e) Find the length of each edge.
- (f) Describe a natural three-dimensional basis.

## Topic

---

### Voting Paradoxes

Imagine that a Political Science class studying the American presidential process holds a mock election. The 29 class members rank the Democratic Party, Republican Party, and Third Party nominees, from most preferred to least preferred (> means 'is preferred to').

<i>preference order</i>	<i>number with that preference</i>
Democrat > Republican > Third	5
Democrat > Third > Republican	4
Republican > Democrat > Third	2
Republican > Third > Democrat	8
Third > Democrat > Republican	8
Third > Republican > Democrat	2

What is the preference of the group as a whole?

Overall, the group prefers the Democrat to the Republican by five votes; seventeen voters ranked the Democrat above the Republican versus twelve the other way. And the group prefers the Republican to the Third's nominee, fifteen to fourteen. But, strangely enough, the group also prefers the Third to the Democrat, eighteen to eleven.

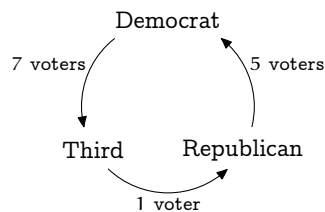

This is a *voting paradox*, specifically, a *majority cycle*.

Mathematicians study voting paradoxes in part because of their implications for practical politics. For instance, the instructor of this class can manipulate them into choosing the Democrat as the overall winner by first asking for a vote to choose between the Republican and the Third, and then asking for a vote to choose between the winner of that contest, the Republican, and the Democrat.

The instructor can make any of the other two candidates come out as the winner by similar manipulations. (Here we will stick to three-candidate elections but the same thing happens in larger elections.)

Mathematicians also study voting paradoxes simply because they are interesting. One interesting aspect is that the group's overall majority cycle occurs despite that each single voter's preference list is *rational*, in a straight-line order. That is, the majority cycle seems to arise in the aggregate without being present in the components of that aggregate, the preference lists. However we can use linear algebra to argue that a tendency toward cyclic preference is actually present in each voter's list and that it surfaces when there is more adding of the tendency than canceling.

For this, abbreviating the choices as D, R, and T, we can describe how a voter with preference order  $D > R > T$  contributes to the above cycle.

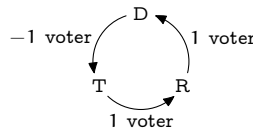

(The negative sign is here because the arrow describes T as preferred to D, but this voter likes them the other way.) The descriptions for the other preference lists are in the table on page 143.

Now, to conduct the election we linearly combine these descriptions; for instance, the Political Science mock election

$$5 \cdot \begin{array}{c} \text{D} \\ \curvearrowright \\ \text{T} \quad \text{R} \\ \curvearrowleft \\ \text{D} \end{array} + 4 \cdot \begin{array}{c} \text{D} \\ \curvearrowright \\ \text{T} \quad \text{R} \\ \curvearrowleft \\ \text{D} \end{array} + \dots + 2 \cdot \begin{array}{c} \text{D} \\ \curvearrowright \\ \text{T} \quad \text{R} \\ \curvearrowleft \\ \text{D} \end{array}$$

yields the circular group preference shown earlier.

Of course, taking linear combinations is linear algebra. The graphical cycle notation is suggestive but inconvenient so we use column vectors by starting at the D and taking the numbers from the cycle in counterclockwise order. Thus, we represent the mock election and a single  $D > R > T$  vote in this way.

$$\begin{pmatrix} 7 \\ 1 \\ 5 \end{pmatrix} \quad \text{and} \quad \begin{pmatrix} -1 \\ 1 \\ 1 \end{pmatrix}$$

We will decompose vote vectors into two parts, one cyclic and the other acyclic. For the first part, we say that a vector is *purely cyclic* if it is in this subspace of  $\mathbb{R}^3$ .

$$C = \left\{ \begin{pmatrix} k \\ k \\ k \end{pmatrix} \mid k \in \mathbb{R} \right\} = \left\{ k \cdot \begin{pmatrix} 1 \\ 1 \\ 1 \end{pmatrix} \mid k \in \mathbb{R} \right\}$$

For the second part, consider the set of vectors that are perpendicular to all of the vectors in  $C$ . Exercise 6 shows that this is a subspace.

$$\begin{aligned}
 C^\perp &= \left\{ \begin{pmatrix} c_1 \\ c_2 \\ c_3 \end{pmatrix} \mid \begin{pmatrix} c_1 \\ c_2 \\ c_3 \end{pmatrix} \cdot \begin{pmatrix} k \\ k \\ k \end{pmatrix} = 0 \text{ for all } k \in \mathbb{R} \right\} \\
 &= \left\{ \begin{pmatrix} c_1 \\ c_2 \\ c_3 \end{pmatrix} \mid c_1 + c_2 + c_3 = 0 \right\} = \left\{ c_2 \begin{pmatrix} -1 \\ 1 \\ 0 \end{pmatrix} + c_3 \begin{pmatrix} -1 \\ 0 \\ 1 \end{pmatrix} \mid c_2, c_3 \in \mathbb{R} \right\}
 \end{aligned}$$

(Read the name as “ $C$  perp.”) So we are led to this basis for  $\mathbb{R}^3$ .

$$\left\langle \begin{pmatrix} 1 \\ 1 \\ 1 \end{pmatrix}, \begin{pmatrix} -1 \\ 1 \\ 0 \end{pmatrix}, \begin{pmatrix} -1 \\ 0 \\ 1 \end{pmatrix} \right\rangle$$

We can represent votes with respect to this basis, and thereby decompose them into a cyclic part and an acyclic part. (Note for readers who have covered the optional section in this chapter: that is, the space is the direct sum of  $C$  and  $C^\perp$ .)

For example, consider the  $D > R > T$  voter discussed above. We represent it with respect to the basis

$$\begin{array}{rcl}
 c_1 - c_2 - c_3 = -1 & & c_1 - c_2 - c_3 = -1 \\
 c_1 + c_2 = 1 & \xrightarrow{-\rho_1 + \rho_2} \quad \xrightarrow{(-1/2)\rho_2 + \rho_3} & 2c_2 + c_3 = 2 \\
 c_1 + c_3 = 1 & \xrightarrow{-\rho_1 + \rho_3} & (3/2)c_3 = 1
 \end{array}$$

using the coordinates  $c_1 = 1/3$ ,  $c_2 = 2/3$ , and  $c_3 = 2/3$ . Then

$$\begin{pmatrix} -1 \\ 1 \\ 1 \end{pmatrix} = \frac{1}{3} \cdot \begin{pmatrix} 1 \\ 1 \\ 1 \end{pmatrix} + \frac{2}{3} \cdot \begin{pmatrix} -1 \\ 1 \\ 0 \end{pmatrix} + \frac{2}{3} \cdot \begin{pmatrix} -1 \\ 0 \\ 1 \end{pmatrix} = \begin{pmatrix} 1/3 \\ 1/3 \\ 1/3 \end{pmatrix} + \begin{pmatrix} -4/3 \\ 2/3 \\ 2/3 \end{pmatrix}$$

gives the desired decomposition into a cyclic part and an acyclic part.

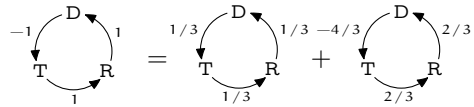

Thus we can see that this  $D > R > T$  voter’s rational preference list does have a cyclic part.

The  $T > R > D$  voter is opposite to the one just considered in that the ‘ $>$ ’ symbols are reversed. This voter’s decomposition

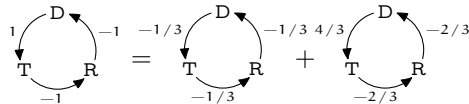

shows that these opposite preferences have decompositions that are opposite. We say that the first voter has positive *spin* since the cycle part is with the



direction that we have chosen for the arrows, while the second voter's spin is negative.

The fact that these opposite voters cancel each other is reflected in the fact that their vote vectors add to zero. This suggests an alternate way to tally an election. We could first cancel as many opposite preference lists as possible, and then determine the outcome by adding the remaining lists.

The rows of the table below contain the three pairs of opposite preference lists. The columns group those pairs by spin. For instance, the first row contains the two voters just considered.

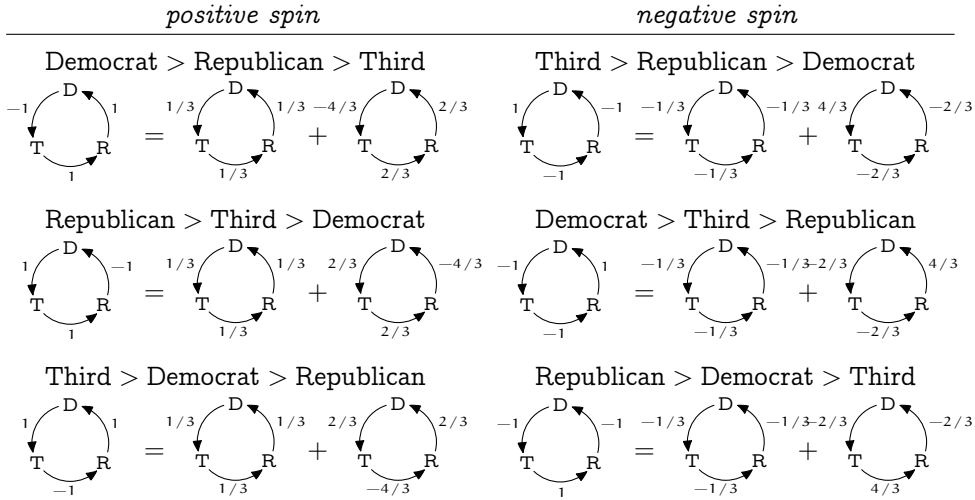

If we conduct the election as just described then after the cancellation of as many opposite pairs of voters as possible then there will be left three sets of preference lists: one set from the first row, one from the second row, and one from the third row. We will finish by proving that a voting paradox can happen only if the spins of these three sets are in the same direction. That is, for a voting paradox to occur, the three remaining sets must all come from the left of the table or all come from the right (see Exercise 3). This shows that there is some connection between the majority cycle and the decomposition that we are using — a voting paradox can happen only when the tendencies toward cyclic preference reinforce each other.

For the proof, assume that we have cancelled opposite preference orders and we are left with one set of preference lists from each of the three rows. Consider the sum of these three (here, the numbers  $a$ ,  $b$ , and  $c$  could be positive, negative, or zero).

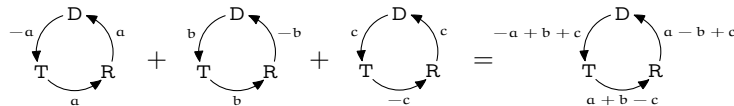

A voting paradox occurs when the three numbers on the right,  $a - b + c$  and  $a + b - c$  and  $-a + b + c$ , are all nonnegative or all nonpositive. On the left,

at least two of the three numbers  $a$  and  $b$  and  $c$  are both nonnegative or both nonpositive. We can assume that they are  $a$  and  $b$ . That makes four cases: the cycle is nonnegative and  $a$  and  $b$  are nonnegative, the cycle is nonpositive and  $a$  and  $b$  are nonpositive, etc. We will do only the first case, since the second is similar and the other two are also easy.

So assume that the cycle is nonnegative and that  $a$  and  $b$  are nonnegative. The conditions  $0 \leq a - b + c$  and  $0 \leq -a + b + c$  add to give that  $0 \leq 2c$ , which implies that  $c$  is also nonnegative, as desired. That ends the proof.

This result says only that having all three spin in the same direction is a necessary condition for a majority cycle. It is not sufficient; see Exercise 4.

Voting theory and associated topics are the subject of current research. There are many intriguing results, most notably the one produced by K Arrow [Arrow], who won the Nobel Prize in part for this work, showing that no voting system is entirely fair (for a reasonable definition of “fair”). For more information, some good introductory articles are [Gardner, 1970], [Gardner, 1974], [Gardner, 1980], and [Neimi & Riker]. [Taylor] is a readable recent book. The long list of cases from recent American political history in [Poundstone] shows these paradoxes are routinely manipulated in practice.

This Topic is largely drawn from [Zwicker]. (*Author’s Note: I would like to thank Professor Zwicker for his kind and illuminating discussions.*)

### Exercises

1 Here is a reasonable way in which a voter could have a cyclic preference. Suppose that this voter ranks each candidate on each of three criteria.

- (a) Draw up a table with the rows labeled ‘Democrat’, ‘Republican’, and ‘Third’, and the columns labeled ‘character’, ‘experience’, and ‘policies’. Inside each column, rank some candidate as most preferred, rank another as in the middle, and rank the remaining one as least preferred.
- (b) In this ranking, is the Democrat preferred to the Republican in (at least) two out of three criteria, or vice versa? Is the Republican preferred to the Third?
- (c) Does the table that was just constructed have a cyclic preference order? If not, make one that does.

So it is possible for a voter to have a cyclic preference among candidates. The paradox described above, however, is that even if each voter has a straight-line preference list, a cyclic preference can still arise for the entire group.

2 Compute the values in the table of decompositions.

3 Do the cancellations of opposite preference orders for the Political Science class’s mock election. Are all the remaining preferences from the left three rows of the table or from the right?

4 The necessary condition that is proved above — a voting paradox can happen only if all three preference lists remaining after cancellation have the same spin — is not also sufficient.

- (a) Continuing the positive cycle case considered in the proof, use the two inequalities  $0 \leq a - b + c$  and  $0 \leq -a + b + c$  to show that  $|a - b| \leq c$ .
- (b) Also show that  $c \leq a + b$ , and hence that  $|a - b| \leq c \leq a + b$ .
- (c) Give an example of a vote where there is a majority cycle, and addition of one more voter with the same spin causes the cycle to go away.

- (d) Can the opposite happen; can addition of one voter with a “wrong” spin cause a cycle to appear?
- (e) Give a condition that is both necessary and sufficient to get a majority cycle.
- 5 A one-voter election cannot have a majority cycle because of the requirement that we’ve imposed that the voter’s list must be rational.
- (a) Show that a two-voter election may have a majority cycle. (We consider the group preference a majority cycle if all three group totals are nonnegative or if all three are nonpositive—that is, we allow some zero’s in the group preference.)
- (b) Show that for any number of voters greater than one, there is an election involving that many voters that results in a majority cycle.
- 6 Let  $U$  be a subspace of  $\mathbb{R}^3$ . Prove that the set  $U^\perp = \{\vec{v} \mid \vec{v} \cdot \vec{u} = 0 \text{ for all } \vec{u} \in U\}$  of vectors that are perpendicular to each vector in  $U$  is also subspace of  $\mathbb{R}^3$ . Does this hold if  $U$  is not a subspace?

## Dimensional Analysis

“You can’t add apples and oranges,” the old saying goes. It reflects our experience that in applications the quantities have units and keeping track of those units can help with problems. Everyone has done calculations such as this one that use the units as a check.

$$60 \frac{\text{sec}}{\text{min}} \cdot 60 \frac{\text{min}}{\text{hr}} \cdot 24 \frac{\text{hr}}{\text{day}} \cdot 365 \frac{\text{day}}{\text{year}} = 31\,536\,000 \frac{\text{sec}}{\text{year}}$$

However, we can take the idea of including the units beyond bookkeeping. We can use units to draw conclusions about what relationships are possible among the physical quantities.

To start, consider the falling body equation  $\text{distance} = 16 \cdot (\text{time})^2$ . If the distance is in feet and the time is in seconds then this is a true statement. However it is not correct in other unit systems, because 16 isn’t the right constant in those systems. We can fix that by attaching units to the 16, making it a *dimensional constant*.

$$\text{dist} = 16 \frac{\text{ft}}{\text{sec}^2} \cdot (\text{time})^2$$

Now the equation holds also in the meter-second system because when we align the units (a foot is approximately 0.30 meters),

$$\text{distance in meters} = 16 \frac{0.30 \text{ m}}{\text{sec}^2} \cdot (\text{time in sec})^2 = 4.8 \frac{\text{m}}{\text{sec}^2} \cdot (\text{time in sec})^2$$

the constant gets adjusted. So, in order to look at equations that are correct across unit systems, we restrict our attention to those that use dimensional constants; such an equation is said to be *complete*.

Moving away from a specific unit system allows us to just say that we measure all quantities here in combinations of some units of length L, mass M, and time T. These three are our *dimensions*. For instance, we could measure velocity could in feet/second or fathoms/hour but at all events it involves a unit of length divided by a unit of time so the *dimensional formula* of velocity is L/T. Similarly, we could state density’s dimensional formula as M/L<sup>3</sup>.

To write the dimensional formula we shall use negative exponents instead of fractions and we shall include the dimensions with a zero exponent. Thus we

will write the dimensional formula of velocity as  $L^1M^0T^{-1}$  and that of density as  $L^{-3}M^1T^0$ .

Thus, “you can’t add apples to oranges” becomes the advice to check that all of an equation’s terms have the same dimensional formula. An example is this version of the falling body equation  $d - gt^2 = 0$ . The dimensional formula of the  $d$  term is  $L^1M^0T^0$ . For the other term, the dimensional formula of  $g$  is  $L^1M^0T^{-2}$  ( $g$  is given above as  $16\text{ ft/sec}^2$ ) and the dimensional formula of  $t$  is  $L^0M^0T^1$  so that of the entire  $gt^2$  term is  $L^1M^0T^{-2}(L^0M^0T^1)^2 = L^1M^0T^0$ . Thus the two terms have the same dimensional formula. An equation with this property is *dimensionally homogeneous*.

Quantities with dimensional formula  $L^0M^0T^0$  are *dimensionless*. For example, we measure an angle by taking the ratio of the subtended arc to the radius

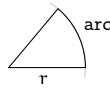

which is the ratio of a length to a length  $(L^1M^0T^0)(L^1M^0T^0)^{-1}$  and thus angles have the dimensional formula  $L^0M^0T^0$ .

The classic example of using the units for more than bookkeeping, using them to draw conclusions, considers the formula for the period of a pendulum.

$$p = \text{--some expression involving the length of the string, etc.--}$$

The period is in units of time  $L^0M^0T^1$ . So the quantities on the other side of the equation must have dimensional formulas that combine in such a way that their  $L$ 's and  $M$ 's cancel and only a single  $T$  remains. The table on page 148 has the quantities that an experienced investigator would consider possibly relevant to the period of a pendulum. The only dimensional formulas involving  $L$  are for the length of the string and the acceleration due to gravity. For the  $L$ 's of these two to cancel, when they appear in the equation they must be in ratio, e.g., as  $(\ell/g)^2$ , or as  $\cos(\ell/g)$ , or as  $(\ell/g)^{-1}$ . Therefore the period is a function of  $\ell/g$ .

This is a remarkable result: with a pencil and paper analysis, before we ever took out the pendulum and made measurements, we have determined something about what makes up its period.

To do dimensional analysis systematically, we need to know two things (arguments for these are in [Bridgman], Chapter II and IV). The first is that each equation relating physical quantities that we shall see involves a sum of terms, where each term has the form

$$m_1^{p_1} m_2^{p_2} \dots m_k^{p_k}$$

for numbers  $m_1, \dots, m_k$  that measure the quantities.

For the second, observe that an easy way to construct a dimensionally homogeneous expression is by taking a product of dimensionless quantities or by adding such dimensionless terms. Buckingham’s Theorem states that

any complete relationship among quantities with dimensional formulas can be algebraically manipulated into a form where there is some function  $f$  such that

$$f(\Pi_1, \dots, \Pi_n) = 0$$

for a complete set  $\{\Pi_1, \dots, \Pi_n\}$  of dimensionless products. (The first example below describes what makes a set of dimensionless products ‘complete’.) We usually want to express one of the quantities  $m_1$  for instance, in terms of the others, and for that we will assume that the above equality can be rewritten

$$m_1 = m_2^{-p_2} \dots m_k^{-p_k} \cdot \hat{f}(\Pi_2, \dots, \Pi_n)$$

where  $\Pi_1 = m_1 m_2^{p_2} \dots m_k^{p_k}$  is dimensionless and the products  $\Pi_2, \dots, \Pi_n$  don’t involve  $m_1$  (as with  $f$ , here  $\hat{f}$  is just some function, this time of  $n - 1$  arguments). Thus, to do dimensional analysis we should find which dimensionless products are possible.

For example, consider again the formula for a pendulum’s period.

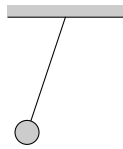

	<i>quantity</i>	<i>dimensional formula</i>
	period $p$	$L^0 M^0 T^1$
	length of string $\ell$	$L^1 M^0 T^0$
	mass of bob $m$	$L^0 M^1 T^0$
	acceleration due to gravity $g$	$L^1 M^0 T^{-2}$
	arc of swing $\theta$	$L^0 M^0 T^0$

By the first fact cited above, we expect the formula to have (possibly sums of terms of) the form  $p^{p_1} \ell^{p_2} m^{p_3} g^{p_4} \theta^{p_5}$ . To use the second fact, to find which combinations of the powers  $p_1, \dots, p_5$  yield dimensionless products, consider this equation.

$$(L^0 M^0 T^1)^{p_1} (L^1 M^0 T^0)^{p_2} (L^0 M^1 T^0)^{p_3} (L^1 M^0 T^{-2})^{p_4} (L^0 M^0 T^0)^{p_5} = L^0 M^0 T^0$$

It gives three conditions on the powers.

$$\begin{aligned} p_2 + p_4 &= 0 \\ p_3 &= 0 \\ p_1 - 2p_4 &= 0 \end{aligned}$$

Note that  $p_3 = 0$  so the mass of the bob does not affect the period. Gaussian reduction and parametrization of that system gives this

$$\left\{ \begin{pmatrix} p_1 \\ p_2 \\ p_3 \\ p_4 \\ p_5 \end{pmatrix} = \begin{pmatrix} 1 \\ -1/2 \\ 0 \\ 1/2 \\ 0 \end{pmatrix} p_1 + \begin{pmatrix} 0 \\ 0 \\ 0 \\ 0 \\ 1 \end{pmatrix} p_5 \mid p_1, p_5 \in \mathbb{R} \right\}$$

(we’ve taken  $p_1$  as one of the parameters in order to express the period in terms of the other quantities).

The set of dimensionless products contains all terms  $p^{p_1} \ell^{p_2} m^{p_3} a^{p_4} \theta^{p_5}$  subject to the conditions above. This set forms a vector space under the ‘+’ operation of multiplying two such products and the ‘.’ operation of raising such a product to the power of the scalar (see Exercise 5). The term ‘complete set of dimensionless products’ in Buckingham’s Theorem means a basis for this vector space.

We can get a basis by first taking  $p_1 = 1, p_5 = 0$ , and then taking  $p_1 = 0, p_5 = 1$ . The associated dimensionless products are  $\Pi_1 = p\ell^{-1/2}g^{1/2}$  and  $\Pi_2 = \theta$ . Because the set  $\{\Pi_1, \Pi_2\}$  is complete, Buckingham’s Theorem says that

$$p = \ell^{1/2}g^{-1/2} \cdot \hat{f}(\theta) = \sqrt{\ell/g} \cdot \hat{f}(\theta)$$

where  $\hat{f}$  is a function that we cannot determine from this analysis (a first year physics text will show by other means that for small angles it is approximately the constant function  $\hat{f}(\theta) = 2\pi$ ).

Thus, analysis of the relationships that are possible between the quantities with the given dimensional formulas has given us a fair amount of information: a pendulum’s period does not depend on the mass of the bob, and it rises with the square root of the length of the string.

For the next example we try to determine the period of revolution of two bodies in space orbiting each other under mutual gravitational attraction. An experienced investigator could expect that these are the relevant quantities.



<i>quantity</i>	<i>dimensional formula</i>
period $p$	$L^0 M^0 T^1$
mean separation $r$	$L^1 M^0 T^0$
first mass $m_1$	$L^0 M^1 T^0$
second mass $m_2$	$L^0 M^1 T^0$
gravitational constant $G$	$L^3 M^{-1} T^{-2}$

To get the complete set of dimensionless products we consider the equation

$$(L^0 M^0 T^1)^{p_1} (L^1 M^0 T^0)^{p_2} (L^0 M^1 T^0)^{p_3} (L^0 M^1 T^0)^{p_4} (L^3 M^{-1} T^{-2})^{p_5} = L^0 M^0 T^0$$

which results in a system

$$\begin{array}{rcl} p_2 & + & 3p_5 = 0 \\ p_3 + p_4 - p_5 & = & 0 \\ p_1 & - & 2p_5 = 0 \end{array}$$

with this solution.

$$\left\{ \begin{pmatrix} 1 \\ -3/2 \\ 1/2 \\ 0 \\ 1/2 \end{pmatrix} p_1 + \begin{pmatrix} 0 \\ 0 \\ -1 \\ 1 \\ 0 \end{pmatrix} p_4 \mid p_1, p_4 \in \mathbb{R} \right\}$$

As earlier, the set of dimensionless products of these quantities forms a vector space and we want to produce a basis for that space, a ‘complete’ set of dimensionless products. One such set, gotten from setting  $p_1 = 1$  and  $p_4 = 0$  and also setting  $p_1 = 0$  and  $p_4 = 1$  is  $\{\Pi_1 = pr^{-3/2}m_1^{1/2}G^{1/2}, \Pi_2 = m_1^{-1}m_2\}$ . With that, Buckingham’s Theorem says that any complete relationship among these quantities is stateable this form.

$$p = r^{3/2}m_1^{-1/2}G^{-1/2} \cdot \hat{f}(m_1^{-1}m_2) = \frac{r^{3/2}}{\sqrt{Gm_1}} \cdot \hat{f}(m_2/m_1)$$

*Remark.* An important application of the prior formula is when  $m_1$  is the mass of the sun and  $m_2$  is the mass of a planet. Because  $m_1$  is very much greater than  $m_2$ , the argument to  $\hat{f}$  is approximately 0, and we can wonder whether this part of the formula remains approximately constant as  $m_2$  varies. One way to see that it does is this. The sun is so much larger than the planet that the mutual rotation is approximately about the sun’s center. If we vary the planet’s mass  $m_2$  by a factor of  $\chi$  (e.g., Venus’s mass is  $\chi = 0.815$  times Earth’s mass), then the force of attraction is multiplied by  $\chi$ , and  $\chi$  times the force acting on  $\chi$  times the mass gives, since  $F = ma$ , the same acceleration, about the same center (approximately). Hence, the orbit will be the same and so its period will be the same, and thus the right side of the above equation also remains unchanged (approximately). Therefore,  $\hat{f}(m_2/m_1)$  is approximately constant as  $m_2$  varies. This is Kepler’s Third Law: the square of the period of a planet is proportional to the cube of the mean radius of its orbit about the sun.

The final example was one of the first explicit applications of dimensional analysis. Lord Raleigh considered the speed of a wave in deep water and suggested these as the relevant quantities.

<i>quantity</i>	<i>dimensional formula</i>
velocity of the wave $v$	$L^1M^0T^{-1}$
density of the water $d$	$L^{-3}M^1T^0$
acceleration due to gravity $g$	$L^1M^0T^{-2}$
wavelength $\lambda$	$L^1M^0T^0$

The equation

$$(L^1M^0T^{-1})^{p_1}(L^{-3}M^1T^0)^{p_2}(L^1M^0T^{-2})^{p_3}(L^1M^0T^0)^{p_4} = L^0M^0T^0$$

gives this system

$$\begin{array}{rcl} p_1 - 3p_2 + p_3 + p_4 & = & 0 \\ p_2 & = & 0 \\ -p_1 & - 2p_3 & = 0 \end{array}$$

with this solution space.

$$\left\{ \begin{pmatrix} 1 \\ 0 \\ -1/2 \\ -1/2 \end{pmatrix} p_1 \mid p_1 \in \mathbb{R} \right\}$$



There is one dimensionless product,  $\Pi_1 = v_0 g^{-1/2} \lambda^{-1/2}$ , and so  $v$  is  $\sqrt{\lambda g}$  times a constant;  $\hat{f}$  is constant since it is a function of no arguments. The quantity  $d$  is not involved in the relationship.

The three examples above show that dimensional analysis can bring us far toward expressing the relationship among the quantities. For further reading, the classic reference is [Bridgman]—this brief book is delightful. Another source is [Giordano, Wells, Wilde]. A description of dimensional analysis’s place in modeling is in [Giordano, Jaye, Weir].

**Exercises**

- 1 [de Mestre] Consider a projectile, launched with initial velocity  $v_0$ , at an angle  $\theta$ . To study its motion we may guess that these are the relevant quantities.

<i>quantity</i>	<i>dimensional formula</i>
horizontal position $x$	$L^1 M^0 T^0$
vertical position $y$	$L^1 M^0 T^0$
initial speed $v_0$	$L^1 M^0 T^{-1}$
angle of launch $\theta$	$L^0 M^0 T^0$
acceleration due to gravity $g$	$L^1 M^0 T^{-2}$
time $t$	$L^0 M^0 T^1$

- (a) Show that  $\{gt/v_0, gx/v_0^2, gy/v_0^2, \theta\}$  is a complete set of dimensionless products. (*Hint.* One way to go is to find the appropriate free variables in the linear system that arises but there is a shortcut that uses the properties of a basis.)
- (b) These two equations of motion for projectiles are familiar:  $x = v_0 \cos(\theta)t$  and  $y = v_0 \sin(\theta)t - (g/2)t^2$ . Manipulate each to rewrite it as a relationship among the dimensionless products of the prior item.
- 2 [Einstein] conjectured that the infrared characteristic frequencies of a solid might be determined by the same forces between atoms as determine the solid’s ordinary elastic behavior. The relevant quantities are these.

<i>quantity</i>	<i>dimensional formula</i>
characteristic frequency $\nu$	$L^0 M^0 T^{-1}$
compressibility $k$	$L^1 M^{-1} T^2$
number of atoms per cubic cm $N$	$L^{-3} M^0 T^0$
mass of an atom $m$	$L^0 M^1 T^0$

Show that there is one dimensionless product. Conclude that, in any complete relationship among quantities with these dimensional formulas,  $k$  is a constant times  $\nu^{-2} N^{-1/3} m^{-1}$ . This conclusion played an important role in the early study of quantum phenomena.

- 3 [Giordano, Wells, Wilde] The torque produced by an engine has dimensional formula  $L^2 M^1 T^{-2}$ . We may first guess that it depends on the engine’s rotation rate (with dimensional formula  $L^0 M^0 T^{-1}$ ), and the volume of air displaced (with dimensional formula  $L^3 M^0 T^0$ ).
- (a) Try to find a complete set of dimensionless products. What goes wrong?
- (b) Adjust the guess by adding the density of the air (with dimensional formula  $L^{-3} M^1 T^0$ ). Now find a complete set of dimensionless products.
- 4 [Tilley] Dominoes falling make a wave. We may conjecture that the wave speed  $v$  depends on the spacing  $d$  between the dominoes, the height  $h$  of each domino, and the acceleration due to gravity  $g$ .
- (a) Find the dimensional formula for each of the four quantities.

- (b) Show that  $\{\Pi_1 = h/d, \Pi_2 = dg/v^2\}$  is a complete set of dimensionless products.  
 (c) Show that if  $h/d$  is fixed then the propagation speed is proportional to the square root of  $d$ .

5 Prove that the dimensionless products form a vector space under the  $\vec{+}$  operation of multiplying two such products and the  $\vec{r}$  operation of raising such the product to the power of the scalar. (The vector arrows are a precaution against confusion.) That is, prove that, for any particular homogeneous system, this set of products of powers of  $m_1, \dots, m_k$

$$\{m_1^{p_1} \dots m_k^{p_k} \mid p_1, \dots, p_k \text{ satisfy the system}\}$$

is a vector space under:

$$m_1^{p_1} \dots m_k^{p_k} \vec{+} m_1^{q_1} \dots m_k^{q_k} = m_1^{p_1+q_1} \dots m_k^{p_k+q_k}$$

and

$$r\vec{r}(m_1^{p_1} \dots m_k^{p_k}) = m_1^{rp_1} \dots m_k^{rp_k}$$

(assume that all variables represent real numbers).

- 6 The advice about apples and oranges is not right. Consider the familiar equations for a circle  $C = 2\pi r$  and  $A = \pi r^2$ .
- (a) Check that  $C$  and  $A$  have different dimensional formulas.  
 (b) Produce an equation that is not dimensionally homogeneous (i.e., it adds apples and oranges) but is nonetheless true of any circle.  
 (c) The prior item asks for an equation that is complete but not dimensionally homogeneous. Produce an equation that is dimensionally homogeneous but not complete.

(Just because the old saying isn't strictly right, doesn't keep it from being a useful strategy. Dimensional homogeneity is often used to check the plausibility of equations used in models. For an argument that any complete equation can easily be made dimensionally homogeneous, see [Bridgman], Chapter I, especially page 15.)

# Maps Between Spaces

## I Isomorphisms

In the examples following the definition of a vector space we expressed the idea that some spaces are “the same” as others. For instance, the space of two-tall column vectors and the space of two-wide row vectors are not equal because their elements — column vectors and row vectors — are not equal, but we have the idea that these spaces differ only in how their elements appear. We will now make this intuition precise.

This section illustrates a common aspect of a mathematical investigation. With the help of some examples, we’ve gotten an idea. We will next give a formal definition and then we will produce some results backing our contention that the definition captures the idea. We’ve seen this happen already, for instance in the first section of the Vector Space chapter. There, the study of linear systems led us to consider collections closed under linear combinations. We defined such a collection as a vector space and we followed it with some supporting results.

That definition wasn’t an end point, instead it led to new insights such as the idea of a basis. Here too, after producing a definition and supporting it, we will get two surprises (pleasant ones). First, we will find that the definition applies to some unforeseen, and interesting, cases. Second, the study of the definition will lead to new ideas. In this way, our investigation will build momentum.

### I.1 Definition and Examples

We start with two examples that suggest the right definition.

**1.1 Example** The space of two-wide row vectors and the space of two-tall column vectors are “the same” in that if we associate the vectors that have the same components, e.g.,

$$\begin{pmatrix} 1 & 2 \end{pmatrix} \longleftrightarrow \begin{pmatrix} 1 \\ 2 \end{pmatrix}$$

then this correspondence preserves the operations, for instance this addition

$$\begin{pmatrix} 1 & 2 \end{pmatrix} + \begin{pmatrix} 3 & 4 \end{pmatrix} = \begin{pmatrix} 4 & 6 \end{pmatrix} \longleftrightarrow \begin{pmatrix} 1 \\ 2 \end{pmatrix} + \begin{pmatrix} 3 \\ 4 \end{pmatrix} = \begin{pmatrix} 4 \\ 6 \end{pmatrix}$$

and this scalar multiplication.

$$5 \cdot \begin{pmatrix} 1 & 2 \end{pmatrix} = \begin{pmatrix} 5 & 10 \end{pmatrix} \longleftrightarrow 5 \cdot \begin{pmatrix} 1 \\ 2 \end{pmatrix} = \begin{pmatrix} 5 \\ 10 \end{pmatrix}$$

More generally stated, under the correspondence

$$\begin{pmatrix} a_0 & a_1 \end{pmatrix} \longleftrightarrow \begin{pmatrix} a_0 \\ a_1 \end{pmatrix}$$

both operations are preserved:

$$\begin{pmatrix} a_0 & a_1 \end{pmatrix} + \begin{pmatrix} b_0 & b_1 \end{pmatrix} = \begin{pmatrix} a_0 + b_0 & a_1 + b_1 \end{pmatrix} \longleftrightarrow \begin{pmatrix} a_0 \\ a_1 \end{pmatrix} + \begin{pmatrix} b_0 \\ b_1 \end{pmatrix} = \begin{pmatrix} a_0 + b_0 \\ a_1 + b_1 \end{pmatrix}$$

and

$$r \cdot \begin{pmatrix} a_0 & a_1 \end{pmatrix} = \begin{pmatrix} ra_0 & ra_1 \end{pmatrix} \longleftrightarrow r \cdot \begin{pmatrix} a_0 \\ a_1 \end{pmatrix} = \begin{pmatrix} ra_0 \\ ra_1 \end{pmatrix}$$

(all of the variables are real numbers).

**1.2 Example** Another two spaces we can think of as “the same” are  $\mathcal{P}_2$ , the space of quadratic polynomials, and  $\mathbb{R}^3$ . A natural correspondence is this.

$$a_0 + a_1x + a_2x^2 \longleftrightarrow \begin{pmatrix} a_0 \\ a_1 \\ a_2 \end{pmatrix} \quad (\text{e.g., } 1 + 2x + 3x^2 \longleftrightarrow \begin{pmatrix} 1 \\ 2 \\ 3 \end{pmatrix})$$

This preserves structure: corresponding elements add in a corresponding way

$$\frac{a_0 + a_1x + a_2x^2 + b_0 + b_1x + b_2x^2}{(a_0 + b_0) + (a_1 + b_1)x + (a_2 + b_2)x^2} \longleftrightarrow \begin{pmatrix} a_0 \\ a_1 \\ a_2 \end{pmatrix} + \begin{pmatrix} b_0 \\ b_1 \\ b_2 \end{pmatrix} = \begin{pmatrix} a_0 + b_0 \\ a_1 + b_1 \\ a_2 + b_2 \end{pmatrix}$$

and scalar multiplication also corresponds.

$$r \cdot (a_0 + a_1x + a_2x^2) = (ra_0) + (ra_1)x + (ra_2)x^2 \longleftrightarrow r \cdot \begin{pmatrix} a_0 \\ a_1 \\ a_2 \end{pmatrix} = \begin{pmatrix} ra_0 \\ ra_1 \\ ra_2 \end{pmatrix}$$

**1.3 Definition** An *isomorphism* between two vector spaces  $V$  and  $W$  is a map  $f: V \rightarrow W$  that

(1) is a correspondence:  $f$  is one-to-one and onto;\*

(2) *preserves structure*: if  $\vec{v}_1, \vec{v}_2 \in V$  then

$$f(\vec{v}_1 + \vec{v}_2) = f(\vec{v}_1) + f(\vec{v}_2)$$

and if  $\vec{v} \in V$  and  $r \in \mathbb{R}$  then

$$f(r\vec{v}) = rf(\vec{v})$$

(we write  $V \cong W$ , read “ $V$  is isomorphic to  $W$ ”, when such a map exists).

(“Morphism” means map, so “isomorphism” means a map expressing sameness.)

**1.4 Example** The vector space  $G = \{c_1 \cos \theta + c_2 \sin \theta \mid c_1, c_2 \in \mathbb{R}\}$  of functions of  $\theta$  is isomorphic to the vector space  $\mathbb{R}^2$  under this map.

$$c_1 \cos \theta + c_2 \sin \theta \xrightarrow{f} \begin{pmatrix} c_1 \\ c_2 \end{pmatrix}$$

We will check this by going through the conditions in the definition.

We will first verify condition (1), that the map is a correspondence between the sets underlying the spaces.

To establish that  $f$  is one-to-one, we must prove that  $f(\vec{a}) = f(\vec{b})$  only when  $\vec{a} = \vec{b}$ . If

$$f(a_1 \cos \theta + a_2 \sin \theta) = f(b_1 \cos \theta + b_2 \sin \theta)$$

then, by the definition of  $f$ ,

$$\begin{pmatrix} a_1 \\ a_2 \end{pmatrix} = \begin{pmatrix} b_1 \\ b_2 \end{pmatrix}$$

from which we can conclude that  $a_1 = b_1$  and  $a_2 = b_2$  because column vectors are equal only when they have equal components.

To check that  $f$  is onto we must prove that any member of the codomain  $\mathbb{R}^2$  is the image of some member of the domain  $G$ . But that’s clear since

$$\begin{pmatrix} x \\ y \end{pmatrix}$$

is the image under  $f$  of  $x \cos \theta + y \sin \theta$ .

Next we will verify condition (2), that  $f$  preserves structure.

---

\*More information on one-to-one and onto maps is in the appendix.

This computation shows that  $f$  preserves addition.

$$\begin{aligned}
 f((a_1 \cos \theta + a_2 \sin \theta) + (b_1 \cos \theta + b_2 \sin \theta)) & \\
 &= f((a_1 + b_1) \cos \theta + (a_2 + b_2) \sin \theta) \\
 &= \begin{pmatrix} a_1 + b_1 \\ a_2 + b_2 \end{pmatrix} \\
 &= \begin{pmatrix} a_1 \\ a_2 \end{pmatrix} + \begin{pmatrix} b_1 \\ b_2 \end{pmatrix} \\
 &= f(a_1 \cos \theta + a_2 \sin \theta) + f(b_1 \cos \theta + b_2 \sin \theta)
 \end{aligned}$$

A similar computation shows that  $f$  preserves scalar multiplication.

$$\begin{aligned}
 f(r \cdot (a_1 \cos \theta + a_2 \sin \theta)) &= f(ra_1 \cos \theta + ra_2 \sin \theta) \\
 &= \begin{pmatrix} ra_1 \\ ra_2 \end{pmatrix} \\
 &= r \cdot \begin{pmatrix} a_1 \\ a_2 \end{pmatrix} \\
 &= r \cdot f(a_1 \cos \theta + a_2 \sin \theta)
 \end{aligned}$$

With that, conditions (1) and (2) are verified, so we know that  $f$  is an isomorphism and we can say that the spaces are isomorphic  $G \cong \mathbb{R}^2$ .

**1.5 Example** Let  $V$  be the space  $\{c_1x + c_2y + c_3z \mid c_1, c_2, c_3 \in \mathbb{R}\}$  of linear combinations of three variables  $x$ ,  $y$ , and  $z$ , under the natural addition and scalar multiplication operations. Then  $V$  is isomorphic to  $\mathcal{P}_2$ , the space of quadratic polynomials.

To show this we will produce an isomorphism map. There is more than one possibility; for instance, here are four.

$$\begin{array}{lcl}
 c_1x + c_2y + c_3z & \xrightarrow{f_1} & c_1 + c_2x + c_3x^2 \\
 & \xrightarrow{f_2} & c_2 + c_3x + c_1x^2 \\
 & \xrightarrow{f_3} & -c_1 - c_2x - c_3x^2 \\
 & \xrightarrow{f_4} & c_1 + (c_1 + c_2)x + (c_1 + c_3)x^2
 \end{array}$$

The first map is the more natural correspondence in that it just carries the coefficients over. However, below we shall verify that the second one is an isomorphism, to underline that there are isomorphisms other than just the obvious one (showing that  $f_1$  is an isomorphism is Exercise 13).

To show that  $f_2$  is one-to-one, we will prove that if  $f_2(c_1x + c_2y + c_3z) = f_2(d_1x + d_2y + d_3z)$  then  $c_1x + c_2y + c_3z = d_1x + d_2y + d_3z$ . The assumption that  $f_2(c_1x + c_2y + c_3z) = f_2(d_1x + d_2y + d_3z)$  gives, by the definition of  $f_2$ , that  $c_2 + c_3x + c_1x^2 = d_2 + d_3x + d_1x^2$ . Equal polynomials have equal coefficients, so  $c_2 = d_2$ ,  $c_3 = d_3$ , and  $c_1 = d_1$ . Therefore  $f_2$  is one-to-one.

The map  $f_2$  is onto because any member  $a + bx + cx^2$  of the codomain is the image of a member of the domain, namely  $cx + ay + bz$ . For instance,  $2 + 3x - 4x^2$  is  $f_2(-4x + 2y + 3z)$ .

The computations for structure preservation are like those in the prior example. This map preserves addition

$$\begin{aligned} f_2((c_1x + c_2y + c_3z) + (d_1x + d_2y + d_3z)) \\ &= f_2((c_1 + d_1)x + (c_2 + d_2)y + (c_3 + d_3)z) \\ &= (c_2 + d_2) + (c_3 + d_3)x + (c_1 + d_1)x^2 \\ &= (c_2 + c_3x + c_1x^2) + (d_2 + d_3x + d_1x^2) \\ &= f_2(c_1x + c_2y + c_3z) + f_2(d_1x + d_2y + d_3z) \end{aligned}$$

and scalar multiplication.

$$\begin{aligned} f_2(r \cdot (c_1x + c_2y + c_3z)) &= f_2(rc_1x + rc_2y + rc_3z) \\ &= rc_2 + rc_3x + rc_1x^2 \\ &= r \cdot (c_2 + c_3x + c_1x^2) \\ &= r \cdot f_2(c_1x + c_2y + c_3z) \end{aligned}$$

Thus  $f_2$  is an isomorphism and we write  $V \cong \mathcal{P}_2$ .

Every space is isomorphic to itself under the identity map.

**1.6 Definition** An *automorphism* is an isomorphism of a space with itself.

**1.7 Example** A *dilation* map  $d_s: \mathbb{R}^2 \rightarrow \mathbb{R}^2$  that multiplies all vectors by a nonzero scalar  $s$  is an automorphism of  $\mathbb{R}^2$ .

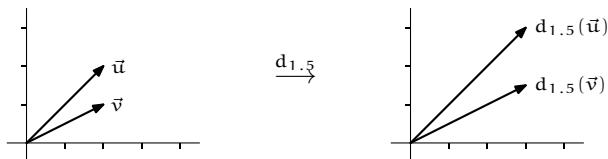

A *rotation* or *turning map*  $t_\theta: \mathbb{R}^2 \rightarrow \mathbb{R}^2$  that rotates all vectors through an angle  $\theta$  is an automorphism.

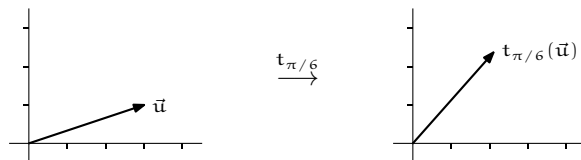

A third type of automorphism of  $\mathbb{R}^2$  is a map  $f_\ell: \mathbb{R}^2 \rightarrow \mathbb{R}^2$  that *flips* or *reflects* all vectors over a line  $\ell$  through the origin.

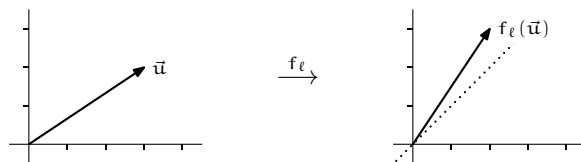

Checking that these are automorphisms is Exercise 30.

**1.8 Example** Consider the space  $\mathcal{P}_5$  of polynomials of degree 5 or less and the map  $f$  that sends a polynomial  $p(x)$  to  $p(x-1)$ . For instance, under this map  $x^2 \mapsto (x-1)^2 = x^2 - 2x + 1$  and  $x^3 + 2x \mapsto (x-1)^3 + 2(x-1) = x^3 - 3x^2 + 5x - 3$ . This map is an automorphism of this space; the check is Exercise 22.

This isomorphism of  $\mathcal{P}_5$  with itself does more than just tell us that the space is “the same” as itself. It gives us some insight into the space’s structure. For instance, below is shown a family of parabolas, graphs of members of  $\mathcal{P}_5$ . Each has a vertex at  $y = -1$ , and the left-most one has zeroes at  $-2.25$  and  $-1.75$ , the next one has zeroes at  $-1.25$  and  $-0.75$ , etc.

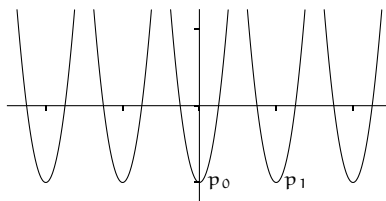

Substitution of  $x - 1$  for  $x$  in any function’s argument shifts its graph to the right by one. Thus,  $f(p_0) = p_1$ . Notice that the picture before  $f$  is applied is the same as the picture after  $f$  is applied because while each parabola moves to the right, another one comes in from the left to take its place. This also holds true for cubics, etc. So the automorphism  $f$  expresses the idea that  $\mathcal{P}_5$  has a certain horizontal-homogeneity, that this space looks the same near  $x = 1$  as near  $x = 0$ .

As described in the opening to this section, having given the definition of isomorphism, we next support the contention that it captures our intuition of vector spaces being the same. Of course, the definition itself is persuasive: a vector space consists of a set and some structure and the definition simply requires that the sets correspond and that the structures corresponds also. Also persuasive are the examples above, such as Example 1.1 giving the isomorphism between the space of two-wide row vectors and the space of two-tall column vectors, which dramatize that isomorphic spaces are the same in all relevant respects. Sometimes people say, where  $V \cong W$ , that “ $W$  is just  $V$  painted green” — differences are merely cosmetic.

The results below further support our contention that under an isomorphism all the things of interest in the two vector spaces correspond. Because we introduced vector spaces to study linear combinations, “of interest” means “pertaining to linear combinations.” Not of interest is the way that the vectors are presented typographically (or their color!).

**1.9 Lemma** An isomorphism maps a zero vector to a zero vector.

**PROOF** Where  $f: V \rightarrow W$  is an isomorphism, fix any  $\vec{v} \in V$ . Then  $f(\vec{0}_V) = f(0 \cdot \vec{v}) = 0 \cdot f(\vec{v}) = \vec{0}_W$ . QED



**1.10 Lemma** For any map  $f: V \rightarrow W$  between vector spaces these statements are equivalent.

(1)  $f$  preserves structure

$$f(\vec{v}_1 + \vec{v}_2) = f(\vec{v}_1) + f(\vec{v}_2) \quad \text{and} \quad f(c\vec{v}) = c f(\vec{v})$$

(2)  $f$  preserves linear combinations of two vectors

$$f(c_1\vec{v}_1 + c_2\vec{v}_2) = c_1 f(\vec{v}_1) + c_2 f(\vec{v}_2)$$

(3)  $f$  preserves linear combinations of any finite number of vectors

$$f(c_1\vec{v}_1 + \cdots + c_n\vec{v}_n) = c_1 f(\vec{v}_1) + \cdots + c_n f(\vec{v}_n)$$

**PROOF** Since the implications (3)  $\implies$  (2) and (2)  $\implies$  (1) are clear, we need only show that (1)  $\implies$  (3). Assume statement (1). We will prove statement (3) by induction on the number of summands  $n$ .

The one-summand base case, that  $f(c\vec{v}_1) = c f(\vec{v}_1)$ , is covered by the assumption of statement (1).

For the inductive step assume that statement (3) holds whenever there are  $k$  or fewer summands, that is, whenever  $n = 1$ , or  $n = 2, \dots$ , or  $n = k$ . Consider the  $k + 1$ -summand case. Use the first half of (1) to breaking the sum along the final '+'.

$$f(c_1\vec{v}_1 + \cdots + c_k\vec{v}_k + c_{k+1}\vec{v}_{k+1}) = f(c_1\vec{v}_1 + \cdots + c_k\vec{v}_k) + f(c_{k+1}\vec{v}_{k+1})$$

Use the inductive hypothesis to break up the  $k$ -term sum on the left.

$$= f(c_1\vec{v}_1) + \cdots + f(c_k\vec{v}_k) + f(c_{k+1}\vec{v}_{k+1})$$

Now the second half of (1) gives

$$= c_1 f(\vec{v}_1) + \cdots + c_k f(\vec{v}_k) + c_{k+1} f(\vec{v}_{k+1})$$

when applied  $k + 1$  times. QED

Using item (2) is a standard way to verify that a map preserves structure.

We close with a summary. In the prior chapter, after giving the definition of a vector space, we looked at examples and some of them seemed to be essentially the same. Here we have defined the relation ' $\cong$ ' and have argued that it is the right way to say precisely what we mean by 'the same' because it preserves the features of interest in a vector space—in particular, it preserves linear combinations. In the next section we will show that isomorphism is an equivalence relation and so partitions the collection of vector spaces into cases.

### Exercises

- ✓ **1.11** Verify, using Example 1.4 as a model, that the two correspondences given before the definition are isomorphisms.

(a) Example 1.1    (b) Example 1.2

✓ 1.12 For the map  $f: \mathcal{P}_1 \rightarrow \mathbb{R}^2$  given by

$$a + bx \mapsto \begin{pmatrix} a - b \\ b \end{pmatrix}$$

Find the image of each of these elements of the domain.

(a)  $3 - 2x$     (b)  $2 + 2x$     (c)  $x$

Show that this map is an isomorphism.

1.13 Show that the natural map  $f_1$  from Example 1.5 is an isomorphism.

✓ 1.14 Decide whether each map is an isomorphism (if it is an isomorphism then prove it and if it isn't then state a condition that it fails to satisfy).

(a)  $f: \mathcal{M}_{2 \times 2} \rightarrow \mathbb{R}$  given by

$$\begin{pmatrix} a & b \\ c & d \end{pmatrix} \mapsto ad - bc$$

(b)  $f: \mathcal{M}_{2 \times 2} \rightarrow \mathbb{R}^4$  given by

$$\begin{pmatrix} a & b \\ c & d \end{pmatrix} \mapsto \begin{pmatrix} a + b + c + d \\ a + b + c \\ a + b \\ a \end{pmatrix}$$

(c)  $f: \mathcal{M}_{2 \times 2} \rightarrow \mathcal{P}_3$  given by

$$\begin{pmatrix} a & b \\ c & d \end{pmatrix} \mapsto c + (d + c)x + (b + a)x^2 + ax^3$$

(d)  $f: \mathcal{M}_{2 \times 2} \rightarrow \mathcal{P}_3$  given by

$$\begin{pmatrix} a & b \\ c & d \end{pmatrix} \mapsto c + (d + c)x + (b + a + 1)x^2 + ax^3$$

1.15 Show that the map  $f: \mathbb{R}^1 \rightarrow \mathbb{R}^1$  given by  $f(x) = x^3$  is one-to-one and onto. Is it an isomorphism?

✓ 1.16 Refer to Example 1.1. Produce two more isomorphisms (of course, you must also verify that they satisfy the conditions in the definition of isomorphism).

1.17 Refer to Example 1.2. Produce two more isomorphisms (and verify that they satisfy the conditions).

✓ 1.18 Show that, although  $\mathbb{R}^2$  is not itself a subspace of  $\mathbb{R}^3$ , it is isomorphic to the  $xy$ -plane subspace of  $\mathbb{R}^3$ .

1.19 Find two isomorphisms between  $\mathbb{R}^{16}$  and  $\mathcal{M}_{4 \times 4}$ .

✓ 1.20 For what  $k$  is  $\mathcal{M}_{m \times n}$  isomorphic to  $\mathbb{R}^k$ ?

1.21 For what  $k$  is  $\mathcal{P}_k$  isomorphic to  $\mathbb{R}^n$ ?

1.22 Prove that the map in Example 1.8, from  $\mathcal{P}_5$  to  $\mathcal{P}_5$  given by  $p(x) \mapsto p(x - 1)$ , is a vector space isomorphism.

1.23 Why, in Lemma 1.9, must there be a  $\vec{v} \in V$ ? That is, why must  $V$  be nonempty?

1.24 Are any two trivial spaces isomorphic?

1.25 In the proof of Lemma 1.10, what about the zero-summands case (that is, if  $n$  is zero)?

1.26 Show that any isomorphism  $f: \mathcal{P}_0 \rightarrow \mathbb{R}^1$  has the form  $a \mapsto ka$  for some nonzero real number  $k$ .

✓ 1.27 These prove that isomorphism is an equivalence relation.

(a) Show that the identity map  $\text{id}: V \rightarrow V$  is an isomorphism. Thus, any vector space is isomorphic to itself.

(b) Show that if  $f: V \rightarrow W$  is an isomorphism then so is its inverse  $f^{-1}: W \rightarrow V$ . Thus, if  $V$  is isomorphic to  $W$  then also  $W$  is isomorphic to  $V$ .

(c) Show that a composition of isomorphisms is an isomorphism: if  $f: V \rightarrow W$  is an isomorphism and  $g: W \rightarrow U$  is an isomorphism then so also is  $g \circ f: V \rightarrow U$ . Thus, if  $V$  is isomorphic to  $W$  and  $W$  is isomorphic to  $U$ , then also  $V$  is isomorphic to  $U$ .

1.28 Suppose that  $f: V \rightarrow W$  preserves structure. Show that  $f$  is one-to-one if and only if the unique member of  $V$  mapped by  $f$  to  $\vec{0}_W$  is  $\vec{0}_V$ .

1.29 Suppose that  $f: V \rightarrow W$  is an isomorphism. Prove that the set  $\{\vec{v}_1, \dots, \vec{v}_k\} \subseteq V$  is linearly dependent if and only if the set of images  $\{f(\vec{v}_1), \dots, f(\vec{v}_k)\} \subseteq W$  is linearly dependent.

✓ 1.30 Show that each type of map from Example 1.7 is an automorphism.

(a) Dilation  $d_s$  by a nonzero scalar  $s$ .

(b) Rotation  $t_\theta$  through an angle  $\theta$ .

(c) Reflection  $f_\ell$  over a line through the origin.

*Hint.* For the second and third items, polar coordinates are useful.

1.31 Produce an automorphism of  $\mathcal{P}_2$  other than the identity map, and other than a shift map  $p(x) \mapsto p(x - k)$ .

1.32 (a) Show that a function  $f: \mathbb{R}^1 \rightarrow \mathbb{R}^1$  is an automorphism if and only if it has the form  $x \mapsto kx$  for some  $k \neq 0$ .

(b) Let  $f$  be an automorphism of  $\mathbb{R}^1$  such that  $f(3) = 7$ . Find  $f(-2)$ .

(c) Show that a function  $f: \mathbb{R}^2 \rightarrow \mathbb{R}^2$  is an automorphism if and only if it has the form

$$\begin{pmatrix} x \\ y \end{pmatrix} \mapsto \begin{pmatrix} ax + by \\ cx + dy \end{pmatrix}$$

for some  $a, b, c, d \in \mathbb{R}$  with  $ad - bc \neq 0$ . *Hint.* Exercises in prior subsections have shown that

$$\begin{pmatrix} b \\ d \end{pmatrix} \text{ is not a multiple of } \begin{pmatrix} a \\ c \end{pmatrix}$$

if and only if  $ad - bc \neq 0$ .

(d) Let  $f$  be an automorphism of  $\mathbb{R}^2$  with

$$f\left(\begin{pmatrix} 1 \\ 3 \end{pmatrix}\right) = \begin{pmatrix} 2 \\ -1 \end{pmatrix} \quad \text{and} \quad f\left(\begin{pmatrix} 1 \\ 4 \end{pmatrix}\right) = \begin{pmatrix} 0 \\ 1 \end{pmatrix}.$$

Find

$$f\left(\begin{pmatrix} 0 \\ -1 \end{pmatrix}\right).$$

1.33 Refer to Lemma 1.9 and Lemma 1.10. Find two more things preserved by isomorphism.

1.34 We show that isomorphisms can be tailored to fit in that, sometimes, given vectors in the domain and in the range we can produce an isomorphism associating those vectors.

(a) Let  $B = \langle \vec{\beta}_1, \vec{\beta}_2, \vec{\beta}_3 \rangle$  be a basis for  $\mathcal{P}_2$  so that any  $\vec{p} \in \mathcal{P}_2$  has a unique representation as  $\vec{p} = c_1\vec{\beta}_1 + c_2\vec{\beta}_2 + c_3\vec{\beta}_3$ , which we denote in this way.

$$\text{Rep}_B(\vec{p}) = \begin{pmatrix} c_1 \\ c_2 \\ c_3 \end{pmatrix}$$

Show that the  $\text{Rep}_B(\cdot)$  operation is a function from  $\mathcal{P}_2$  to  $\mathbb{R}^3$  (this entails showing that with every domain vector  $\vec{v} \in \mathcal{P}_2$  there is an associated image vector in  $\mathbb{R}^3$ , and further, that with every domain vector  $\vec{v} \in \mathcal{P}_2$  there is at most one associated image vector).

- (b) Show that this  $\text{Rep}_B(\cdot)$  function is one-to-one and onto.  
 (c) Show that it preserves structure.  
 (d) Produce an isomorphism from  $\mathcal{P}_2$  to  $\mathbb{R}^3$  that fits these specifications.

$$x + x^2 \mapsto \begin{pmatrix} 1 \\ 0 \\ 0 \end{pmatrix} \quad \text{and} \quad 1 - x \mapsto \begin{pmatrix} 0 \\ 1 \\ 0 \end{pmatrix}$$

**1.35** Prove that a space is  $n$ -dimensional if and only if it is isomorphic to  $\mathbb{R}^n$ . *Hint.* Fix a basis  $B$  for the space and consider the map sending a vector over to its representation with respect to  $B$ .

**1.36** (Requires the subsection on Combining Subspaces, which is optional.) Let  $U$  and  $W$  be vector spaces. Define a new vector space, consisting of the set  $U \times W = \{(\vec{u}, \vec{w}) \mid \vec{u} \in U \text{ and } \vec{w} \in W\}$  along with these operations.

$$(\vec{u}_1, \vec{w}_1) + (\vec{u}_2, \vec{w}_2) = (\vec{u}_1 + \vec{u}_2, \vec{w}_1 + \vec{w}_2) \quad \text{and} \quad r \cdot (\vec{u}, \vec{w}) = (r\vec{u}, r\vec{w})$$

This is a vector space, the *external direct sum* of  $U$  and  $W$ .

- (a) Check that it is a vector space.  
 (b) Find a basis for, and the dimension of, the external direct sum  $\mathcal{P}_2 \times \mathbb{R}^2$ .  
 (c) What is the relationship among  $\dim(U)$ ,  $\dim(W)$ , and  $\dim(U \times W)$ ?  
 (d) Suppose that  $U$  and  $W$  are subspaces of a vector space  $V$  such that  $V = U \oplus W$  (in this case we say that  $V$  is the *internal direct sum* of  $U$  and  $W$ ). Show that the map  $f: U \times W \rightarrow V$  given by

$$(\vec{u}, \vec{w}) \xrightarrow{f} \vec{u} + \vec{w}$$

is an isomorphism. Thus if the internal direct sum is defined then the internal and external direct sums are isomorphic.

## 1.2 Dimension Characterizes Isomorphism

In the prior subsection, after stating the definition of an isomorphism, we gave some results supporting the intuition that such a map describes spaces as “the same.” Here we will develop this intuition. When two spaces that are isomorphic are not equal, we think of them as almost equal, as equivalent. We shall show that the relationship ‘is isomorphic to’ is an equivalence relation.\*

**2.1 Lemma** The inverse of an isomorphism is also an isomorphism.

**PROOF** Suppose that  $V$  is isomorphic to  $W$  via  $f: V \rightarrow W$ . Because an isomorphism is a correspondence,  $f$  has an inverse function  $f^{-1}: W \rightarrow V$  that is also a correspondence.†

To finish we will show that because  $f$  preserves linear combinations, so also

\* More information on equivalence relations and equivalence classes is in the appendix.

† More information on inverse functions is in the appendix.

does  $f^{-1}$ . Let  $\vec{w}_1 = f(\vec{v}_1)$  and  $\vec{w}_2 = f(\vec{v}_2)$

$$\begin{aligned} f^{-1}(c_1 \cdot \vec{w}_1 + c_2 \cdot \vec{w}_2) &= f^{-1}(c_1 \cdot f(\vec{v}_1) + c_2 \cdot f(\vec{v}_2)) \\ &= f^{-1}(f(c_1 \vec{v}_1 + c_2 \vec{v}_2)) \\ &= c_1 \vec{v}_1 + c_2 \vec{v}_2 \\ &= c_1 \cdot f^{-1}(\vec{w}_1) + c_2 \cdot f^{-1}(\vec{w}_2) \end{aligned}$$

since  $f^{-1}(\vec{w}_1) = \vec{v}_1$  and  $f^{-1}(\vec{w}_2) = \vec{v}_2$ . With that, by Lemma 1.10 this map preserves structure. QED

## 2.2 Theorem Isomorphism is an equivalence relation between vector spaces.

**PROOF** We must prove that the relation is symmetric, reflexive, and transitive.

To check reflexivity, that any space is isomorphic to itself, consider the identity map. It is clearly one-to-one and onto. This calculation shows that it also preserves linear combinations.

$$\text{id}(c_1 \cdot \vec{v}_1 + c_2 \cdot \vec{v}_2) = c_1 \vec{v}_1 + c_2 \vec{v}_2 = c_1 \cdot \text{id}(\vec{v}_1) + c_2 \cdot \text{id}(\vec{v}_2)$$

Symmetry, that is  $V$  is isomorphic to  $W$  then also  $W$  is isomorphic to  $V$ , holds by Lemma 2.1.

Finally, we must check transitivity, that if  $V$  is isomorphic to  $W$  and if  $W$  is isomorphic to  $U$  then also  $V$  is isomorphic to  $U$ . Let  $f: V \rightarrow W$  and  $g: W \rightarrow U$  be isomorphisms and consider the composition  $g \circ f: V \rightarrow U$ . The composition of correspondences is a correspondence so we need only check that the composition preserves linear combinations.

$$\begin{aligned} g \circ f(c_1 \cdot \vec{v}_1 + c_2 \cdot \vec{v}_2) &= g(f(c_1 \cdot \vec{v}_1 + c_2 \cdot \vec{v}_2)) \\ &= g(c_1 \cdot f(\vec{v}_1) + c_2 \cdot f(\vec{v}_2)) \\ &= c_1 \cdot g(f(\vec{v}_1)) + c_2 \cdot g(f(\vec{v}_2)) \\ &= c_1 \cdot (g \circ f)(\vec{v}_1) + c_2 \cdot (g \circ f)(\vec{v}_2) \end{aligned}$$

Thus the composition is an isomorphism. QED

Therefore, isomorphism partitions the universe of vector spaces into classes. Every space is in one and only one isomorphism class.

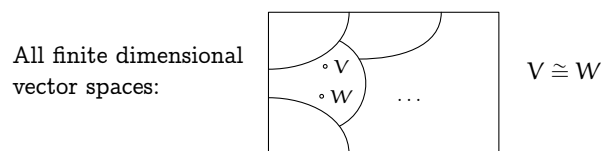

## 2.3 Theorem Vector spaces are isomorphic if and only if they have the same dimension.

We've broken the proof into two halves.

**2.4 Lemma** If spaces are isomorphic then they have the same dimension.

**PROOF** We shall show that an isomorphism of two spaces gives a correspondence between their bases. That is, we shall show that if  $f: V \rightarrow W$  is an isomorphism and a basis for the domain  $V$  is  $B = \langle \vec{\beta}_1, \dots, \vec{\beta}_n \rangle$ , then the image set  $D = \langle f(\vec{\beta}_1), \dots, f(\vec{\beta}_n) \rangle$  is a basis for the codomain  $W$ . The other half of the correspondence—that for any basis of  $W$  the inverse image is a basis for  $V$ —follows from Lemma 2.1, that if  $f$  is an isomorphism then  $f^{-1}$  is also an isomorphism, and applying the prior sentence to  $f^{-1}$ .

To see that  $D$  spans  $W$ , fix any  $\vec{w} \in W$ , note that  $f$  is onto and so there is a  $\vec{v} \in V$  with  $\vec{w} = f(\vec{v})$ , and expand  $\vec{v}$  as a combination of basis vectors.

$$\vec{w} = f(\vec{v}) = f(v_1 \vec{\beta}_1 + \dots + v_n \vec{\beta}_n) = v_1 \cdot f(\vec{\beta}_1) + \dots + v_n \cdot f(\vec{\beta}_n)$$

For linear independence of  $D$ , if

$$\vec{0}_W = c_1 f(\vec{\beta}_1) + \dots + c_n f(\vec{\beta}_n) = f(c_1 \vec{\beta}_1 + \dots + c_n \vec{\beta}_n)$$

then, since  $f$  is one-to-one and so the only vector sent to  $\vec{0}_W$  is  $\vec{0}_V$ , we have that  $\vec{0}_V = c_1 \vec{\beta}_1 + \dots + c_n \vec{\beta}_n$ , implying that all of the  $c$ 's are zero. QED

**2.5 Lemma** If spaces have the same dimension then they are isomorphic.

**PROOF** We will prove that any space of dimension  $n$  is isomorphic to  $\mathbb{R}^n$ . Then we will have that all such spaces are isomorphic to each other by transitivity, which was shown in Theorem 2.2.

Let  $V$  be  $n$ -dimensional. Fix a basis  $B = \langle \vec{\beta}_1, \dots, \vec{\beta}_n \rangle$  for the domain  $V$ . Consider the operation of representing the members of  $V$  with respect to  $B$  as a function from  $V$  to  $\mathbb{R}^n$

$$\vec{v} = v_1 \vec{\beta}_1 + \dots + v_n \vec{\beta}_n \xrightarrow{\text{Rep}_B} \begin{pmatrix} v_1 \\ \vdots \\ v_n \end{pmatrix}$$

(it is well-defined\* since every  $\vec{v}$  has one and only one such representation—see Remark 2.6 below).

This function is one-to-one because if

$$\text{Rep}_B(u_1 \vec{\beta}_1 + \dots + u_n \vec{\beta}_n) = \text{Rep}_B(v_1 \vec{\beta}_1 + \dots + v_n \vec{\beta}_n)$$

then

$$\begin{pmatrix} u_1 \\ \vdots \\ u_n \end{pmatrix} = \begin{pmatrix} v_1 \\ \vdots \\ v_n \end{pmatrix}$$

---

\* More information on well-defined is in the appendix.

and so  $u_1 = v_1, \dots, u_n = v_n$ , implying that the original arguments  $u_1\vec{\beta}_1 + \dots + u_n\vec{\beta}_n$  and  $v_1\vec{\beta}_1 + \dots + v_n\vec{\beta}_n$  are equal.

This function is onto; any member of  $\mathbb{R}^n$

$$\vec{w} = \begin{pmatrix} w_1 \\ \vdots \\ w_n \end{pmatrix}$$

is the image of some  $\vec{v} \in V$ , namely  $\vec{w} = \text{Rep}_B(w_1\vec{\beta}_1 + \dots + w_n\vec{\beta}_n)$ .

Finally, this function preserves structure.

$$\begin{aligned} \text{Rep}_B(r \cdot \vec{u} + s \cdot \vec{v}) &= \text{Rep}_B((ru_1 + sv_1)\vec{\beta}_1 + \dots + (ru_n + sv_n)\vec{\beta}_n) \\ &= \begin{pmatrix} ru_1 + sv_1 \\ \vdots \\ ru_n + sv_n \end{pmatrix} \\ &= r \cdot \begin{pmatrix} u_1 \\ \vdots \\ u_n \end{pmatrix} + s \cdot \begin{pmatrix} v_1 \\ \vdots \\ v_n \end{pmatrix} \\ &= r \cdot \text{Rep}_B(\vec{u}) + s \cdot \text{Rep}_B(\vec{v}) \end{aligned}$$

Thus, the  $\text{Rep}_B$  function is an isomorphism and therefore any  $n$ -dimensional space is isomorphic to  $\mathbb{R}^n$ . QED

**2.6 Remark** The parenthetical comment in that proof about the role played by the ‘one and only one representation’ result can do with some amplification. A contrasting example, where an association doesn’t have this property, will help illuminate the issue. Consider this subset of  $\mathcal{P}_2$ , which is not a basis.

$$A = \{1 + 0x + 0x^2, 0 + 1x + 0x^2, 0 + 0x + 1x^2, 1 + 1x + 2x^2\}$$

Call those polynomials  $\vec{\alpha}_1, \dots, \vec{\alpha}_4$ . If, as in the proof, we try to write the members of  $\mathcal{P}_2$  as  $\vec{p} = c_1\vec{\alpha}_1 + c_2\vec{\alpha}_2 + c_3\vec{\alpha}_3 + c_4\vec{\alpha}_4$  in order to associate  $\vec{p}$  with the 4-tall vector with components  $c_1, \dots, c_4$  then we have a problem. For, consider  $\vec{p}(x) = 1 + x + x^2$ . Both

$$\vec{p}(x) = 1\vec{\alpha}_1 + 1\vec{\alpha}_2 + 1\vec{\alpha}_3 + 0\vec{\alpha}_4 \quad \text{and} \quad \vec{p}(x) = 0\vec{\alpha}_1 + 0\vec{\alpha}_2 - 1\vec{\alpha}_3 + 1\vec{\alpha}_4$$

so we are trying to associate  $\vec{p}$  with more than one 4-tall vector

$$\begin{pmatrix} 1 \\ 1 \\ 1 \\ 0 \end{pmatrix} \quad \text{and} \quad \begin{pmatrix} 0 \\ 0 \\ -1 \\ 1 \end{pmatrix}$$

(of course,  $\vec{p}$ ’s decomposition is not unique because  $A$  is not linearly independent). That is, the input  $\vec{p}$  is not associated with a well-defined — i.e., unique — output value.

In general, any time that we define a function we must check that output values are well-defined. In the above proof we must check that for a fixed  $B$  each vector in the domain is associated by  $\text{Rep}_B$  with one and only one vector in the codomain. That check is Exercise 19.

We say that the isomorphism classes are *characterized* by dimension because we can describe each class simply by giving the number that is the dimension of all of the spaces in that class.

**2.7 Corollary** A finite-dimensional vector space is isomorphic to one and only one of the  $\mathbb{R}^n$ .

This gives us a collection of representatives of the isomorphism classes.

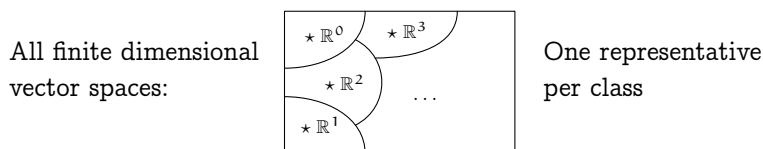

The proofs above pack many ideas into a small space. Through the rest of this chapter we'll consider these ideas again, and fill them out. For a taste of this, we will expand here on the proof of Lemma 2.5.

**2.8 Example** The space  $\mathcal{M}_{2 \times 2}$  of  $2 \times 2$  matrices is isomorphic to  $\mathbb{R}^4$ . With this basis for the domain

$$B = \left\langle \begin{pmatrix} 1 & 0 \\ 0 & 0 \end{pmatrix}, \begin{pmatrix} 0 & 1 \\ 0 & 0 \end{pmatrix}, \begin{pmatrix} 0 & 0 \\ 1 & 0 \end{pmatrix}, \begin{pmatrix} 0 & 0 \\ 0 & 1 \end{pmatrix} \right\rangle$$

the isomorphism given in the lemma, the representation map  $f_1 = \text{Rep}_B$ , carries the entries over.

$$\begin{pmatrix} a & b \\ c & d \end{pmatrix} \xrightarrow{f_1} \begin{pmatrix} a \\ b \\ c \\ d \end{pmatrix}$$

One way to think of the map  $f_1$  is: fix the basis  $B$  for the domain and the basis  $\mathcal{E}_4$  for the codomain, and associate  $\vec{\beta}_1$  with  $\vec{e}_1$ , and  $\vec{\beta}_2$  with  $\vec{e}_2$ , etc. Then extend this association to all of the members of two spaces.

$$\begin{pmatrix} a & b \\ c & d \end{pmatrix} = a\vec{\beta}_1 + b\vec{\beta}_2 + c\vec{\beta}_3 + d\vec{\beta}_4 \xrightarrow{f_1} a\vec{e}_1 + b\vec{e}_2 + c\vec{e}_3 + d\vec{e}_4 = \begin{pmatrix} a \\ b \\ c \\ d \end{pmatrix}$$

We say that the map has been *extended linearly* from the bases to the spaces.

We can do the same thing with different bases, for instance, taking this basis for the domain.

$$A = \left\langle \begin{pmatrix} 2 & 0 \\ 0 & 0 \end{pmatrix}, \begin{pmatrix} 0 & 2 \\ 0 & 0 \end{pmatrix}, \begin{pmatrix} 0 & 0 \\ 2 & 0 \end{pmatrix}, \begin{pmatrix} 0 & 0 \\ 0 & 2 \end{pmatrix} \right\rangle$$



Associating corresponding members of  $A$  and  $\mathcal{E}_4$  and extending linearly

$$\begin{pmatrix} a & b \\ c & d \end{pmatrix} = (a/2)\vec{\alpha}_1 + (b/2)\vec{\alpha}_2 + (c/2)\vec{\alpha}_3 + (d/2)\vec{\alpha}_4$$

$$\xrightarrow{f_2} (a/2)\vec{e}_1 + (b/2)\vec{e}_2 + (c/2)\vec{e}_3 + (d/2)\vec{e}_4 = \begin{pmatrix} a/2 \\ b/2 \\ c/2 \\ d/2 \end{pmatrix}$$

gives rise to an isomorphism that is different than  $f_1$ .

The prior map arose by changing the basis for the domain. We can also change the basis for the codomain. Starting with

$$B \quad \text{and} \quad D = \left\langle \begin{pmatrix} 1 \\ 0 \\ 0 \\ 0 \end{pmatrix}, \begin{pmatrix} 0 \\ 1 \\ 0 \\ 0 \end{pmatrix}, \begin{pmatrix} 0 \\ 0 \\ 1 \\ 0 \end{pmatrix}, \begin{pmatrix} 0 \\ 0 \\ 0 \\ 1 \end{pmatrix} \right\rangle$$

associating  $\vec{\beta}_1$  with  $\vec{\delta}_1$ , etc., and then linearly extending that correspondence to all of the two spaces

$$\begin{pmatrix} a & b \\ c & d \end{pmatrix} = a\vec{\beta}_1 + b\vec{\beta}_2 + c\vec{\beta}_3 + d\vec{\beta}_4 \xrightarrow{f_3} a\vec{\delta}_1 + b\vec{\delta}_2 + c\vec{\delta}_3 + d\vec{\delta}_4 = \begin{pmatrix} a \\ b \\ d \\ c \end{pmatrix}$$

gives still another isomorphism.

We close this section with a summary. Recall that in the first chapter we defined two matrices as row equivalent if they can be derived from each other by elementary row operations. We showed that is an equivalence relation and so the collection of matrices is partitioned into classes, where all the matrices that are row equivalent fall together into a single class. Then, for insight into which matrices are in each class, we gave representatives for the classes, the reduced echelon form matrices.

In this section we have followed that outline, except that the appropriate notion of sameness here is vector space isomorphism. First we defined isomorphism, saw some examples, and established some properties. As before, we developed a list of class representatives to help us understand the partition. It is just a classification of spaces by dimension.

In the second chapter, with the definition of vector spaces, we seemed to have opened up our studies to many examples of new structures besides the familiar  $\mathbb{R}^n$ 's. We now know that isn't the case. Any finite-dimensional vector space is actually "the same" as a real space. We are thus considering exactly the structures that we need to consider.

### Exercises

- ✓ 2.9 Decide if the spaces are isomorphic.

- (a)  $\mathbb{R}^2, \mathbb{R}^4$    (b)  $\mathcal{P}_5, \mathbb{R}^5$    (c)  $\mathcal{M}_{2 \times 3}, \mathbb{R}^6$    (d)  $\mathcal{P}_5, \mathcal{M}_{2 \times 3}$   
 (e)  $\mathcal{M}_{2 \times k}, \mathbb{C}^k$
- ✓ 2.10 Consider the isomorphism  $\text{Rep}_B(\cdot): \mathcal{P}_1 \rightarrow \mathbb{R}^2$  where  $B = \langle 1, 1 + x \rangle$ . Find the image of each of these elements of the domain.  
 (a)  $3 - 2x$ ;   (b)  $2 + 2x$ ;   (c)  $x$
- ✓ 2.11 Show that if  $m \neq n$  then  $\mathbb{R}^m \not\cong \mathbb{R}^n$ .
- ✓ 2.12 Is  $\mathcal{M}_{m \times n} \cong \mathcal{M}_{n \times m}$ ?
- ✓ 2.13 Are any two planes through the origin in  $\mathbb{R}^3$  isomorphic?
- 2.14 Find a set of equivalence class representatives other than the set of  $\mathbb{R}^n$ 's.
- 2.15 True or false: between any  $n$ -dimensional space and  $\mathbb{R}^n$  there is exactly one isomorphism.
- 2.16 Can a vector space be isomorphic to one of its (proper) subspaces?
- ✓ 2.17 This subsection shows that for any isomorphism, the inverse map is also an isomorphism. This subsection also shows that for a fixed basis  $B$  of an  $n$ -dimensional vector space  $V$ , the map  $\text{Rep}_B: V \rightarrow \mathbb{R}^n$  is an isomorphism. Find the inverse of this map.
- ✓ 2.18 Prove these facts about matrices.  
 (a) The row space of a matrix is isomorphic to the column space of its transpose.  
 (b) The row space of a matrix is isomorphic to its column space.
- 2.19 Show that the function from Theorem 2.3 is well-defined.
- 2.20 Is the proof of Theorem 2.3 valid when  $n = 0$ ?
- 2.21 For each, decide if it is a set of isomorphism class representatives.  
 (a)  $\{\mathbb{C}^k \mid k \in \mathbb{N}\}$   
 (b)  $\{\mathcal{P}_k \mid k \in \{-1, 0, 1, \dots\}\}$   
 (c)  $\{\mathcal{M}_{m \times n} \mid m, n \in \mathbb{N}\}$
- 2.22 Let  $f$  be a correspondence between vector spaces  $V$  and  $W$  (that is, a map that is one-to-one and onto). Show that the spaces  $V$  and  $W$  are isomorphic via  $f$  if and only if there are bases  $B \subset V$  and  $D \subset W$  such that corresponding vectors have the same coordinates:  $\text{Rep}_B(\vec{v}) = \text{Rep}_D(f(\vec{v}))$ .
- 2.23 Consider the isomorphism  $\text{Rep}_B: \mathcal{P}_3 \rightarrow \mathbb{R}^4$ .  
 (a) Vectors in a real space are orthogonal if and only if their dot product is zero. Give a definition of orthogonality for polynomials.  
 (b) The derivative of a member of  $\mathcal{P}_3$  is in  $\mathcal{P}_3$ . Give a definition of the derivative of a vector in  $\mathbb{R}^4$ .
- ✓ 2.24 Does every correspondence between bases, when extended to the spaces, give an isomorphism?
- 2.25 (Requires the subsection on Combining Subspaces, which is optional.) Suppose that  $V = V_1 \oplus V_2$  and that  $V$  is isomorphic to the space  $U$  under the map  $f$ . Show that  $U = f(V_1) \oplus f(V_2)$ .
- 2.26 Show that this is not a well-defined function from the rational numbers to the integers: with each fraction, associate the value of its numerator.

## II Homomorphisms

The definition of isomorphism has two conditions. In this section we will consider the second one. We will study maps that are required only to preserve structure, maps that are not also required to be correspondences.

Experience shows that these maps are tremendously useful. For one thing we shall see in the second subsection below that while isomorphisms describe how spaces are the same, we can think of these maps as describe how spaces are alike.

### II.1 Definition

**1.1 Definition** A function between vector spaces  $h: V \rightarrow W$  that preserves the operations of addition

$$\text{if } \vec{v}_1, \vec{v}_2 \in V \text{ then } h(\vec{v}_1 + \vec{v}_2) = h(\vec{v}_1) + h(\vec{v}_2)$$

and scalar multiplication

$$\text{if } \vec{v} \in V \text{ and } r \in \mathbb{R} \text{ then } h(r \cdot \vec{v}) = r \cdot h(\vec{v})$$

is a *homomorphism* or *linear map*.

**1.2 Example** The projection map  $\pi: \mathbb{R}^3 \rightarrow \mathbb{R}^2$

$$\begin{pmatrix} x \\ y \\ z \end{pmatrix} \xrightarrow{\pi} \begin{pmatrix} x \\ y \end{pmatrix}$$

is a homomorphism. It preserves addition

$$\pi\left(\begin{pmatrix} x_1 \\ y_1 \\ z_1 \end{pmatrix} + \begin{pmatrix} x_2 \\ y_2 \\ z_2 \end{pmatrix}\right) = \pi\left(\begin{pmatrix} x_1 + x_2 \\ y_1 + y_2 \\ z_1 + z_2 \end{pmatrix}\right) = \begin{pmatrix} x_1 + x_2 \\ y_1 + y_2 \end{pmatrix} = \pi\left(\begin{pmatrix} x_1 \\ y_1 \\ z_1 \end{pmatrix}\right) + \pi\left(\begin{pmatrix} x_2 \\ y_2 \\ z_2 \end{pmatrix}\right)$$

and scalar multiplication.

$$\pi\left(r \cdot \begin{pmatrix} x_1 \\ y_1 \\ z_1 \end{pmatrix}\right) = \pi\left(\begin{pmatrix} rx_1 \\ ry_1 \\ rz_1 \end{pmatrix}\right) = \begin{pmatrix} rx_1 \\ ry_1 \end{pmatrix} = r \cdot \pi\left(\begin{pmatrix} x_1 \\ y_1 \\ z_1 \end{pmatrix}\right)$$

This is not an isomorphism since it is not one-to-one. For instance, both  $\vec{0}$  and  $\vec{e}_3$  in  $\mathbb{R}^3$  map to the zero vector in  $\mathbb{R}^2$ .

**1.3 Example** Of course, the domain and codomain can be other than spaces of column vectors. Both of these are homomorphisms; the verifications are straightforward.

(1)  $f_1: \mathcal{P}_2 \rightarrow \mathcal{P}_3$  given by

$$a_0 + a_1x + a_2x^2 \mapsto a_0x + (a_1/2)x^2 + (a_2/3)x^3$$

(2)  $f_2: M_{2 \times 2} \rightarrow \mathbb{R}$  given by

$$\begin{pmatrix} a & b \\ c & d \end{pmatrix} \mapsto a + d$$

**1.4 Example** Between any two spaces there is a *zero homomorphism*, mapping every vector in the domain to the zero vector in the codomain.

**1.5 Example** These two suggest why we use the term ‘linear map’.

(1) The map  $g: \mathbb{R}^3 \rightarrow \mathbb{R}$  given by

$$\begin{pmatrix} x \\ y \\ z \end{pmatrix} \xrightarrow{g} 3x + 2y - 4.5z$$

is linear, that is, is a homomorphism. In contrast, the map  $\hat{g}: \mathbb{R}^3 \rightarrow \mathbb{R}$  given by

$$\begin{pmatrix} x \\ y \\ z \end{pmatrix} \xrightarrow{\hat{g}} 3x + 2y - 4.5z + 1$$

is not.

$$\hat{g}\left(\begin{pmatrix} 0 \\ 0 \\ 0 \end{pmatrix} + \begin{pmatrix} 1 \\ 0 \\ 0 \end{pmatrix}\right) = 4 \quad \hat{g}\left(\begin{pmatrix} 0 \\ 0 \\ 0 \end{pmatrix}\right) + \hat{g}\left(\begin{pmatrix} 1 \\ 0 \\ 0 \end{pmatrix}\right) = 5$$

To show that a map is not linear we need only produce a single linear combination that the map does not preserve.

(2) The first of these two maps  $t_1, t_2: \mathbb{R}^3 \rightarrow \mathbb{R}^2$  is linear while the second is not.

$$\begin{pmatrix} x \\ y \\ z \end{pmatrix} \xrightarrow{t_1} \begin{pmatrix} 5x - 2y \\ x + y \end{pmatrix} \quad \begin{pmatrix} x \\ y \\ z \end{pmatrix} \xrightarrow{t_2} \begin{pmatrix} 5x - 2y \\ xy \end{pmatrix}$$

Finding a linear combination that the second map does not preserve is easy.

The homomorphisms have coordinate functions that are linear combinations of the arguments.

Any isomorphism is a homomorphism, since an isomorphism is a homomorphism that is also a correspondence. So one way to think of ‘homomorphism’ is as a generalization of ‘isomorphism’ motivated by the observation that many of the properties of isomorphisms have only to do with the map’s structure

preservation property and not to do with being a correspondence. The next two results are examples of that thinking. The proof for each given in the prior section does not use one-to-one-ness or onto-ness and therefore applies here.

**1.6 Lemma** A homomorphism sends a zero vector to a zero vector.

**1.7 Lemma** For any map  $f: V \rightarrow W$  between vector spaces, the following are equivalent.

- (1)  $f$  is a homomorphism
- (2)  $f(c_1 \cdot \vec{v}_1 + c_2 \cdot \vec{v}_2) = c_1 \cdot f(\vec{v}_1) + c_2 \cdot f(\vec{v}_2)$  for any  $c_1, c_2 \in \mathbb{R}$  and  $\vec{v}_1, \vec{v}_2 \in V$
- (3)  $f(c_1 \cdot \vec{v}_1 + \cdots + c_n \cdot \vec{v}_n) = c_1 \cdot f(\vec{v}_1) + \cdots + c_n \cdot f(\vec{v}_n)$  for any  $c_1, \dots, c_n \in \mathbb{R}$  and  $\vec{v}_1, \dots, \vec{v}_n \in V$

**1.8 Example** The function  $f: \mathbb{R}^2 \rightarrow \mathbb{R}^4$  given by

$$\begin{pmatrix} x \\ y \end{pmatrix} \xrightarrow{f} \begin{pmatrix} x/2 \\ 0 \\ x+y \\ 3y \end{pmatrix}$$

is linear since it satisfies item (2).

$$\begin{pmatrix} r_1(x_1/2) + r_2(x_2/2) \\ 0 \\ r_1(x_1 + y_1) + r_2(x_2 + y_2) \\ r_1(3y_1) + r_2(3y_2) \end{pmatrix} = r_1 \begin{pmatrix} x_1/2 \\ 0 \\ x_1 + y_1 \\ 3y_1 \end{pmatrix} + r_2 \begin{pmatrix} x_2/2 \\ 0 \\ x_2 + y_2 \\ 3y_2 \end{pmatrix}$$

However, some of the things that we have seen for isomorphisms fail to hold for homomorphisms in general. One example is the proof of Lemma I.2.4, which shows that an isomorphism between spaces gives a correspondence between their bases. Homomorphisms do not give any such correspondence; Example 1.2 shows this and another example is the zero map between two nontrivial spaces. Instead, for homomorphisms a weaker but still very useful result holds.

**1.9 Theorem** A homomorphism is determined by its action on a basis: if  $\langle \vec{\beta}_1, \dots, \vec{\beta}_n \rangle$  is a basis of a vector space  $V$  and  $\vec{w}_1, \dots, \vec{w}_n$  are elements of a vector space  $W$  (perhaps not distinct elements) then there exists a homomorphism from  $V$  to  $W$  sending each  $\vec{\beta}_i$  to  $\vec{w}_i$ , and that homomorphism is unique.

**PROOF** We will define the map by associating  $\vec{\beta}_i$  with  $\vec{w}_i$  and then extending linearly to all of the domain. That is, given the input  $\vec{v}$ , we find its coordinates with respect to the basis  $\vec{v} = c_1 \vec{\beta}_1 + \cdots + c_n \vec{\beta}_n$  and define the associated output by using the same  $c_i$  coordinates  $h(\vec{v}) = c_1 \vec{w}_1 + \cdots + c_n \vec{w}_n$ . This is a well-defined function because, with respect to the basis, the representation of each domain vector  $\vec{v}$  is unique.

This map is a homomorphism since it preserves linear combinations; where  $\vec{v}_1 = c_1\vec{\beta}_1 + \cdots + c_n\vec{\beta}_n$  and  $\vec{v}_2 = d_1\vec{\beta}_1 + \cdots + d_n\vec{\beta}_n$ , we have this.

$$\begin{aligned} h(r_1\vec{v}_1 + r_2\vec{v}_2) &= h((r_1c_1 + r_2d_1)\vec{\beta}_1 + \cdots + (r_1c_n + r_2d_n)\vec{\beta}_n) \\ &= (r_1c_1 + r_2d_1)\vec{w}_1 + \cdots + (r_1c_n + r_2d_n)\vec{w}_n \\ &= r_1h(\vec{v}_1) + r_2h(\vec{v}_2) \end{aligned}$$

And, this map is unique since if  $\hat{h}: V \rightarrow W$  is another homomorphism satisfying that  $\hat{h}(\vec{\beta}_i) = \vec{w}_i$  for each  $i$  then  $h$  and  $\hat{h}$  agree on all of the vectors in the domain.

$$\begin{aligned} \hat{h}(\vec{v}) &= \hat{h}(c_1\vec{\beta}_1 + \cdots + c_n\vec{\beta}_n) = c_1\hat{h}(\vec{\beta}_1) + \cdots + c_n\hat{h}(\vec{\beta}_n) \\ &= c_1\vec{w}_1 + \cdots + c_n\vec{w}_n = h(\vec{v}) \end{aligned}$$

Thus,  $h$  and  $\hat{h}$  are the same map. QED

**1.10 Example** If we specify a map  $h: \mathbb{R}^2 \rightarrow \mathbb{R}^2$  that acts on the standard basis  $\mathcal{E}_2$  in this way

$$h\left(\begin{pmatrix} 1 \\ 0 \end{pmatrix}\right) = \begin{pmatrix} -1 \\ 1 \end{pmatrix} \quad h\left(\begin{pmatrix} 0 \\ 1 \end{pmatrix}\right) = \begin{pmatrix} -4 \\ 4 \end{pmatrix}$$

then we have also specified the action of  $h$  on any other member of the domain. For instance, the value of  $h$  on this argument

$$h\left(\begin{pmatrix} 3 \\ -2 \end{pmatrix}\right) = h\left(3 \cdot \begin{pmatrix} 1 \\ 0 \end{pmatrix} - 2 \cdot \begin{pmatrix} 0 \\ 1 \end{pmatrix}\right) = 3 \cdot h\left(\begin{pmatrix} 1 \\ 0 \end{pmatrix}\right) - 2 \cdot h\left(\begin{pmatrix} 0 \\ 1 \end{pmatrix}\right) = \begin{pmatrix} 5 \\ -5 \end{pmatrix}$$

is a direct consequence of the value of  $h$  on the basis vectors.

So we can construct a homomorphism by selecting a basis for the domain and specifying where the map sends those basis vectors. The prior lemma shows that we can always extend the action on the map linearly to the entire domain. Later in this chapter we shall develop a convenient scheme for computations like this one, using matrices.

Just as the isomorphisms of a space with itself are useful and interesting, so too are the homomorphisms of a space with itself.

**1.11 Definition** A linear map from a space into itself  $t: V \rightarrow V$  is a *linear transformation*.

**1.12 Remark** In this book we use ‘linear transformation’ only in the case where the codomain equals the domain but it is often used instead as a synonym for ‘homomorphism’.

**1.13 Example** The map on  $\mathbb{R}^2$  that projects all vectors down to the  $x$ -axis

$$\begin{pmatrix} x \\ y \end{pmatrix} \mapsto \begin{pmatrix} x \\ 0 \end{pmatrix}$$

is a linear transformation.

**1.14 Example** The derivative map  $d/dx: \mathcal{P}_n \rightarrow \mathcal{P}_n$

$$a_0 + a_1x + \cdots + a_nx^n \xrightarrow{d/dx} a_1 + 2a_2x + 3a_3x^2 + \cdots + na_nx^{n-1}$$

is a linear transformation as this result from calculus shows:  $d(c_1f + c_2g)/dx = c_1(df/dx) + c_2(dg/dx)$ .

**1.15 Example** The matrix transpose operation

$$\begin{pmatrix} a & b \\ c & d \end{pmatrix} \mapsto \begin{pmatrix} a & c \\ b & d \end{pmatrix}$$

is a linear transformation of  $\mathcal{M}_{2 \times 2}$ . (Transpose is one-to-one and onto and so in fact it is an automorphism.)

We finish this subsection about maps by recalling that we can linearly combine maps. For instance, for these maps from  $\mathbb{R}^2$  to itself

$$\begin{pmatrix} x \\ y \end{pmatrix} \xrightarrow{f} \begin{pmatrix} 2x \\ 3x - 2y \end{pmatrix} \quad \text{and} \quad \begin{pmatrix} x \\ y \end{pmatrix} \xrightarrow{g} \begin{pmatrix} 0 \\ 5x \end{pmatrix}$$

the linear combination  $5f - 2g$  is also a map from  $\mathbb{R}^2$  to itself.

$$\begin{pmatrix} x \\ y \end{pmatrix} \xrightarrow{5f-2g} \begin{pmatrix} 10x \\ 5x - 10y \end{pmatrix}$$

**1.16 Lemma** For vector spaces  $V$  and  $W$ , the set of linear functions from  $V$  to  $W$  is itself a vector space, a subspace of the space of all functions from  $V$  to  $W$ .

We denote the space of linear maps with  $\mathcal{L}(V, W)$ .

**PROOF** This set is non-empty because it contains the zero homomorphism. So to show that it is a subspace we need only check that it is closed under linear combinations. Let  $f, g: V \rightarrow W$  be linear. Then the sum of the two is linear

$$\begin{aligned} (f + g)(c_1\vec{v}_1 + c_2\vec{v}_2) &= f(c_1\vec{v}_1 + c_2\vec{v}_2) + g(c_1\vec{v}_1 + c_2\vec{v}_2) \\ &= c_1f(\vec{v}_1) + c_2f(\vec{v}_2) + c_1g(\vec{v}_1) + c_2g(\vec{v}_2) \\ &= c_1(f + g)(\vec{v}_1) + c_2(f + g)(\vec{v}_2) \end{aligned}$$

and any scalar multiple of a map is also linear.

$$\begin{aligned} (r \cdot f)(c_1\vec{v}_1 + c_2\vec{v}_2) &= r(c_1f(\vec{v}_1) + c_2f(\vec{v}_2)) \\ &= c_1(r \cdot f)(\vec{v}_1) + c_2(r \cdot f)(\vec{v}_2) \end{aligned}$$

Hence  $\mathcal{L}(V, W)$  is a subspace. QED

We started this section by defining homomorphisms as a generalization of isomorphisms, isolating the structure preservation property. Some of the properties of isomorphisms carried over unchanged while we adapted others.

However, if we thereby get an impression that the idea of ‘homomorphism’ is in some way secondary to that of ‘isomorphism’ then that is mistaken. In the rest of this chapter we shall work mostly with homomorphisms. This is partly because any statement made about homomorphisms is automatically true about isomorphisms but more because, while the isomorphism concept is more natural, experience shows that the homomorphism concept is more fruitful and more central to further progress.

### Exercises

✓ **1.17** Decide if each  $h: \mathbb{R}^3 \rightarrow \mathbb{R}^2$  is linear.

$$\begin{aligned} \text{(a)} \quad h\left(\begin{pmatrix} x \\ y \\ z \end{pmatrix}\right) &= \begin{pmatrix} x \\ x+y+z \end{pmatrix} & \text{(b)} \quad h\left(\begin{pmatrix} x \\ y \\ z \end{pmatrix}\right) &= \begin{pmatrix} 0 \\ 0 \end{pmatrix} & \text{(c)} \quad h\left(\begin{pmatrix} x \\ y \\ z \end{pmatrix}\right) &= \begin{pmatrix} 1 \\ 1 \end{pmatrix} \\ \text{(d)} \quad h\left(\begin{pmatrix} x \\ y \\ z \end{pmatrix}\right) &= \begin{pmatrix} 2x+y \\ 3y-4z \end{pmatrix} \end{aligned}$$

✓ **1.18** Decide if each map  $h: \mathcal{M}_{2 \times 2} \rightarrow \mathbb{R}$  is linear.

$$\begin{aligned} \text{(a)} \quad h\left(\begin{pmatrix} a & b \\ c & d \end{pmatrix}\right) &= a + d \\ \text{(b)} \quad h\left(\begin{pmatrix} a & b \\ c & d \end{pmatrix}\right) &= ad - bc \\ \text{(c)} \quad h\left(\begin{pmatrix} a & b \\ c & d \end{pmatrix}\right) &= 2a + 3b + c - d \\ \text{(d)} \quad h\left(\begin{pmatrix} a & b \\ c & d \end{pmatrix}\right) &= a^2 + b^2 \end{aligned}$$

✓ **1.19** Show that these two maps are homomorphisms.

(a)  $d/dx: \mathcal{P}_3 \rightarrow \mathcal{P}_2$  given by  $a_0 + a_1x + a_2x^2 + a_3x^3$  maps to  $a_1 + 2a_2x + 3a_3x^2$

(b)  $\int: \mathcal{P}_2 \rightarrow \mathcal{P}_3$  given by  $b_0 + b_1x + b_2x^2$  maps to  $b_0x + (b_1/2)x^2 + (b_2/3)x^3$

Are these maps inverse to each other?

**1.20** Is (perpendicular) projection from  $\mathbb{R}^3$  to the  $xz$ -plane a homomorphism? Projection to the  $yz$ -plane? To the  $x$ -axis? The  $y$ -axis? The  $z$ -axis? Projection to the origin?

**1.21** Show that, while the maps from Example 1.3 preserve linear operations, they are not isomorphisms.

**1.22** Is an identity map a linear transformation?

✓ **1.23** Stating that a function is ‘linear’ is different than stating that its graph is a line.

(a) The function  $f_1: \mathbb{R} \rightarrow \mathbb{R}$  given by  $f_1(x) = 2x - 1$  has a graph that is a line. Show that it is not a linear function.

(b) The function  $f_2: \mathbb{R}^2 \rightarrow \mathbb{R}$  given by

$$\begin{pmatrix} x \\ y \end{pmatrix} \mapsto x + 2y$$

does not have a graph that is a line. Show that it is a linear function.

✓ **1.24** Part of the definition of a linear function is that it respects addition. Does a linear function respect subtraction?

**1.25** Assume that  $h$  is a linear transformation of  $V$  and that  $\langle \vec{\beta}_1, \dots, \vec{\beta}_n \rangle$  is a basis of  $V$ . Prove each statement.

(a) If  $h(\vec{\beta}_i) = \vec{0}$  for each basis vector then  $h$  is the zero map.



(b) If  $h(\vec{\beta}_i) = \vec{\beta}_i$  for each basis vector then  $h$  is the identity map.

(c) If there is a scalar  $r$  such that  $h(\vec{\beta}_i) = r \cdot \vec{\beta}_i$  for each basis vector then  $h(\vec{v}) = r \cdot \vec{v}$  for all vectors in  $V$ .

- ✓ 1.26 Consider the vector space  $\mathbb{R}^+$  where vector addition and scalar multiplication are not the ones inherited from  $\mathbb{R}$  but rather are these:  $a + b$  is the product of  $a$  and  $b$ , and  $r \cdot a$  is the  $r$ -th power of  $a$ . (This was shown to be a vector space in an earlier exercise.) Verify that the natural logarithm map  $\ln: \mathbb{R}^+ \rightarrow \mathbb{R}$  is a homomorphism between these two spaces. Is it an isomorphism?

- ✓ 1.27 Consider this transformation of  $\mathbb{R}^2$ .

$$\begin{pmatrix} x \\ y \end{pmatrix} \mapsto \begin{pmatrix} x/2 \\ y/3 \end{pmatrix}$$

Find the image under this map of this ellipse.

$$\left\{ \begin{pmatrix} x \\ y \end{pmatrix} \mid (x^2/4) + (y^2/9) = 1 \right\}$$

- ✓ 1.28 Imagine a rope wound around the earth's equator so that it fits snugly (suppose that the earth is a sphere). How much extra rope must we add to raise the circle to a constant six feet off the ground?

- ✓ 1.29 Verify that this map  $h: \mathbb{R}^3 \rightarrow \mathbb{R}$

$$\begin{pmatrix} x \\ y \\ z \end{pmatrix} \mapsto \begin{pmatrix} x \\ y \\ z \end{pmatrix} \cdot \begin{pmatrix} 3 \\ -1 \\ -1 \end{pmatrix} = 3x - y - z$$

is linear. Generalize.

- 1.30 Show that every homomorphism from  $\mathbb{R}^1$  to  $\mathbb{R}^1$  acts via multiplication by a scalar. Conclude that every nontrivial linear transformation of  $\mathbb{R}^1$  is an isomorphism. Is that true for transformations of  $\mathbb{R}^2$ ?  $\mathbb{R}^n$ ?

- 1.31 (a) Show that for any scalars  $a_{1,1}, \dots, a_{m,n}$  this map  $h: \mathbb{R}^n \rightarrow \mathbb{R}^m$  is a homomorphism.

$$\begin{pmatrix} x_1 \\ \vdots \\ x_n \end{pmatrix} \mapsto \begin{pmatrix} a_{1,1}x_1 + \dots + a_{1,n}x_n \\ \vdots \\ a_{m,1}x_1 + \dots + a_{m,n}x_n \end{pmatrix}$$

(b) Show that for each  $i$ , the  $i$ -th derivative operator  $d^i/dx^i$  is a linear transformation of  $\mathcal{P}_n$ . Conclude that for any scalars  $c_k, \dots, c_0$  this map is a linear transformation of that space.

$$f \mapsto \frac{d^k}{dx^k} f + c_{k-1} \frac{d^{k-1}}{dx^{k-1}} f + \dots + c_1 \frac{d}{dx} f + c_0 f$$

- 1.32 Lemma 1.16 shows that a sum of linear functions is linear and that a scalar multiple of a linear function is linear. Show also that a composition of linear functions is linear.

- ✓ 1.33 Where  $f: V \rightarrow W$  is linear, suppose that  $f(\vec{v}_1) = \vec{w}_1, \dots, f(\vec{v}_n) = \vec{w}_n$  for some vectors  $\vec{w}_1, \dots, \vec{w}_n$  from  $W$ .

(a) If the set of  $\vec{w}$ 's is independent, must the set of  $\vec{v}$ 's also be independent?

(b) If the set of  $\vec{v}$ 's is independent, must the set of  $\vec{w}$ 's also be independent?

(c) If the set of  $\vec{w}$ 's spans  $W$ , must the set of  $\vec{v}$ 's span  $V$ ?

(d) If the set of  $\vec{v}$ 's spans  $V$ , must the set of  $\vec{w}$ 's span  $W$ ?

- 1.34 Generalize Example 1.15 by proving that the matrix transpose map is linear. What is the domain and codomain?

- 1.35 (a) Where  $\vec{u}, \vec{v} \in \mathbb{R}^n$ , by definition the line segment connecting them is the set  $\ell = \{t \cdot \vec{u} + (1-t) \cdot \vec{v} \mid t \in [0,1]\}$ . Show that the image, under a homomorphism  $h$ , of the segment between  $\vec{u}$  and  $\vec{v}$  is the segment between  $h(\vec{u})$  and  $h(\vec{v})$ .
- (b) A subset of  $\mathbb{R}^n$  is *convex* if, for any two points in that set, the line segment joining them lies entirely in that set. (The inside of a sphere is convex while the skin of a sphere is not.) Prove that linear maps from  $\mathbb{R}^n$  to  $\mathbb{R}^m$  preserve the property of set convexity.
- ✓ 1.36 Let  $h: \mathbb{R}^n \rightarrow \mathbb{R}^m$  be a homomorphism.
- (a) Show that the image under  $h$  of a line in  $\mathbb{R}^n$  is a (possibly degenerate) line in  $\mathbb{R}^m$ .
- (b) What happens to a  $k$ -dimensional linear surface?
- 1.37 Prove that the restriction of a homomorphism to a subspace of its domain is another homomorphism.
- 1.38 Assume that  $h: V \rightarrow W$  is linear.
- (a) Show that the *rangespace* of this map  $\{h(\vec{v}) \mid \vec{v} \in V\}$  is a subspace of the codomain  $W$ .
- (b) Show that the *nullspace* of this map  $\{\vec{v} \in V \mid h(\vec{v}) = \vec{0}_W\}$  is a subspace of the domain  $V$ .
- (c) Show that if  $U$  is a subspace of the domain  $V$  then its image  $\{h(\vec{u}) \mid \vec{u} \in U\}$  is a subspace of the codomain  $W$ . This generalizes the first item.
- (d) Generalize the second item.
- 1.39 Consider the set of isomorphisms from a vector space to itself. Is this a subspace of the space  $\mathcal{L}(V, V)$  of homomorphisms from the space to itself?
- 1.40 Does Theorem 1.9 need that  $\langle \vec{\beta}_1, \dots, \vec{\beta}_n \rangle$  is a basis? That is, can we still get a well-defined and unique homomorphism if we drop either the condition that the set of  $\vec{\beta}$ 's be linearly independent, or the condition that it span the domain?
- 1.41 Let  $V$  be a vector space and assume that the maps  $f_1, f_2: V \rightarrow \mathbb{R}^1$  are linear.
- (a) Define a map  $F: V \rightarrow \mathbb{R}^2$  whose component functions are the given linear ones.
- $$\vec{v} \mapsto \begin{pmatrix} f_1(\vec{v}) \\ f_2(\vec{v}) \end{pmatrix}$$
- Show that  $F$  is linear.
- (b) Does the converse hold — is any linear map from  $V$  to  $\mathbb{R}^2$  made up of two linear component maps to  $\mathbb{R}^1$ ?
- (c) Generalize.

## II.2 Rangespace and Nullspace

Isomorphisms and homomorphisms both preserve structure. The difference is that homomorphisms are subject to fewer restrictions because they needn't be onto and needn't be one-to-one. We will examine what can happen with homomorphisms that cannot happen to isomorphisms.

We first consider the effect of not requiring that a homomorphism be onto its codomain. Of course, each homomorphism is onto some set, namely its range.

For example, the injection map  $\iota: \mathbb{R}^2 \rightarrow \mathbb{R}^3$

$$\begin{pmatrix} x \\ y \end{pmatrix} \mapsto \begin{pmatrix} x \\ y \\ 0 \end{pmatrix}$$

is a homomorphism that is not onto. But,  $\iota$  is onto the  $xy$ -plane subset of  $\mathbb{R}^3$ .

**2.1 Lemma** Under a homomorphism, the image of any subspace of the domain is a subspace of the codomain. In particular, the image of the entire space, the range of the homomorphism, is a subspace of the codomain.

**PROOF** Let  $h: V \rightarrow W$  be linear and let  $S$  be a subspace of the domain  $V$ . The image  $h(S)$  is a subset of the codomain  $W$ , which is nonempty because  $S$  is nonempty. Thus, to show that  $h(S)$  is a subspace of  $W$  we need only show that it is closed under linear combinations of two vectors. If  $h(\vec{s}_1)$  and  $h(\vec{s}_2)$  are members of  $h(S)$  then  $c_1 \cdot h(\vec{s}_1) + c_2 \cdot h(\vec{s}_2) = h(c_1 \cdot \vec{s}_1) + h(c_2 \cdot \vec{s}_2) = h(c_1 \cdot \vec{s}_1 + c_2 \cdot \vec{s}_2)$  is also a member of  $h(S)$  because it is the image of  $c_1 \cdot \vec{s}_1 + c_2 \cdot \vec{s}_2$  from  $S$ . QED

**2.2 Definition** The *rangespace* of a homomorphism  $h: V \rightarrow W$  is

$$\mathcal{R}(h) = \{h(\vec{v}) \mid \vec{v} \in V\}$$

sometimes denoted  $h(V)$ . The dimension of the rangespace is the map's *rank*.

We shall soon see the connection between the rank of a map and the rank of a matrix.

**2.3 Example** For the derivative map  $d/dx: \mathcal{P}_3 \rightarrow \mathcal{P}_3$  given by  $a_0 + a_1x + a_2x^2 + a_3x^3 \mapsto a_1 + 2a_2x + 3a_3x^2$  the rangespace  $\mathcal{R}(d/dx)$  is the set of quadratic polynomials  $\{r + sx + tx^2 \mid r, s, t \in \mathbb{R}\}$ . Thus, this map's rank is 3.

**2.4 Example** With this homomorphism  $h: M_{2 \times 2} \rightarrow \mathcal{P}_3$

$$\begin{pmatrix} a & b \\ c & d \end{pmatrix} \mapsto (a + b + 2d) + cx^2 + cx^3$$

an image vector in the range can have any constant term, must have an  $x$  coefficient of zero, and must have the same coefficient of  $x^2$  as of  $x^3$ . That is, the rangespace is  $\mathcal{R}(h) = \{r + sx^2 + sx^3 \mid r, s \in \mathbb{R}\}$  and so the rank is 2.

The prior result shows that, in passing from the definition of isomorphism to the more general definition of homomorphism, omitting the 'onto' requirement doesn't make an essential difference. Any homomorphism is onto its rangespace.

However, omitting the 'one-to-one' condition does make a difference. A homomorphism may have many elements of the domain that map to one element of the codomain. Below is a "bean" sketch of a many-to-one map between sets.\* It shows three elements of the codomain that are each the image of many members of the domain.

\* More information on many-to-one maps is in the appendix.

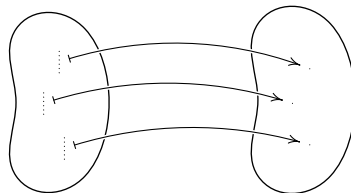

Recall that for any function  $h: V \rightarrow W$ , the set of elements of  $V$  that map to  $\vec{w} \in W$  is the *inverse image*  $h^{-1}(\vec{w}) = \{\vec{v} \in V \mid h(\vec{v}) = \vec{w}\}$ . Above, the left bean shows three inverse image sets.

**2.5 Example** Consider the projection  $\pi: \mathbb{R}^3 \rightarrow \mathbb{R}^2$

$$\begin{pmatrix} x \\ y \\ z \end{pmatrix} \mapsto \begin{pmatrix} x \\ y \end{pmatrix}$$

which is a homomorphism that is many-to-one. An inverse image set is a vertical line of vectors in the domain.

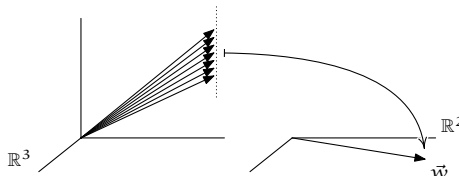

One example is this.

$$\pi^{-1}\left(\begin{pmatrix} 1 \\ 3 \end{pmatrix}\right) = \left\{ \begin{pmatrix} 1 \\ 3 \\ z \end{pmatrix} \mid z \in \mathbb{R} \right\}$$

**2.6 Example** This homomorphism  $h: \mathbb{R}^2 \rightarrow \mathbb{R}^1$

$$\begin{pmatrix} x \\ y \end{pmatrix} \mapsto x + y$$

is also many-to-one. For a fixed  $w \in \mathbb{R}^1$ , the inverse image  $h^{-1}(w)$

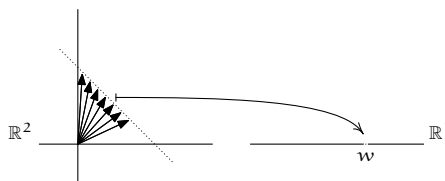

is the set of plane vectors whose components add to  $w$ .

In generalizing from isomorphisms to homomorphisms by dropping the one-to-one condition, we lose the property that we've stated intuitively as that the domain is "the same" as the range. We lose that the domain corresponds perfectly to the range. What we retain, as the examples below illustrate, is that a homomorphism describes how the domain is "like" or "analogous to" the range.

**2.7 Example** We think of  $\mathbb{R}^3$  as like  $\mathbb{R}^2$  except that vectors have an extra component. That is, we think of the vector with components  $x$ ,  $y$ , and  $z$  as somehow like the vector with components  $x$  and  $y$ . In defining the projection map  $\pi$ , we make precise which members of the domain we are thinking of as related to which members of the codomain.

To understanding how the preservation conditions in the definition of homomorphism show that the domain elements are like the codomain elements, we start by picturing  $\mathbb{R}^2$  as the  $xy$ -plane inside of  $\mathbb{R}^3$ . (Of course,  $\mathbb{R}^2$  is not the  $xy$  plane inside of  $\mathbb{R}^3$  since the  $xy$  plane is a set of three-tall vectors with a third component of zero, but there is a natural correspondence.) Then the preservation of addition property says that vectors in  $\mathbb{R}^3$  act like their shadows in the plane.

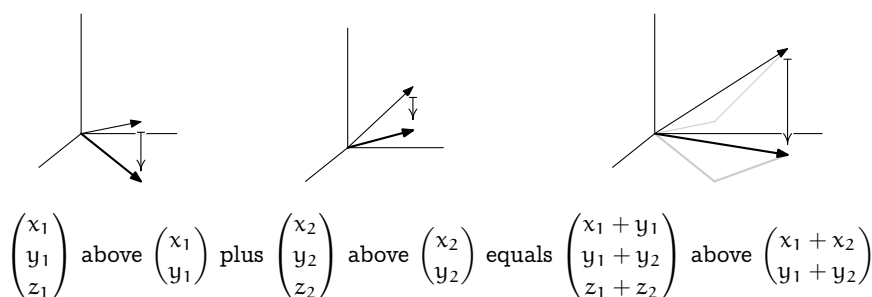

Thinking of  $\pi(\vec{v})$  as the “shadow” of  $\vec{v}$  in the plane gives this restatement: the sum of the shadows  $\pi(\vec{v}_1) + \pi(\vec{v}_2)$  equals the shadow of the sum  $\pi(\vec{v}_1 + \vec{v}_2)$ . Preservation of scalar multiplication is similar.

Redrawing by showing the codomain  $\mathbb{R}^2$  on the right gives a picture that is uglier but is more faithful to the “bean” sketch.

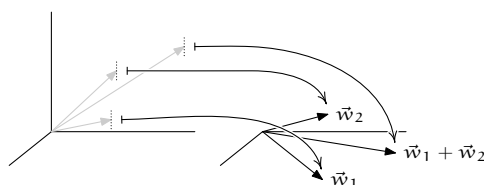

Again, the domain vectors that map to  $\vec{w}_1$  lie in a vertical line; the picture shows one in gray. Call any member of this inverse image  $\pi^{-1}(\vec{w}_1)$  a “ $\vec{w}_1$  vector.” Similarly, there is a vertical line of “ $\vec{w}_2$  vectors” and a vertical line of “ $\vec{w}_1 + \vec{w}_2$  vectors.” Now, saying that  $\pi$  is a homomorphism is recognizing that if  $\pi(\vec{v}_1) = \vec{w}_1$  and  $\pi(\vec{v}_2) = \vec{w}_2$  then  $\pi(\vec{v}_1 + \vec{v}_2) = \pi(\vec{v}_1) + \pi(\vec{v}_2) = \vec{w}_1 + \vec{w}_2$ . That is, the classes add: any  $\vec{w}_1$  vector plus any  $\vec{w}_2$  vector equals a  $\vec{w}_1 + \vec{w}_2$  vector. Scalar multiplication is similar.

So although  $\mathbb{R}^3$  and  $\mathbb{R}^2$  are not isomorphic  $\pi$  describes a way in which they are alike: vectors in  $\mathbb{R}^3$  add as do the associated vectors in  $\mathbb{R}^2$  — vectors add as their shadows add.

**2.8 Example** A homomorphism can express an analogy between spaces that is

more subtle than the prior one. For the map from Example 2.6

$$\begin{pmatrix} x \\ y \end{pmatrix} \xrightarrow{h} x + y$$

fix two numbers  $w_1, w_2$  in the range  $\mathbb{R}$ . A  $\vec{v}_1$  that maps to  $w_1$  has components that add to  $w_1$ , so the inverse image  $h^{-1}(w_1)$  is the set of vectors with endpoint on the diagonal line  $x + y = w_1$ . Think of these as “ $w_1$  vectors.” Similarly we have “ $w_2$  vectors” and “ $w_1 + w_2$  vectors.” The addition preservation property says this.

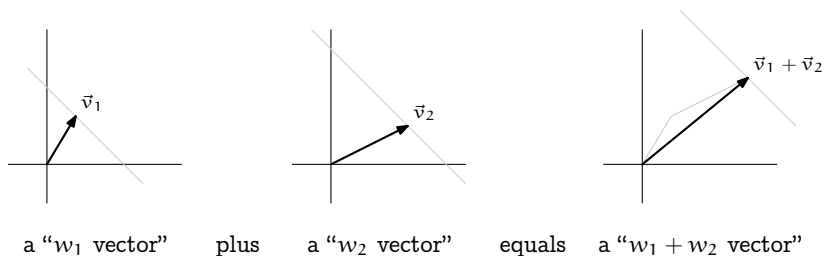

Restated, if we add a  $w_1$  vector to a  $w_2$  vector then  $h$  maps the result to a  $w_1 + w_2$  vector. Briefly, the sum of the images is the image of the sum. Even more briefly,  $h(\vec{v}_1) + h(\vec{v}_2) = h(\vec{v}_1 + \vec{v}_2)$ .

**2.9 Example** The inverse images can be structures other than lines. For the linear map  $h: \mathbb{R}^3 \rightarrow \mathbb{R}^2$

$$\begin{pmatrix} x \\ y \\ z \end{pmatrix} \mapsto \begin{pmatrix} x \\ x \end{pmatrix}$$

the inverse image sets are planes  $x = 0$ ,  $x = 1$ , etc., perpendicular to the  $x$ -axis.

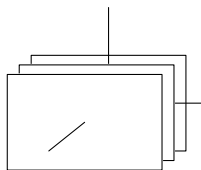

We won’t describe how every homomorphism that we will use is an analogy because the formal sense that we make of “alike in that . . .” is ‘a homomorphism exists such that . . .’. Nonetheless, the idea that a homomorphism between two spaces expresses how the domain’s vectors fall into classes that act like the range’s vectors is a good way to view homomorphisms.

Another reason that we won’t treat all of the homomorphisms that we see as above is that many vector spaces are hard to draw, e.g., a space of polynomials. But there is nothing wrong with leveraging those spaces that we can draw. We derive two insights from the three examples 2.7, 2.8, and 2.9.

The first insight is that in all three examples the inverse image of the range’s zero vector is a line or plane through the origin, a subspace of the domain.

**2.10 Lemma** For any homomorphism, the inverse image of a subspace of the range is a subspace of the domain. In particular, the inverse image of the trivial subspace of the range is a subspace of the domain.

**PROOF** Let  $h: V \rightarrow W$  be a homomorphism and let  $S$  be a subspace of the rangespace of  $h$ . Consider the inverse image  $h^{-1}(S) = \{\vec{v} \in V \mid h(\vec{v}) \in S\}$ . It is nonempty because it contains  $\vec{0}_V$ , since  $h(\vec{0}_V) = \vec{0}_W$  and  $\vec{0}_W$  is an element of  $S$ , as  $S$  is a subspace. To finish we show that it is closed under linear combinations. Let  $\vec{v}_1$  and  $\vec{v}_2$  be two elements of  $h^{-1}(S)$ . Then  $h(\vec{v}_1)$  and  $h(\vec{v}_2)$  are elements of  $S$ . That implies that  $c_1\vec{v}_1 + c_2\vec{v}_2$  is an element of the inverse image  $h^{-1}(S)$  because  $h(c_1\vec{v}_1 + c_2\vec{v}_2) = c_1h(\vec{v}_1) + c_2h(\vec{v}_2)$  is a member of  $S$ . QED

**2.11 Definition** The *nullspace* or *kernel* of a linear map  $h: V \rightarrow W$  is the inverse image of  $0_W$ .

$$\mathcal{N}(h) = h^{-1}(\vec{0}_W) = \{\vec{v} \in V \mid h(\vec{v}) = \vec{0}_W\}$$

The dimension of the nullspace is the map's *nullity*.

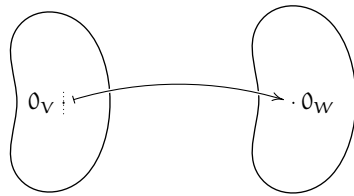

**2.12 Example** The map from Example 2.3 has this nullspace  $\mathcal{N}(d/dx) = \{a_0 + 0x + 0x^2 + 0x^3 \mid a_0 \in \mathbb{R}\}$  so its nullity is 1.

**2.13 Example** The map from Example 2.4 has this nullspace and nullity 2.

$$\mathcal{N}(h) = \left\{ \begin{pmatrix} a & b \\ 0 & -(a+b)/2 \end{pmatrix} \mid a, b \in \mathbb{R} \right\}$$

Now for the second insight from the above pictures. In Example 2.7 each of the vertical lines squashes down to a single point — in passing from the domain to the range,  $\pi$  takes all of these one-dimensional vertical lines and maps them to a point, leaving the range one dimension smaller than the domain. Similarly, in Example 2.8 the two-dimensional domain compresses to a one-dimensional range by breaking the domain into the diagonal lines and maps each of those to a single member of the range. Finally, in Example 2.9 the domain breaks into planes which get squashed to a point and so the map starts with a three-dimensional domain but ends with a one-dimensional range. (In this third example the codomain is two-dimensional but the range of the map is only one-dimensional and it is the dimension of the range that matters.)

**2.14 Theorem** A linear map's rank plus its nullity equals the dimension of its domain.

**PROOF** Let  $h: V \rightarrow W$  be linear and let  $B_N = \langle \vec{\beta}_1, \dots, \vec{\beta}_k \rangle$  be a basis for the nullspace. Expand that to a basis  $B_V = \langle \vec{\beta}_1, \dots, \vec{\beta}_k, \vec{\beta}_{k+1}, \dots, \vec{\beta}_n \rangle$  for the entire domain, using Corollary Two.III.2.12. We shall show that  $B_R = \langle h(\vec{\beta}_{k+1}), \dots, h(\vec{\beta}_n) \rangle$  is a basis for the rangespace. With that, counting the size of these bases gives the result.

To see that  $B_R$  is linearly independent, consider  $\vec{0}_W = c_{k+1}h(\vec{\beta}_{k+1}) + \dots + c_n h(\vec{\beta}_n)$ . The function is linear so we have  $\vec{0}_W = h(c_{k+1}\vec{\beta}_{k+1} + \dots + c_n\vec{\beta}_n)$  and therefore  $c_{k+1}\vec{\beta}_{k+1} + \dots + c_n\vec{\beta}_n$  is in the nullspace of  $h$ . As  $B_N$  is a basis for the nullspace there are scalars  $c_1, \dots, c_k$  satisfying this relationship.

$$c_1\vec{\beta}_1 + \dots + c_k\vec{\beta}_k = c_{k+1}\vec{\beta}_{k+1} + \dots + c_n\vec{\beta}_n$$

But this is an equation among the members of  $B_V$ , which is a basis for  $V$ , so each  $c_i$  equals 0. Therefore  $B_R$  is linearly independent.

To show that  $B_R$  spans the rangespace, consider  $h(\vec{v}) \in \mathcal{R}(h)$  and write  $\vec{v}$  as a linear combination  $\vec{v} = c_1\vec{\beta}_1 + \dots + c_n\vec{\beta}_n$  of members of  $B_V$ . This gives  $h(\vec{v}) = h(c_1\vec{\beta}_1 + \dots + c_n\vec{\beta}_n) = c_1h(\vec{\beta}_1) + \dots + c_kh(\vec{\beta}_k) + c_{k+1}h(\vec{\beta}_{k+1}) + \dots + c_nh(\vec{\beta}_n)$  and since  $\vec{\beta}_1, \dots, \vec{\beta}_k$  are in the nullspace, we have that  $h(\vec{v}) = \vec{0} + \dots + \vec{0} + c_{k+1}h(\vec{\beta}_{k+1}) + \dots + c_nh(\vec{\beta}_n)$ . Thus,  $h(\vec{v})$  is a linear combination of members of  $B_R$ , and so  $B_R$  spans the rangespace. QED

**2.15 Example** Where  $h: \mathbb{R}^3 \rightarrow \mathbb{R}^4$  is

$$\begin{pmatrix} x \\ y \\ z \end{pmatrix} \xrightarrow{h} \begin{pmatrix} x \\ 0 \\ y \\ 0 \end{pmatrix}$$

the rangespace and nullspace are

$$\mathcal{R}(h) = \left\{ \begin{pmatrix} a \\ 0 \\ b \\ 0 \end{pmatrix} \mid a, b \in \mathbb{R} \right\} \quad \text{and} \quad \mathcal{N}(h) = \left\{ \begin{pmatrix} 0 \\ 0 \\ z \end{pmatrix} \mid z \in \mathbb{R} \right\}$$

and so the rank of  $h$  is 2 while the nullity is 1.

**2.16 Example** If  $t: \mathbb{R} \rightarrow \mathbb{R}$  is the linear transformation  $x \mapsto -4x$ , then the range is  $\mathcal{R}(t) = \mathbb{R}^1$ . The rank is 1 and the nullity is 0.

**2.17 Corollary** The rank of a linear map is less than or equal to the dimension of the domain. Equality holds if and only if the nullity of the map is 0.

We know that an isomorphism exists between two spaces if and only if the dimension of the range equals the dimension of the domain. We have now seen



that for a homomorphism to exist a necessary condition is that the dimension of the range must be less than or equal to the dimension of the domain. For instance, there is no homomorphism from  $\mathbb{R}^2$  onto  $\mathbb{R}^3$ . There are many homomorphisms from  $\mathbb{R}^2$  into  $\mathbb{R}^3$ , but none onto.

The rangespace of a linear map can be of dimension strictly less than the dimension of the domain and so linearly independent sets in the domain may map to linearly dependent sets in the range. (Example 2.3's derivative transformation on  $\mathcal{P}_3$  has a domain of dimension 4 but a range of dimension 3 and the derivative sends  $\{1, x, x^2, x^3\}$  to  $\{0, 1, 2x, 3x^2\}$ ). That is, under a homomorphism independence may be lost. In contrast, dependence stays.

**2.18 Lemma** Under a linear map, the image of a linearly dependent set is linearly dependent.

**PROOF** Suppose that  $c_1\vec{v}_1 + \cdots + c_n\vec{v}_n = \vec{0}_V$  with some  $c_i$  nonzero. Apply  $h$  to both sides:  $h(c_1\vec{v}_1 + \cdots + c_n\vec{v}_n) = c_1h(\vec{v}_1) + \cdots + c_nh(\vec{v}_n)$  and  $h(\vec{0}_V) = \vec{0}_W$ . Thus we have  $c_1h(\vec{v}_1) + \cdots + c_nh(\vec{v}_n) = \vec{0}_W$  with some  $c_i$  nonzero. QED

When is independence not lost? The obvious sufficient condition is when the homomorphism is an isomorphism. This condition is also necessary; see Exercise 34. We will finish this subsection comparing homomorphisms with isomorphisms by observing that a one-to-one homomorphism is an isomorphism from its domain onto its range.

**2.19 Example** This one-to-one homomorphism  $\iota: \mathbb{R}^2 \rightarrow \mathbb{R}^3$

$$\begin{pmatrix} x \\ y \end{pmatrix} \xrightarrow{\iota} \begin{pmatrix} x \\ y \\ 0 \end{pmatrix}$$

gives a correspondence between  $\mathbb{R}^2$  and the  $xy$ -plane subset of  $\mathbb{R}^3$ .

**2.20 Theorem** In an  $n$ -dimensional vector space  $V$ , these are equivalent statements about a linear map  $h: V \rightarrow W$ .

- (1)  $h$  is one-to-one
- (2)  $h$  has an inverse from its range to its domain that is linear
- (3)  $\mathcal{N}(h) = \{\vec{0}\}$ , that is,  $\text{nullity}(h) = 0$
- (4)  $\text{rank}(h) = n$
- (5) if  $\langle \vec{\beta}_1, \dots, \vec{\beta}_n \rangle$  is a basis for  $V$  then  $\langle h(\vec{\beta}_1), \dots, h(\vec{\beta}_n) \rangle$  is a basis for  $\mathcal{R}(h)$

**PROOF** We will first show that (1)  $\iff$  (2). We will then show that (1)  $\implies$  (3)  $\implies$  (4)  $\implies$  (5)  $\implies$  (2).

For (1)  $\implies$  (2), suppose that the linear map  $h$  is one-to-one and so has an inverse  $h^{-1}: \mathcal{R}(h) \rightarrow V$ . The domain of that inverse is the range of  $h$  and thus a linear combination of two members of it has the form  $c_1h(\vec{v}_1) + c_2h(\vec{v}_2)$ . On

that combination, the inverse  $h^{-1}$  gives this.

$$\begin{aligned} h^{-1}(c_1 h(\vec{v}_1) + c_2 h(\vec{v}_2)) &= h^{-1}(h(c_1 \vec{v}_1 + c_2 \vec{v}_2)) \\ &= h^{-1} \circ h(c_1 \vec{v}_1 + c_2 \vec{v}_2) \\ &= c_1 \vec{v}_1 + c_2 \vec{v}_2 \\ &= c_1 \cdot h^{-1}(h(\vec{v}_1)) + c_2 \cdot h^{-1}(h(\vec{v}_2)) \end{aligned}$$

Thus if a linear map has an inverse, then the inverse must be linear. But this also gives the (2)  $\implies$  (1) implication, because the inverse itself must be one-to-one.

Of the remaining implications, (1)  $\implies$  (3) holds because any homomorphism maps  $\vec{0}_V$  to  $\vec{0}_W$ , but a one-to-one map sends at most one member of  $V$  to  $\vec{0}_W$ .

Next, (3)  $\implies$  (4) is true since rank plus nullity equals the dimension of the domain.

For (4)  $\implies$  (5), to show that  $\langle h(\vec{\beta}_1), \dots, h(\vec{\beta}_n) \rangle$  is a basis for the rangespace we need only show that it is a spanning set, because by assumption the range has dimension  $n$ . Consider  $h(\vec{v}) \in \mathcal{R}(h)$ . Expressing  $\vec{v}$  as a linear combination of basis elements produces  $h(\vec{v}) = h(c_1 \vec{\beta}_1 + c_2 \vec{\beta}_2 + \dots + c_n \vec{\beta}_n)$ , which gives that  $h(\vec{v}) = c_1 h(\vec{\beta}_1) + \dots + c_n h(\vec{\beta}_n)$ , as desired.

Finally, for the (5)  $\implies$  (2) implication, assume that  $\langle \vec{\beta}_1, \dots, \vec{\beta}_n \rangle$  is a basis for  $V$  so that  $\langle h(\vec{\beta}_1), \dots, h(\vec{\beta}_n) \rangle$  is a basis for  $\mathcal{R}(h)$ . Then every  $\vec{w} \in \mathcal{R}(h)$  has the unique representation  $\vec{w} = c_1 h(\vec{\beta}_1) + \dots + c_n h(\vec{\beta}_n)$ . Define a map from  $\mathcal{R}(h)$  to  $V$  by

$$\vec{w} \mapsto c_1 \vec{\beta}_1 + c_2 \vec{\beta}_2 + \dots + c_n \vec{\beta}_n$$

(uniqueness of the representation makes this well-defined). Checking that it is linear and that it is the inverse of  $h$  are easy. QED

We have now seen that a linear map expresses how the structure of the domain is like that of the range. We can think of such a map as organizing the domain space into inverse images of points in the range. In the special case that the map is one-to-one, each inverse image is a single point and the map is an isomorphism between the domain and the range.

### Exercises

✓ 2.21 Let  $h: \mathcal{P}_3 \rightarrow \mathcal{P}_4$  be given by  $p(x) \mapsto x \cdot p(x)$ . Which of these are in the nullspace?

Which are in the rangespace?

(a)  $x^3$    (b)  $0$    (c)  $7$    (d)  $12x - 0.5x^3$    (e)  $1 + 3x^2 - x^3$

✓ 2.22 Find the nullspace, nullity, rangespace, and rank of each map.

(a)  $h: \mathbb{R}^2 \rightarrow \mathcal{P}_3$  given by

$$\begin{pmatrix} a \\ b \end{pmatrix} \mapsto a + ax + ax^2$$

(b)  $h: \mathcal{M}_{2 \times 2} \rightarrow \mathbb{R}$  given by

$$\begin{pmatrix} a & b \\ c & d \end{pmatrix} \mapsto a + d$$

(c)  $h: \mathcal{M}_{2 \times 2} \rightarrow \mathcal{P}_2$  given by

$$\begin{pmatrix} a & b \\ c & d \end{pmatrix} \mapsto a + b + c + dx^2$$

- (d) the zero map  $Z: \mathbb{R}^3 \rightarrow \mathbb{R}^4$
- ✓ 2.23 Find the nullity of each map.  
 (a)  $h: \mathbb{R}^5 \rightarrow \mathbb{R}^8$  of rank five    (b)  $h: \mathcal{P}_3 \rightarrow \mathcal{P}_3$  of rank one  
 (c)  $h: \mathbb{R}^6 \rightarrow \mathbb{R}^3$ , an onto map    (d)  $h: \mathcal{M}_{3 \times 3} \rightarrow \mathcal{M}_{3 \times 3}$ , onto
- ✓ 2.24 What is the nullspace of the differentiation transformation  $d/dx: \mathcal{P}_n \rightarrow \mathcal{P}_n$ ? What is the nullspace of the second derivative, as a transformation of  $\mathcal{P}_n$ ? The  $k$ -th derivative?
- 2.25 Example 2.7 restates the first condition in the definition of homomorphism as ‘the shadow of a sum is the sum of the shadows’. Restate the second condition in the same style.
- 2.26 For the homomorphism  $h: \mathcal{P}_3 \rightarrow \mathcal{P}_3$  given by  $h(a_0 + a_1x + a_2x^2 + a_3x^3) = a_0 + (a_0 + a_1)x + (a_2 + a_3)x^3$  find these.  
 (a)  $\mathcal{N}(h)$     (b)  $h^{-1}(2 - x^3)$     (c)  $h^{-1}(1 + x^2)$
- ✓ 2.27 For the map  $f: \mathbb{R}^2 \rightarrow \mathbb{R}$  given by
- $$f\left(\begin{pmatrix} x \\ y \end{pmatrix}\right) = 2x + y$$
- sketch these inverse image sets:  $f^{-1}(-3)$ ,  $f^{-1}(0)$ , and  $f^{-1}(1)$ .
- ✓ 2.28 Each of these transformations of  $\mathcal{P}_3$  is one-to-one. Find the inverse of each.
- (a)  $a_0 + a_1x + a_2x^2 + a_3x^3 \mapsto a_0 + a_1x + 2a_2x^2 + 3a_3x^3$   
 (b)  $a_0 + a_1x + a_2x^2 + a_3x^3 \mapsto a_0 + a_2x + a_1x^2 + a_3x^3$   
 (c)  $a_0 + a_1x + a_2x^2 + a_3x^3 \mapsto a_1 + a_2x + a_3x^2 + a_0x^3$   
 (d)  $a_0 + a_1x + a_2x^2 + a_3x^3 \mapsto a_0 + (a_0 + a_1)x + (a_0 + a_1 + a_2)x^2 + (a_0 + a_1 + a_2 + a_3)x^3$
- 2.29 Describe the nullspace and rangespace of a transformation given by  $\vec{v} \mapsto 2\vec{v}$ .
- 2.30 List all pairs  $(\text{rank}(h), \text{nullity}(h))$  that are possible for linear maps from  $\mathbb{R}^5$  to  $\mathbb{R}^3$ .
- 2.31 Does the differentiation map  $d/dx: \mathcal{P}_n \rightarrow \mathcal{P}_n$  have an inverse?
- ✓ 2.32 Find the nullity of the map  $h: \mathcal{P}_n \rightarrow \mathbb{R}$  given by
- $$a_0 + a_1x + \cdots + a_nx^n \mapsto \int_{x=0}^{x=1} a_0 + a_1x + \cdots + a_nx^n dx.$$
- 2.33 (a) Prove that a homomorphism is onto if and only if its rank equals the dimension of its codomain.  
 (b) Conclude that a homomorphism between vector spaces with the same dimension is one-to-one if and only if it is onto.
- 2.34 Show that a linear map is one-to-one if and only if it preserves linear independence.
- 2.35 Corollary 2.17 says that for there to be an onto homomorphism from a vector space  $V$  to a vector space  $W$ , it is necessary that the dimension of  $W$  be less than or equal to the dimension of  $V$ . Prove that this condition is also sufficient; use Theorem 1.9 to show that if the dimension of  $W$  is less than or equal to the dimension of  $V$ , then there is a homomorphism from  $V$  to  $W$  that is onto.
- ✓ 2.36 Recall that the nullspace is a subset of the domain and the rangespace is a subset of the codomain. Are they necessarily distinct? Is there a homomorphism that has a nontrivial intersection of its nullspace and its rangespace?
- 2.37 Prove that the image of a span equals the span of the images. That is, where  $h: V \rightarrow W$  is linear, prove that if  $S$  is a subset of  $V$  then  $h([S])$  equals  $[h(S)]$ . This generalizes Lemma 2.1 since it shows that if  $U$  is any subspace of  $V$  then its image  $\{h(\vec{u}) \mid \vec{u} \in U\}$  is a subspace of  $W$ , because the span of the set  $U$  is  $U$ .

- ✓ 2.38 (a) Prove that for any linear map  $h: V \rightarrow W$  and any  $\vec{w} \in W$ , the set  $h^{-1}(\vec{w})$  has the form

$$\{\vec{v} + \vec{n} \mid \vec{n} \in \mathcal{N}(h)\}$$

for  $\vec{v} \in V$  with  $h(\vec{v}) = \vec{w}$  (if  $h$  is not onto then this set may be empty). Such a set is a *coset* of  $\mathcal{N}(h)$  and we denote it as  $\vec{v} + \mathcal{N}(h)$ .

- (b) Consider the map  $t: \mathbb{R}^2 \rightarrow \mathbb{R}^2$  given by

$$\begin{pmatrix} x \\ y \end{pmatrix} \mapsto \begin{pmatrix} ax + by \\ cx + dy \end{pmatrix}$$

for some scalars  $a, b, c,$  and  $d$ . Prove that  $t$  is linear.

- (c) Conclude from the prior two items that for any linear system of the form

$$\begin{aligned} ax + by &= e \\ cx + dy &= f \end{aligned}$$

we can write the solution set (the vectors are members of  $\mathbb{R}^2$ )

$$\{\vec{p} + \vec{h} \mid \vec{h} \text{ satisfies the associated homogeneous system}\}$$

where  $\vec{p}$  is a particular solution of that linear system (if there is no particular solution then the above set is empty).

- (d) Show that this map  $h: \mathbb{R}^n \rightarrow \mathbb{R}^m$  is linear

$$\begin{pmatrix} x_1 \\ \vdots \\ x_n \end{pmatrix} \mapsto \begin{pmatrix} a_{1,1}x_1 + \cdots + a_{1,n}x_n \\ \vdots \\ a_{m,1}x_1 + \cdots + a_{m,n}x_n \end{pmatrix}$$

for any scalars  $a_{1,1}, \dots, a_{m,n}$ . Extend the conclusion made in the prior item.

- (e) Show that the  $k$ -th derivative map is a linear transformation of  $\mathcal{P}_n$  for each  $k$ . Prove that this map is a linear transformation of that space

$$f \mapsto \frac{d^k}{dx^k} f + c_{k-1} \frac{d^{k-1}}{dx^{k-1}} f + \cdots + c_1 \frac{d}{dx} f + c_0 f$$

for any scalars  $c_k, \dots, c_0$ . Draw a conclusion as above.

- 2.39 Prove that for any transformation  $t: V \rightarrow V$  that is rank one, the map given by composing the operator with itself  $t \circ t: V \rightarrow V$  satisfies  $t \circ t = r \cdot t$  for some real number  $r$ .

- 2.40 Let  $h: V \rightarrow \mathbb{R}$  be a homomorphism, but not the zero homomorphism. Prove that if  $\langle \vec{\beta}_1, \dots, \vec{\beta}_n \rangle$  is a basis for the nullspace and if  $\vec{v} \in V$  is not in the nullspace then  $\langle \vec{v}, \vec{\beta}_1, \dots, \vec{\beta}_n \rangle$  is a basis for the entire domain  $V$ .

- 2.41 Show that for any space  $V$  of dimension  $n$ , the *dual space*

$$\mathcal{L}(V, \mathbb{R}) = \{h: V \rightarrow \mathbb{R} \mid h \text{ is linear}\}$$

is isomorphic to  $\mathbb{R}^n$ . It is often denoted  $V^*$ . Conclude that  $V^* \cong V$ .

- 2.42 Show that any linear map is the sum of maps of rank one.

- 2.43 Is 'is homomorphic to' an equivalence relation? (*Hint*: the difficulty is to decide on an appropriate meaning for the quoted phrase.)

- 2.44 Show that the rangespaces and nullspaces of powers of linear maps  $t: V \rightarrow V$  form descending

$$V \supseteq \mathcal{R}(t) \supseteq \mathcal{R}(t^2) \supseteq \dots$$

and ascending

$$\{\vec{0}\} \subseteq \mathcal{N}(t) \subseteq \mathcal{N}(t^2) \subseteq \dots$$

chains. Also show that if  $k$  is such that  $\mathcal{R}(t^k) = \mathcal{R}(t^{k+1})$  then all following rangespaces are equal:  $\mathcal{R}(t^k) = \mathcal{R}(t^{k+1}) = \mathcal{R}(t^{k+2}) \dots$ . Similarly, if  $\mathcal{N}(t^k) = \mathcal{N}(t^{k+1})$  then  $\mathcal{N}(t^k) = \mathcal{N}(t^{k+1}) = \mathcal{N}(t^{k+2}) = \dots$ .

### III Computing Linear Maps

The prior section shows that a linear map is determined by its action on a basis. The equation

$$h(\vec{v}) = h(c_1 \cdot \vec{\beta}_1 + \cdots + c_n \cdot \vec{\beta}_n) = c_1 \cdot h(\vec{\beta}_1) + \cdots + c_n \cdot h(\vec{\beta}_n)$$

describes how from the value of the map on the vectors  $\vec{\beta}_i$  in a basis we can extend linearly to get the value of the map on any vector  $\vec{v}$  at all.

This section gives a convenient scheme to use the representations of  $h(\vec{\beta}_1)$ ,  $\dots$ ,  $h(\vec{\beta}_n)$  to compute, from the representation of a vector in the domain  $\text{Rep}_B(\vec{v})$ , the representation of that vector's image in the codomain  $\text{Rep}_D(h(\vec{v}))$ .

#### III.1 Representing Linear Maps with Matrices

**1.1 Example** For the spaces  $\mathbb{R}^2$  and  $\mathbb{R}^3$  fix

$$B = \left\langle \begin{pmatrix} 2 \\ 0 \end{pmatrix}, \begin{pmatrix} 1 \\ 4 \end{pmatrix} \right\rangle \quad \text{and} \quad D = \left\langle \begin{pmatrix} 1 \\ 0 \\ 0 \end{pmatrix}, \begin{pmatrix} 0 \\ -2 \\ 0 \end{pmatrix}, \begin{pmatrix} 1 \\ 0 \\ 1 \end{pmatrix} \right\rangle$$

as the bases. Consider the map  $h: \mathbb{R}^2 \rightarrow \mathbb{R}^3$  with this action.

$$\begin{pmatrix} 2 \\ 0 \end{pmatrix} \xrightarrow{h} \begin{pmatrix} 1 \\ 1 \\ 1 \end{pmatrix} \quad \begin{pmatrix} 1 \\ 4 \end{pmatrix} \xrightarrow{h} \begin{pmatrix} 1 \\ 2 \\ 0 \end{pmatrix}$$

To compute the action of this map on any vector at all from the domain, we first express  $h(\vec{\beta}_1)$

$$\begin{pmatrix} 1 \\ 1 \\ 1 \end{pmatrix} = 0 \begin{pmatrix} 1 \\ 0 \\ 0 \end{pmatrix} - \frac{1}{2} \begin{pmatrix} 0 \\ -2 \\ 0 \end{pmatrix} + 1 \begin{pmatrix} 1 \\ 0 \\ 1 \end{pmatrix} \quad \text{so} \quad \text{Rep}_D(h(\vec{\beta}_1)) = \begin{pmatrix} 0 \\ -1/2 \\ 1 \end{pmatrix}_D$$

and  $h(\vec{\beta}_2)$

$$\begin{pmatrix} 1 \\ 2 \\ 0 \end{pmatrix} = 1 \begin{pmatrix} 1 \\ 0 \\ 0 \end{pmatrix} - 1 \begin{pmatrix} 0 \\ -2 \\ 0 \end{pmatrix} + 0 \begin{pmatrix} 1 \\ 0 \\ 1 \end{pmatrix} \quad \text{so} \quad \text{Rep}_D(h(\vec{\beta}_2)) = \begin{pmatrix} 1 \\ -1 \\ 0 \end{pmatrix}_D$$

with respect to the codomain's basis. Then for any member  $\vec{v}$  of the domain we can compute  $h(\vec{v})$  using the  $h(\vec{\beta}_i)$ 's.

$$\begin{aligned} h(\vec{v}) &= h\left(c_1 \cdot \begin{pmatrix} 2 \\ 0 \end{pmatrix} + c_2 \cdot \begin{pmatrix} 1 \\ 4 \end{pmatrix}\right) \\ &= c_1 \cdot h\left(\begin{pmatrix} 2 \\ 0 \end{pmatrix}\right) + c_2 \cdot h\left(\begin{pmatrix} 1 \\ 4 \end{pmatrix}\right) \\ &= c_1 \cdot \left(0 \begin{pmatrix} 1 \\ 0 \\ 0 \end{pmatrix} - \frac{1}{2} \begin{pmatrix} 0 \\ -2 \\ 0 \end{pmatrix} + 1 \begin{pmatrix} 1 \\ 0 \\ 1 \end{pmatrix}\right) + c_2 \cdot \left(1 \begin{pmatrix} 1 \\ 0 \\ 0 \end{pmatrix} - 1 \begin{pmatrix} 0 \\ -2 \\ 0 \end{pmatrix} + 0 \begin{pmatrix} 1 \\ 0 \\ 1 \end{pmatrix}\right) \\ &= (0c_1 + 1c_2) \cdot \begin{pmatrix} 1 \\ 0 \\ 0 \end{pmatrix} + \left(-\frac{1}{2}c_1 - 1c_2\right) \cdot \begin{pmatrix} 0 \\ -2 \\ 0 \end{pmatrix} + (1c_1 + 0c_2) \cdot \begin{pmatrix} 1 \\ 0 \\ 1 \end{pmatrix} \end{aligned}$$

Thus,

$$\text{if } \text{Rep}_B(\vec{v}) = \begin{pmatrix} c_1 \\ c_2 \end{pmatrix} \text{ then } \text{Rep}_D(h(\vec{v})) = \begin{pmatrix} 0c_1 + 1c_2 \\ -(1/2)c_1 - 1c_2 \\ 1c_1 + 0c_2 \end{pmatrix}.$$

For instance,

$$\text{since } \text{Rep}_B\left(\begin{pmatrix} 4 \\ 8 \end{pmatrix}\right) = \begin{pmatrix} 1 \\ 2 \end{pmatrix}_B \text{ we have } \text{Rep}_D\left(h\left(\begin{pmatrix} 4 \\ 8 \end{pmatrix}\right)\right) = \begin{pmatrix} 2 \\ -5/2 \\ 1 \end{pmatrix}.$$

We express computations like the one above with a matrix notation.

$$\begin{pmatrix} 0 & 1 \\ -1/2 & -1 \\ 1 & 0 \end{pmatrix}_{B,D} \begin{pmatrix} c_1 \\ c_2 \end{pmatrix}_B = \begin{pmatrix} 0c_1 + 1c_2 \\ (-1/2)c_1 - 1c_2 \\ 1c_1 + 0c_2 \end{pmatrix}_D$$

In the middle is the argument  $\vec{v}$  to the map, represented with respect to the domain's basis B by the column vector with components  $c_1$  and  $c_2$ . On the right is the value of the map on that argument  $h(\vec{v})$ , represented with respect to the codomain's basis D. The matrix on the left is the new thing. We will use it to represent the map and we will think of the above equation as representing an application of the map to the matrix.

That matrix consists of the coefficients from the vector on the right, 0 and 1 from the first row,  $-1/2$  and  $-1$  from the second row, and 1 and 0 from the third row. That is, we make it by adjoining the vectors representing the  $h(\vec{\beta}_i)$ 's.

$$\left( \begin{array}{c|c} \vdots & \vdots \\ \text{Rep}_D(h(\vec{\beta}_1)) & \text{Rep}_D(h(\vec{\beta}_2)) \\ \vdots & \vdots \end{array} \right)$$

**1.2 Definition** Suppose that  $V$  and  $W$  are vector spaces of dimensions  $n$  and  $m$  with bases  $B$  and  $D$ , and that  $h: V \rightarrow W$  is a linear map. If

$$\text{Rep}_D(h(\vec{\beta}_1)) = \begin{pmatrix} h_{1,1} \\ h_{2,1} \\ \vdots \\ h_{m,1} \end{pmatrix}_D \quad \dots \quad \text{Rep}_D(h(\vec{\beta}_n)) = \begin{pmatrix} h_{1,n} \\ h_{2,n} \\ \vdots \\ h_{m,n} \end{pmatrix}_D$$

then

$$\text{Rep}_{B,D}(h) = \begin{pmatrix} h_{1,1} & h_{1,2} & \dots & h_{1,n} \\ h_{2,1} & h_{2,2} & \dots & h_{2,n} \\ \vdots & \vdots & \ddots & \vdots \\ h_{m,1} & h_{m,2} & \dots & h_{m,n} \end{pmatrix}_{B,D}$$

is the *matrix representation of  $h$  with respect to  $B, D$* .

In that matrix the number of columns  $n$  is the dimension of the map's domain while the number of rows  $m$  is the dimension of the codomain.

We use lower case letters for a map, upper case for the matrix, and lower case again for the entries of the matrix. Thus for the map  $h$ , the matrix representing it is  $H$ , with entries  $h_{i,j}$ .

**1.3 Example** If  $h: \mathbb{R}^3 \rightarrow \mathcal{P}_1$  is

$$\begin{pmatrix} a_1 \\ a_2 \\ a_3 \end{pmatrix} \xrightarrow{h} (2a_1 + a_2) + (-a_3)x$$

then where

$$B = \left\langle \begin{pmatrix} 0 \\ 0 \\ 1 \end{pmatrix}, \begin{pmatrix} 0 \\ 2 \\ 0 \end{pmatrix}, \begin{pmatrix} 2 \\ 0 \\ 0 \end{pmatrix} \right\rangle \quad \text{and} \quad D = \langle 1 + x, -1 + x \rangle$$

the action of  $h$  on  $B$  is this.

$$\begin{pmatrix} 0 \\ 0 \\ 1 \end{pmatrix} \xrightarrow{h} -x \quad \begin{pmatrix} 0 \\ 2 \\ 0 \end{pmatrix} \xrightarrow{h} 2 \quad \begin{pmatrix} 2 \\ 0 \\ 0 \end{pmatrix} \xrightarrow{h} 4$$

A simple calculation

$$\text{Rep}_D(-x) = \begin{pmatrix} -1/2 \\ -1/2 \end{pmatrix}_D \quad \text{Rep}_D(2) = \begin{pmatrix} 1 \\ -1 \end{pmatrix}_D \quad \text{Rep}_D(4) = \begin{pmatrix} 2 \\ -2 \end{pmatrix}_D$$

shows that this is the matrix representing  $h$  with respect to the bases.

$$\text{Rep}_{B,D}(h) = \begin{pmatrix} -1/2 & 1 & 2 \\ -1/2 & -1 & -2 \end{pmatrix}_{B,D}$$

**1.4 Theorem** Assume that  $V$  and  $W$  are vector spaces of dimensions  $n$  and  $m$  with bases  $B$  and  $D$ , and that  $h: V \rightarrow W$  is a linear map. If  $h$  is represented by

$$\text{Rep}_{B,D}(h) = \begin{pmatrix} h_{1,1} & h_{1,2} & \cdots & h_{1,n} \\ h_{2,1} & h_{2,2} & \cdots & h_{2,n} \\ \vdots & \vdots & \ddots & \vdots \\ h_{m,1} & h_{m,2} & \cdots & h_{m,n} \end{pmatrix}_{B,D}$$

and  $\vec{v} \in V$  is represented by

$$\text{Rep}_B(\vec{v}) = \begin{pmatrix} c_1 \\ c_2 \\ \vdots \\ c_n \end{pmatrix}_B$$

then the representation of the image of  $\vec{v}$  is this.

$$\text{Rep}_D(h(\vec{v})) = \begin{pmatrix} h_{1,1}c_1 + h_{1,2}c_2 + \cdots + h_{1,n}c_n \\ h_{2,1}c_1 + h_{2,2}c_2 + \cdots + h_{2,n}c_n \\ \vdots \\ h_{m,1}c_1 + h_{m,2}c_2 + \cdots + h_{m,n}c_n \end{pmatrix}_D$$

**PROOF** This formalizes Example 1.1; see Exercise 29.

QED

**1.5 Definition** The *matrix-vector product* of a  $m \times n$  matrix and a  $n \times 1$  vector is this.

$$\begin{pmatrix} a_{1,1} & a_{1,2} & \cdots & a_{1,n} \\ a_{2,1} & a_{2,2} & \cdots & a_{2,n} \\ \vdots & \vdots & \ddots & \vdots \\ a_{m,1} & a_{m,2} & \cdots & a_{m,n} \end{pmatrix} \begin{pmatrix} c_1 \\ \vdots \\ c_n \end{pmatrix} = \begin{pmatrix} a_{1,1}c_1 + a_{1,2}c_2 + \cdots + a_{1,n}c_n \\ a_{2,1}c_1 + a_{2,2}c_2 + \cdots + a_{2,n}c_n \\ \vdots \\ a_{m,1}c_1 + a_{m,2}c_2 + \cdots + a_{m,n}c_n \end{pmatrix}$$

Briefly, application of a linear map is represented by the matrix-vector product of the map's representative and the vector's representative.

**1.6 Remark** In some sense Theorem 1.4 is not at all surprising because we chose the matrix representative in Definition 1.2 precisely to make Theorem 1.4 true. If the theorem were not true then we would adjust the definition. Nonetheless, we need the verification that the definition is right.

**1.7 Example** For the matrix from Example 1.3 we can calculate where that map sends this vector.

$$\vec{v} = \begin{pmatrix} 4 \\ 1 \\ 0 \end{pmatrix}$$



With respect to the domain basis  $B$  the representation of this vector is

$$\text{Rep}_B(\vec{v}) = \begin{pmatrix} 0 \\ 1/2 \\ 2 \end{pmatrix}_B$$

and so the matrix-vector product gives the representation of the value  $h(\vec{v})$  with respect to the codomain basis  $D$ .

$$\begin{aligned} \text{Rep}_D(h(\vec{v})) &= \begin{pmatrix} -1/2 & 1 & 2 \\ -1/2 & -1 & -2 \end{pmatrix}_{B,D} \begin{pmatrix} 0 \\ 1/2 \\ 2 \end{pmatrix}_B \\ &= \begin{pmatrix} (-1/2) \cdot 0 + 1 \cdot (1/2) + 2 \cdot 2 \\ (-1/2) \cdot 0 - 1 \cdot (1/2) - 2 \cdot 2 \end{pmatrix}_D = \begin{pmatrix} 9/2 \\ -9/2 \end{pmatrix}_D \end{aligned}$$

To find  $h(\vec{v})$  itself, not its representation, take  $(9/2)(1+x) - (9/2)(-1+x) = 9$ .

**1.8 Example** Let  $\pi: \mathbb{R}^3 \rightarrow \mathbb{R}^2$  be projection onto the  $xy$ -plane. To give a matrix representing this map, we first fix some bases.

$$B = \left\langle \begin{pmatrix} 1 \\ 0 \\ 0 \end{pmatrix}, \begin{pmatrix} 1 \\ 1 \\ 0 \end{pmatrix}, \begin{pmatrix} -1 \\ 0 \\ 1 \end{pmatrix} \right\rangle \quad D = \left\langle \begin{pmatrix} 2 \\ 1 \end{pmatrix}, \begin{pmatrix} 1 \\ 1 \end{pmatrix} \right\rangle$$

For each vector in the domain's basis, we find its image under the map.

$$\begin{pmatrix} 1 \\ 0 \\ 0 \end{pmatrix} \xrightarrow{\pi} \begin{pmatrix} 1 \\ 0 \end{pmatrix} \quad \begin{pmatrix} 1 \\ 1 \\ 0 \end{pmatrix} \xrightarrow{\pi} \begin{pmatrix} 1 \\ 1 \end{pmatrix} \quad \begin{pmatrix} -1 \\ 0 \\ 1 \end{pmatrix} \xrightarrow{\pi} \begin{pmatrix} -1 \\ 0 \end{pmatrix}$$

Then we find the representation of each image with respect to the codomain's basis.

$$\text{Rep}_D\left(\begin{pmatrix} 1 \\ 0 \end{pmatrix}\right) = \begin{pmatrix} 1 \\ -1 \end{pmatrix} \quad \text{Rep}_D\left(\begin{pmatrix} 1 \\ 1 \end{pmatrix}\right) = \begin{pmatrix} 0 \\ 1 \end{pmatrix} \quad \text{Rep}_D\left(\begin{pmatrix} -1 \\ 0 \end{pmatrix}\right) = \begin{pmatrix} -1 \\ 1 \end{pmatrix}$$

Finally, adjoining these representations gives the matrix representing  $\pi$  with respect to  $B, D$ .

$$\text{Rep}_{B,D}(\pi) = \begin{pmatrix} 1 & 0 & -1 \\ -1 & 1 & 1 \end{pmatrix}_{B,D}$$

We can illustrate Theorem 1.4 by computing the matrix-vector product representing the following statement about the projection map.

$$\pi\left(\begin{pmatrix} 2 \\ 2 \\ 1 \end{pmatrix}\right) = \begin{pmatrix} 2 \\ 2 \end{pmatrix}$$

Representing this vector from the domain with respect to the domain's basis

$$\text{Rep}_B \left( \begin{pmatrix} 2 \\ 2 \\ 1 \end{pmatrix} \right) = \begin{pmatrix} 1 \\ 2 \\ 1 \end{pmatrix}_B$$

gives this matrix-vector product.

$$\text{Rep}_D \left( \pi \left( \begin{pmatrix} 2 \\ 2 \\ 1 \end{pmatrix} \right) \right) = \begin{pmatrix} 1 & 0 & -1 \\ -1 & 1 & 1 \end{pmatrix}_{B,D} \begin{pmatrix} 1 \\ 2 \\ 1 \end{pmatrix}_B = \begin{pmatrix} 0 \\ 2 \end{pmatrix}_D$$

Expanding this representation into a linear combination of vectors from D

$$0 \cdot \begin{pmatrix} 2 \\ 1 \end{pmatrix} + 2 \cdot \begin{pmatrix} 1 \\ 1 \end{pmatrix} = \begin{pmatrix} 2 \\ 2 \end{pmatrix}$$

checks that the map's action is indeed reflected in the operation of the matrix. (We will sometimes compress these three displayed equations into one

$$\begin{pmatrix} 2 \\ 2 \\ 1 \end{pmatrix} = \begin{pmatrix} 1 \\ 2 \\ 1 \end{pmatrix}_B \xrightarrow[\text{H}]{\text{h}} \begin{pmatrix} 0 \\ 2 \end{pmatrix}_D = \begin{pmatrix} 2 \\ 2 \end{pmatrix}$$

in the course of a calculation.)

We now have two ways to compute the effect of projection, the straightforward formula that drops each three-tall vector's third component to make a two-tall vector, and the above formula that uses representations and matrix-vector multiplication. Compared to the first way, the second way might seem complicated. However, it has advantages. The next example shows that this new scheme simplifies the formula for some maps.

**1.9 Example** To represent a *rotation* map  $t_\theta: \mathbb{R}^2 \rightarrow \mathbb{R}^2$  that turns all vectors in the plane counterclockwise through an angle  $\theta$

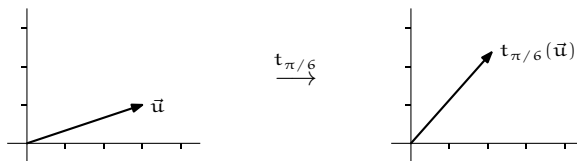

we start by fixing bases. Using  $\mathcal{E}_2$  both as a domain basis and as a codomain basis is natural. Now, we find the image under the map of each vector in the domain's basis.

$$\begin{pmatrix} 1 \\ 0 \end{pmatrix} \xrightarrow{t_\theta} \begin{pmatrix} \cos \theta \\ \sin \theta \end{pmatrix} \quad \begin{pmatrix} 0 \\ 1 \end{pmatrix} \xrightarrow{t_\theta} \begin{pmatrix} -\sin \theta \\ \cos \theta \end{pmatrix}$$

Then we represent these images with respect to the codomain's basis. Because this basis is  $\mathcal{E}_2$ , vectors represent themselves. Adjoining the representations

gives the matrix representing the map.

$$\text{Rep}_{\varepsilon_2, \varepsilon_2}(t_\theta) = \begin{pmatrix} \cos \theta & -\sin \theta \\ \sin \theta & \cos \theta \end{pmatrix}$$

The advantage of this scheme is that by knowing how to represent the image of just the two basis vectors we get a formula for the image of any vector at all; here we rotate a vector by  $\theta = \pi/6$ .

$$\begin{pmatrix} 3 \\ -2 \end{pmatrix} \xrightarrow{t_{\pi/6}} \begin{pmatrix} \sqrt{3}/2 & -1/2 \\ 1/2 & \sqrt{3}/2 \end{pmatrix} \begin{pmatrix} 3 \\ -2 \end{pmatrix} \approx \begin{pmatrix} 3.598 \\ -0.232 \end{pmatrix}$$

(We are again using the fact that with respect to the standard basis, vectors represent themselves.)

**1.10 Example** In the definition of matrix-vector product the width of the matrix equals the height of the vector. Hence, the first product below is defined while the second is not.

$$\begin{pmatrix} 1 & 0 & 0 \\ 4 & 3 & 1 \end{pmatrix} \begin{pmatrix} 1 \\ 0 \\ 2 \end{pmatrix} \quad \begin{pmatrix} 1 & 0 & 0 \\ 4 & 3 & 1 \end{pmatrix} \begin{pmatrix} 1 \\ 0 \end{pmatrix}$$

One reason that this product is not defined is the purely formal one that the definition requires that the sizes match and these sizes don't match. Behind the formality, though, is a sensible reason to leave it undefined: the three-wide matrix represents a map with a three-dimensional domain while the two-tall vector represents a member of a two-dimensional space.

Earlier we saw the operations of addition and scalar multiplication operations of matrices and the dot product of vectors. Matrix-vector multiplication is a new operation in the arithmetic of vectors and matrices. Nothing in Definition 1.5 requires us to view it in terms of representations. We can get some insight by focusing on how the entries combine.

A good way to view matrix-vector product is as the dot products of the rows of the matrix with the column vector.

$$\begin{pmatrix} \vdots \\ a_{i,1} & a_{i,2} & \dots & a_{i,n} \\ \vdots \end{pmatrix} \begin{pmatrix} c_1 \\ c_2 \\ \vdots \\ c_n \end{pmatrix} = \begin{pmatrix} \vdots \\ a_{i,1}c_1 + a_{i,2}c_2 + \dots + a_{i,n}c_n \\ \vdots \end{pmatrix}$$

Looked at in this row-by-row way, this new operation generalizes dot product.

We can also view the operation column-by-column.

$$\begin{aligned} \begin{pmatrix} h_{1,1} & h_{1,2} & \cdots & h_{1,n} \\ h_{2,1} & h_{2,2} & \cdots & h_{2,n} \\ \vdots & \vdots & \ddots & \vdots \\ h_{m,1} & h_{m,2} & \cdots & h_{m,n} \end{pmatrix} \begin{pmatrix} c_1 \\ c_2 \\ \vdots \\ c_n \end{pmatrix} &= \begin{pmatrix} h_{1,1}c_1 + h_{1,2}c_2 + \cdots + h_{1,n}c_n \\ h_{2,1}c_1 + h_{2,2}c_2 + \cdots + h_{2,n}c_n \\ \vdots \\ h_{m,1}c_1 + h_{m,2}c_2 + \cdots + h_{m,n}c_n \end{pmatrix} \\ &= c_1 \begin{pmatrix} h_{1,1} \\ h_{2,1} \\ \vdots \\ h_{m,1} \end{pmatrix} + \cdots + c_n \begin{pmatrix} h_{1,n} \\ h_{2,n} \\ \vdots \\ h_{m,n} \end{pmatrix} \end{aligned}$$

### 1.11 Example

$$\begin{pmatrix} 1 & 0 & -1 \\ 2 & 0 & 3 \end{pmatrix} \begin{pmatrix} 2 \\ -1 \\ 1 \end{pmatrix} = 2 \begin{pmatrix} 1 \\ 2 \end{pmatrix} - 1 \begin{pmatrix} 0 \\ 0 \end{pmatrix} + 1 \begin{pmatrix} -1 \\ 3 \end{pmatrix} = \begin{pmatrix} 1 \\ 7 \end{pmatrix}$$

The result has the columns of the matrix weighted by the entries of the vector. This way of looking at it brings us back to the objective stated at the start of this section, to compute  $h(c_1\vec{\beta}_1 + \cdots + c_n\vec{\beta}_n)$  as  $c_1h(\vec{\beta}_1) + \cdots + c_nh(\vec{\beta}_n)$ .

We began this section by noting that the equality of these two enables us to compute the action of  $h$  on any argument knowing only  $h(\vec{\beta}_1), \dots, h(\vec{\beta}_n)$ . We have developed this into a scheme to compute the action of the map by taking the matrix-vector product of the matrix representing the map with the vector representing the argument. In this way, with respect to any bases, any linear map has a matrix representing it. The next subsection will show the converse, that if we fix bases then for any matrix there is an associated linear map.

### Exercises

✓ **1.12** Multiply the matrix

$$\begin{pmatrix} 1 & 3 & 1 \\ 0 & -1 & 2 \\ 1 & 1 & 0 \end{pmatrix}$$

by each vector (or state “not defined”).

$$\text{(a)} \begin{pmatrix} 2 \\ 1 \\ 0 \end{pmatrix} \quad \text{(b)} \begin{pmatrix} -2 \\ -2 \end{pmatrix} \quad \text{(c)} \begin{pmatrix} 0 \\ 0 \\ 0 \end{pmatrix}$$

**1.13** Perform, if possible, each matrix-vector multiplication.

$$\text{(a)} \begin{pmatrix} 2 & 1 \\ 3 & -1/2 \end{pmatrix} \begin{pmatrix} 4 \\ 2 \end{pmatrix} \quad \text{(b)} \begin{pmatrix} 1 & 1 & 0 \\ -2 & 1 & 0 \end{pmatrix} \begin{pmatrix} 1 \\ 3 \\ 1 \end{pmatrix} \quad \text{(c)} \begin{pmatrix} 1 & 1 \\ -2 & 1 \end{pmatrix} \begin{pmatrix} 1 \\ 3 \\ 1 \end{pmatrix}$$

✓ **1.14** Solve this matrix equation.

$$\begin{pmatrix} 2 & 1 & 1 \\ 0 & 1 & 3 \\ 1 & -1 & 2 \end{pmatrix} \begin{pmatrix} x \\ y \\ z \end{pmatrix} = \begin{pmatrix} 8 \\ 4 \\ 4 \end{pmatrix}$$

- ✓ 1.15 For a homomorphism from  $\mathcal{P}_2$  to  $\mathcal{P}_3$  that sends

$$1 \mapsto 1 + x, \quad x \mapsto 1 + 2x, \quad \text{and} \quad x^2 \mapsto x - x^3$$

where does  $1 - 3x + 2x^2$  go?

- ✓ 1.16 Assume that  $h: \mathbb{R}^2 \rightarrow \mathbb{R}^3$  is determined by this action.

$$\begin{pmatrix} 1 \\ 0 \end{pmatrix} \mapsto \begin{pmatrix} 2 \\ 2 \\ 0 \end{pmatrix} \quad \begin{pmatrix} 0 \\ 1 \end{pmatrix} \mapsto \begin{pmatrix} 0 \\ 1 \\ -1 \end{pmatrix}$$

Using the standard bases, find

- (a) the matrix representing this map;  
 (b) a general formula for  $h(\vec{v})$ .
- ✓ 1.17 Let  $d/dx: \mathcal{P}_3 \rightarrow \mathcal{P}_3$  be the derivative transformation.
- (a) Represent  $d/dx$  with respect to  $B, B$  where  $B = \langle 1, x, x^2, x^3 \rangle$ .  
 (b) Represent  $d/dx$  with respect to  $B, D$  where  $D = \langle 1, 2x, 3x^2, 4x^3 \rangle$ .
- ✓ 1.18 Represent each linear map with respect to each pair of bases.
- (a)  $d/dx: \mathcal{P}_n \rightarrow \mathcal{P}_n$  with respect to  $B, B$  where  $B = \langle 1, x, \dots, x^n \rangle$ , given by  
 $a_0 + a_1x + a_2x^2 + \dots + a_nx^n \mapsto a_1 + 2a_2x + \dots + na_nx^{n-1}$
- (b)  $\int: \mathcal{P}_n \rightarrow \mathcal{P}_{n+1}$  with respect to  $B_n, B_{n+1}$  where  $B_i = \langle 1, x, \dots, x^i \rangle$ , given by  
 $a_0 + a_1x + a_2x^2 + \dots + a_nx^n \mapsto a_0x + \frac{a_1}{2}x^2 + \dots + \frac{a_n}{n+1}x^{n+1}$
- (c)  $\int_0^1: \mathcal{P}_n \rightarrow \mathbb{R}$  with respect to  $B, \mathcal{E}_1$  where  $B = \langle 1, x, \dots, x^n \rangle$  and  $\mathcal{E}_1 = \langle 1 \rangle$ , given by  
 $a_0 + a_1x + a_2x^2 + \dots + a_nx^n \mapsto a_0 + \frac{a_1}{2} + \dots + \frac{a_n}{n+1}$
- (d)  $\text{eval}_3: \mathcal{P}_n \rightarrow \mathbb{R}$  with respect to  $B, \mathcal{E}_1$  where  $B = \langle 1, x, \dots, x^n \rangle$  and  $\mathcal{E}_1 = \langle 1 \rangle$ , given by  
 $a_0 + a_1x + a_2x^2 + \dots + a_nx^n \mapsto a_0 + a_1 \cdot 3 + a_2 \cdot 3^2 + \dots + a_n \cdot 3^n$
- (e)  $\text{slide}_{-1}: \mathcal{P}_n \rightarrow \mathcal{P}_n$  with respect to  $B, B$  where  $B = \langle 1, x, \dots, x^n \rangle$ , given by  
 $a_0 + a_1x + a_2x^2 + \dots + a_nx^n \mapsto a_0 + a_1 \cdot (x+1) + \dots + a_n \cdot (x+1)^n$

1.19 Represent the identity map on any nontrivial space with respect to  $B, B$ , where  $B$  is any basis.

1.20 Represent, with respect to the natural basis, the transpose transformation on the space  $\mathcal{M}_{2 \times 2}$  of  $2 \times 2$  matrices.

1.21 Assume that  $B = \langle \vec{\beta}_1, \vec{\beta}_2, \vec{\beta}_3, \vec{\beta}_4 \rangle$  is a basis for a vector space. Represent with respect to  $B, B$  the transformation that is determined by each.

(a)  $\vec{\beta}_1 \mapsto \vec{\beta}_2, \vec{\beta}_2 \mapsto \vec{\beta}_3, \vec{\beta}_3 \mapsto \vec{\beta}_4, \vec{\beta}_4 \mapsto \vec{0}$

(b)  $\vec{\beta}_1 \mapsto \vec{\beta}_2, \vec{\beta}_2 \mapsto \vec{0}, \vec{\beta}_3 \mapsto \vec{\beta}_4, \vec{\beta}_4 \mapsto \vec{0}$

(c)  $\vec{\beta}_1 \mapsto \vec{\beta}_2, \vec{\beta}_2 \mapsto \vec{\beta}_3, \vec{\beta}_3 \mapsto \vec{0}, \vec{\beta}_4 \mapsto \vec{0}$

1.22 Example 1.9 shows how to represent the rotation transformation of the plane with respect to the standard basis. Express these other transformations also with respect to the standard basis.

(a) the *dilation* map  $d_s$ , which multiplies all vectors by the same scalar  $s$

(b) the *reflection* map  $f_\ell$ , which reflects all all vectors across a line  $\ell$  through the origin

- ✓ 1.23 Consider a linear transformation of  $\mathbb{R}^2$  determined by these two.

$$\begin{pmatrix} 1 \\ 1 \end{pmatrix} \mapsto \begin{pmatrix} 2 \\ 0 \end{pmatrix} \quad \begin{pmatrix} 1 \\ 0 \end{pmatrix} \mapsto \begin{pmatrix} -1 \\ 0 \end{pmatrix}$$

- (a) Represent this transformation with respect to the standard bases.

- (b) Where does the transformation send this vector?

$$\begin{pmatrix} 0 \\ 5 \end{pmatrix}$$

- (c) Represent this transformation with respect to these bases.

$$B = \left\langle \begin{pmatrix} 1 \\ -1 \end{pmatrix}, \begin{pmatrix} 1 \\ 1 \end{pmatrix} \right\rangle \quad D = \left\langle \begin{pmatrix} 2 \\ 2 \end{pmatrix}, \begin{pmatrix} -1 \\ 1 \end{pmatrix} \right\rangle$$

- (d) Using
- $B$
- from the prior item, represent the transformation with respect to
- $B, B$
- .

1.24 Suppose that  $h: V \rightarrow W$  is one-to-one so that by Theorem 2.20, for any basis  $B = \langle \vec{\beta}_1, \dots, \vec{\beta}_n \rangle \subset V$  the image  $h(B) = \langle h(\vec{\beta}_1), \dots, h(\vec{\beta}_n) \rangle$  is a basis for  $W$ .

- (a) Represent the map
- $h$
- with respect to
- $B, h(B)$
- .

- (b) For a member
- $\vec{v}$
- of the domain, where the representation of
- $\vec{v}$
- has components
- $c_1, \dots, c_n$
- , represent the image vector
- $h(\vec{v})$
- with respect to the image basis
- $h(B)$
- .

1.25 Give a formula for the product of a matrix and  $\vec{e}_i$ , the column vector that is all zeroes except for a single one in the  $i$ -th position.

- ✓ 1.26 For each vector space of functions of one real variable, represent the derivative transformation with respect to  $B, B$ .

- (a)
- $\{a \cos x + b \sin x \mid a, b \in \mathbb{R}\}$
- ,
- $B = \langle \cos x, \sin x \rangle$

- (b)
- $\{ae^x + be^{2x} \mid a, b \in \mathbb{R}\}$
- ,
- $B = \langle e^x, e^{2x} \rangle$

- (c)
- $\{a + bx + ce^x + dx e^x \mid a, b, c, d \in \mathbb{R}\}$
- ,
- $B = \langle 1, x, e^x, x e^x \rangle$

1.27 Find the range of the linear transformation of  $\mathbb{R}^2$  represented with respect to the standard bases by each matrix.

$$(a) \begin{pmatrix} 1 & 0 \\ 0 & 0 \end{pmatrix} \quad (b) \begin{pmatrix} 0 & 0 \\ 3 & 2 \end{pmatrix} \quad (c) \text{ a matrix of the form } \begin{pmatrix} a & b \\ 2a & 2b \end{pmatrix}$$

- ✓ 1.28 Can one matrix represent two different linear maps? That is, can  $\text{Rep}_{B,D}(h) = \text{Rep}_{\hat{B},\hat{D}}(\hat{h})$ ?

1.29 Prove Theorem 1.4.

- ✓ 1.30 Example 1.9 shows how to represent rotation of all vectors in the plane through an angle  $\theta$  about the origin, with respect to the standard bases.

- (a) Rotation of all vectors in three-space through an angle
- $\theta$
- about the
- $x$
- axis is a transformation of
- $\mathbb{R}^3$
- . Represent it with respect to the standard bases. Arrange the rotation so that to someone whose feet are at the origin and whose head is at
- $(1, 0, 0)$
- , the movement appears clockwise.

- (b) Repeat the prior item, only rotate about the
- $y$
- axis instead. (Put the person's head at
- $\vec{e}_2$
- .)

- (c) Repeat, about the
- $z$
- axis.

- (d) Extend the prior item to
- $\mathbb{R}^4$
- . (
- Hint:*
- we can restate 'rotate about the
- $z$
- axis' as 'rotate parallel to the
- $xy$
- plane'.)

1.31 (Schur's Triangularization Lemma)

- (a) Let
- $U$
- be a subspace of
- $V$
- and fix bases
- $B_U \subseteq B_V$
- . What is the relationship between the representation of a vector from
- $U$
- with respect to
- $B_U$
- and the representation of that vector (viewed as a member of
- $V$
- ) with respect to
- $B_V$
- ?

- (b) What about maps?

- (c) Fix a basis
- $B = \langle \vec{\beta}_1, \dots, \vec{\beta}_n \rangle$
- for
- $V$
- and observe that the spans

$$\{[\vec{0}]\} = \{[\vec{0}]\} \subset \{[\vec{\beta}_1]\} \subset \{[\vec{\beta}_1, \vec{\beta}_2]\} \subset \dots \subset [B] = V$$

form a strictly increasing chain of subspaces. Show that for any linear map  $h: V \rightarrow W$  there is a chain  $W_0 = \{[\vec{0}]\} \subseteq W_1 \subseteq \dots \subseteq W_m = W$  of subspaces of  $W$  such that

$$h(\{[\vec{\beta}_1, \dots, \vec{\beta}_i]\}) \subset W_i$$

for each  $i$ .

(d) Conclude that for every linear map  $h: V \rightarrow W$  there are bases  $B, D$  so the matrix representing  $h$  with respect to  $B, D$  is upper-triangular (that is, each entry  $h_{i,j}$  with  $i > j$  is zero).

(e) Is an upper-triangular representation unique?

## III.2 Any Matrix Represents a Linear Map

The prior subsection shows that the action of a linear map  $h$  is described by a matrix  $H$ , with respect to appropriate bases, in this way.

$$\vec{v} = \begin{pmatrix} v_1 \\ \vdots \\ v_n \end{pmatrix}_B \xrightarrow[H]{h} \begin{pmatrix} h_{1,1}v_1 + \cdots + h_{1,n}v_n \\ \vdots \\ h_{m,1}v_1 + \cdots + h_{m,n}v_n \end{pmatrix}_D = h(\vec{v})$$

In this subsection, we will show the converse, that each matrix represents a linear map.

Recall that, in the definition of the matrix representation of a linear map, the number of columns of the matrix is the dimension of the map's domain and the number of rows of the matrix is the dimension of the map's codomain. Thus, for instance, a  $2 \times 3$  matrix cannot represent a map with domain  $\mathbb{R}^5$  or codomain  $\mathbb{R}^4$ . The next result says that beyond this restriction on the dimensions there are no other limitations: the  $2 \times 3$  matrix represents a map from any three-dimensional space to any two-dimensional space.

**2.1 Theorem** Any matrix represents a homomorphism between vector spaces of appropriate dimensions, with respect to any pair of bases.

**PROOF** For the matrix

$$H = \begin{pmatrix} h_{1,1} & h_{1,2} & \cdots & h_{1,n} \\ h_{2,1} & h_{2,2} & \cdots & h_{2,n} \\ \vdots & \vdots & \ddots & \vdots \\ h_{m,1} & h_{m,2} & \cdots & h_{m,n} \end{pmatrix}$$

fix any  $n$ -dimensional domain space  $V$  and any  $m$ -dimensional codomain space  $W$ . Also fix bases  $B = \langle \vec{\beta}_1, \dots, \vec{\beta}_n \rangle$  and  $D = \langle \vec{\delta}_1, \dots, \vec{\delta}_m \rangle$  for those spaces. Define a function  $h: V \rightarrow W$  by: where  $\vec{v}$  in the domain has the representation

$$\text{Rep}_B(\vec{v}) = \begin{pmatrix} v_1 \\ \vdots \\ v_n \end{pmatrix}_B$$

then its image  $h(\vec{v})$  is the member the codomain represented in this way.

$$\text{Rep}_D(h(\vec{v})) = \begin{pmatrix} h_{1,1}v_1 + \cdots + h_{1,n}v_n \\ \vdots \\ h_{m,1}v_1 + \cdots + h_{m,n}v_n \end{pmatrix}_D$$

That is, for any  $\vec{v}$  in the domain, express it with respect to the basis as  $\vec{v} = v_1\vec{\beta}_1 + \cdots + v_n\vec{\beta}_n$  and then  $h(\vec{v})$  is  $(h_{1,1}v_1 + \cdots + h_{1,n}v_n) \cdot \vec{\delta}_1 + \cdots + (h_{m,1}v_1 + \cdots + h_{m,n}v_n) \cdot \vec{\delta}_m$ . (This is well-defined by the uniqueness of the representation  $\text{Rep}_B(\vec{v})$ .)

Observe that the definition simply makes  $h$  the map is represented with respect to  $B, D$  by the matrix  $H$ . So to finish we need only check that the defined map  $h$  is linear. If  $\vec{v}, \vec{u} \in V$  are such that

$$\text{Rep}_B(\vec{v}) = \begin{pmatrix} v_1 \\ \vdots \\ v_n \end{pmatrix} \quad \text{and} \quad \text{Rep}_B(\vec{u}) = \begin{pmatrix} u_1 \\ \vdots \\ u_n \end{pmatrix}$$

and  $c, d \in \mathbb{R}$  then the calculation

$$\begin{aligned} h(c\vec{v} + d\vec{u}) &= (h_{1,1}(cv_1 + du_1) + \cdots + h_{1,n}(cv_n + du_n)) \cdot \vec{\delta}_1 + \\ &\quad \cdots + (h_{m,1}(cv_1 + du_1) + \cdots + h_{m,n}(cv_n + du_n)) \cdot \vec{\delta}_m \\ &= c \cdot h(\vec{v}) + d \cdot h(\vec{u}) \end{aligned}$$

supplies this check. QED

**2.2 Example** The map that the matrix represents depends on the domain and codomain bases that we choose. If

$$H = \begin{pmatrix} 1 & 0 \\ 0 & 0 \end{pmatrix}, \quad B_1 = D_1 = \left\langle \begin{pmatrix} 1 \\ 0 \end{pmatrix}, \begin{pmatrix} 0 \\ 1 \end{pmatrix} \right\rangle, \quad \text{and} \quad B_2 = D_2 = \left\langle \begin{pmatrix} 0 \\ 1 \end{pmatrix}, \begin{pmatrix} 1 \\ 0 \end{pmatrix} \right\rangle,$$

then  $h_1: \mathbb{R}^2 \rightarrow \mathbb{R}^2$  represented by  $H$  with respect to  $B_1, D_1$  maps

$$\begin{pmatrix} c_1 \\ c_2 \end{pmatrix} = \begin{pmatrix} c_1 \\ c_2 \end{pmatrix}_{B_1} \quad \mapsto \quad \begin{pmatrix} c_1 \\ 0 \end{pmatrix}_{D_1} = \begin{pmatrix} c_1 \\ 0 \end{pmatrix}$$

while  $h_2: \mathbb{R}^2 \rightarrow \mathbb{R}^2$  represented by  $H$  with respect to  $B_2, D_2$  is this map.

$$\begin{pmatrix} c_1 \\ c_2 \end{pmatrix} = \begin{pmatrix} c_2 \\ c_1 \end{pmatrix}_{B_2} \quad \mapsto \quad \begin{pmatrix} c_2 \\ 0 \end{pmatrix}_{D_2} = \begin{pmatrix} 0 \\ c_2 \end{pmatrix}$$

These are different functions. The first is projection onto the  $x$ -axis, while the second is projection onto the  $y$ -axis.

This result means that we can, when convenient, work solely with matrices, just doing the computations without having to worry whether a matrix of interest represents a linear map on some pair of spaces. When we are working with a



matrix but we do not have particular spaces or bases in mind then we often take the domain and codomain to be  $\mathbb{R}^n$  and  $\mathbb{R}^m$  and use the standard bases. This is convenient because with the standard bases vector representation is transparent—the representation of  $\vec{v}$  is  $\vec{v}$ . (In this case the column space of the matrix equals the range of the map and consequently the column space of  $H$  is often denoted by  $\mathcal{R}(H)$ .)

We finish this section by illustrating how a matrix can give us information about the associated maps.

**2.3 Theorem** The rank of a matrix equals the rank of any map that it represents.

**PROOF** Suppose that the matrix  $H$  is  $m \times n$ . Fix domain and codomain spaces  $V$  and  $W$  of dimension  $n$  and  $m$  with bases  $B = \langle \vec{\beta}_1, \dots, \vec{\beta}_n \rangle$  and  $D$ . Then  $H$  represents some linear map  $h$  between those spaces with respect to these bases whose rangespace

$$\begin{aligned} \{h(\vec{v}) \mid \vec{v} \in V\} &= \{h(c_1\vec{\beta}_1 + \dots + c_n\vec{\beta}_n) \mid c_1, \dots, c_n \in \mathbb{R}\} \\ &= \{c_1h(\vec{\beta}_1) + \dots + c_nh(\vec{\beta}_n) \mid c_1, \dots, c_n \in \mathbb{R}\} \end{aligned}$$

is the span  $\{[h(\vec{\beta}_1), \dots, h(\vec{\beta}_n)]\}$ . The rank of the map  $h$  is the dimension of this rangespace.

The rank of the matrix is the dimension of its column space, the span of the set of its columns  $\{[\text{Rep}_D(h(\vec{\beta}_1)), \dots, \text{Rep}_D(h(\vec{\beta}_n))]\}$ .

To see that the two spans have the same dimension, recall from the proof of Lemma I.2.5 that if we fix a basis then representation with respect to that basis gives an isomorphism  $\text{Rep}_D: W \rightarrow \mathbb{R}^m$ . Under this isomorphism there is a linear relationship among members of the rangespace if and only if the same relationship holds in the column space, e.g.,  $\vec{0} = c_1h(\vec{\beta}_1) + \dots + c_nh(\vec{\beta}_n)$  if and only if  $\vec{0} = c_1\text{Rep}_D(h(\vec{\beta}_1)) + \dots + c_n\text{Rep}_D(h(\vec{\beta}_n))$ . Hence, a subset of the rangespace is linearly independent if and only if the corresponding subset of the column space is linearly independent. Therefore the size of the largest linearly independent subset of the rangespace equals the size of the largest linearly independent subset of the column space, and so the two spaces have the same dimension. QED

**2.4 Example** Any map represented by

$$\begin{pmatrix} 1 & 2 & 2 \\ 1 & 2 & 1 \\ 0 & 0 & 3 \\ 0 & 0 & 2 \end{pmatrix}$$

must be from a three-dimensional domain to a four-dimensional codomain. In addition, because the rank of this matrix is two (we can spot this by eye or get it with Gauss' method), any map represented by this matrix has a two-dimensional rangespace.

**2.5 Corollary** Let  $h$  be a linear map represented by a matrix  $H$ . Then  $h$  is onto if and only if the rank of  $H$  equals the number of its rows, and  $h$  is one-to-one if and only if the rank of  $H$  equals the number of its columns.

**PROOF** For the onto half, the dimension of the rangespace of  $h$  is the rank of  $h$ , which equals the rank of  $H$  by the theorem. Since the dimension of the codomain of  $h$  equals the number of rows in  $H$ , if the rank of  $H$  equals the number of rows then the dimension of the rangespace equals the dimension of the codomain. But a subspace with the same dimension as its superspace must equal that superspace (because any basis for the rangespace is a linearly independent subset of the codomain whose size is equal to the dimension of the codomain, and thus so this basis for the rangespace must also be a basis for the codomain).

For the other half, a linear map is one-to-one if and only if it is an isomorphism between its domain and its range, that is, if and only if its domain has the same dimension as its range. But the number of columns in  $h$  is the dimension of  $h$ 's domain, and by the theorem the rank of  $H$  equals the dimension of  $h$ 's range. QED

The above results settle the apparent ambiguity in our use of the same word 'rank' to apply both to matrices and to maps.

**2.6 Definition** A linear map that is one-to-one and onto is *nonsingular*, otherwise it is *singular*.

**2.7 Remark** Some authors use 'nonsingular' as a synonym for one-to-one while others use it the way that we have here, as a synonym for isomorphism. The difference is slight because a one-to-one map is onto its rangespace.

In the first chapter we defined a matrix to be nonsingular if it is square and is the matrix of coefficients of a linear system with a unique solution. The next result justifies our dual use of the term.

**2.8 Corollary** A square matrix represents nonsingular maps if and only if it is a nonsingular matrix. Thus, a matrix represents isomorphisms if and only if it is square and nonsingular.

**PROOF** Immediate from the prior result.

QED

**2.9 Example** Any map from  $\mathbb{R}^2$  to  $\mathcal{P}_1$  represented with respect to any pair of bases by

$$\begin{pmatrix} 1 & 2 \\ 0 & 3 \end{pmatrix}$$

is nonsingular because this matrix has rank two.

**2.10 Example** Any map  $g: V \rightarrow W$  represented by

$$\begin{pmatrix} 1 & 2 \\ 3 & 6 \end{pmatrix}$$

is singular because this matrix is singular.

We've now seen that the relationship between maps and matrices goes both ways: for a particular pair of bases, any linear map is represented by a matrix and any matrix describes a linear map. That is, by fixing spaces and bases we get a correspondence between maps and matrices. In the rest of this chapter we will explore this correspondence. For instance, we've defined for linear maps the operations of addition and scalar multiplication and we shall see what the corresponding matrix operations are. We shall also see the matrix operation that represent the map operation of composition. And, we shall see how to find the matrix that represents a map's inverse.

### Exercises

✓ 2.11 Decide if the vector is in the column space of the matrix.

$$(a) \begin{pmatrix} 2 & 1 \\ 2 & 5 \end{pmatrix}, \begin{pmatrix} 1 \\ -3 \end{pmatrix} \quad (b) \begin{pmatrix} 4 & -8 \\ 2 & -4 \end{pmatrix}, \begin{pmatrix} 0 \\ 1 \end{pmatrix} \quad (c) \begin{pmatrix} 1 & -1 & 1 \\ 1 & 1 & -1 \\ -1 & -1 & 1 \end{pmatrix}, \begin{pmatrix} 2 \\ 0 \\ 0 \end{pmatrix}$$

✓ 2.12 Decide if each vector lies in the range of the map from  $\mathbb{R}^3$  to  $\mathbb{R}^2$  represented with respect to the standard bases by the matrix.

$$(a) \begin{pmatrix} 1 & 1 & 3 \\ 0 & 1 & 4 \end{pmatrix}, \begin{pmatrix} 1 \\ 3 \end{pmatrix} \quad (b) \begin{pmatrix} 2 & 0 & 3 \\ 4 & 0 & 6 \end{pmatrix}, \begin{pmatrix} 1 \\ 1 \end{pmatrix}$$

✓ 2.13 Consider this matrix, representing a transformation of  $\mathbb{R}^2$ , and these bases for that space.

$$\frac{1}{2} \begin{pmatrix} 1 & 1 \\ -1 & 1 \end{pmatrix} \quad B = \left\langle \begin{pmatrix} 0 \\ 1 \end{pmatrix}, \begin{pmatrix} 1 \\ 0 \end{pmatrix} \right\rangle \quad D = \left\langle \begin{pmatrix} 1 \\ 1 \end{pmatrix}, \begin{pmatrix} 1 \\ -1 \end{pmatrix} \right\rangle$$

- (a) To what vector in the codomain is the first member of B mapped?
- (b) The second member?
- (c) Where is a general vector from the domain (a vector with components  $x$  and  $y$ ) mapped? That is, what transformation of  $\mathbb{R}^2$  is represented with respect to B, D by this matrix?

2.14 What transformation of  $F = \{a \cos \theta + b \sin \theta \mid a, b \in \mathbb{R}\}$  is represented with respect to  $B = \langle \cos \theta - \sin \theta, \sin \theta \rangle$  and  $D = \langle \cos \theta + \sin \theta, \cos \theta \rangle$  by this matrix?

$$\begin{pmatrix} 0 & 0 \\ 1 & 0 \end{pmatrix}$$

✓ 2.15 Decide whether  $1 + 2x$  is in the range of the map from  $\mathbb{R}^3$  to  $\mathcal{P}_2$  represented with respect to  $\mathcal{E}_3$  and  $\langle 1, 1 + x^2, x \rangle$  by this matrix.

$$\begin{pmatrix} 1 & 3 & 0 \\ 0 & 1 & 0 \\ 1 & 0 & 1 \end{pmatrix}$$

2.16 Example 2.10 gives a matrix that is nonsingular and is therefore associated with maps that are nonsingular.

- (a) Find the set of column vectors representing the members of the nullspace of any map represented by this matrix.
- (b) Find the nullity of any such map.
- (c) Find the set of column vectors representing the members of the rangespace of any map represented by this matrix.
- (d) Find the rank of any such map.
- (e) Check that rank plus nullity equals the dimension of the domain.

- ✓ 2.17 Because the rank of a matrix equals the rank of any map it represents, if one matrix represents two different maps  $H = \text{Rep}_{B,D}(h) = \text{Rep}_{\hat{B},\hat{D}}(\hat{h})$  (where  $h, \hat{h}: V \rightarrow W$ ) then the dimension of the rangespace of  $h$  equals the dimension of the rangespace of  $\hat{h}$ . Must these equal-dimensioned rangespaces actually be the same?
- ✓ 2.18 Let  $V$  be an  $n$ -dimensional space with bases  $B$  and  $D$ . Consider a map that sends, for  $\vec{v} \in V$ , the column vector representing  $\vec{v}$  with respect to  $B$  to the column vector representing  $\vec{v}$  with respect to  $D$ . Show that map is a linear transformation of  $\mathbb{R}^n$ .
- 2.19 Example 2.2 shows that changing the pair of bases can change the map that a matrix represents, even though the domain and codomain remain the same. Could the map ever not change? Is there a matrix  $H$ , vector spaces  $V$  and  $W$ , and associated pairs of bases  $B_1, D_1$  and  $B_2, D_2$  (with  $B_1 \neq B_2$  or  $D_1 \neq D_2$  or both) such that the map represented by  $H$  with respect to  $B_1, D_1$  equals the map represented by  $H$  with respect to  $B_2, D_2$ ?
- ✓ 2.20 A square matrix is a *diagonal* matrix if it is all zeroes except possibly for the entries on its upper-left to lower-right diagonal—its 1, 1 entry, its 2, 2 entry, etc. Show that a linear map is an isomorphism if there are bases such that, with respect to those bases, the map is represented by a diagonal matrix with no zeroes on the diagonal.
- 2.21 Describe geometrically the action on  $\mathbb{R}^2$  of the map represented with respect to the standard bases  $\mathcal{E}_1, \mathcal{E}_2$  by this matrix.

$$\begin{pmatrix} 3 & 0 \\ 0 & 2 \end{pmatrix}$$

Do the same for these.

$$\begin{pmatrix} 1 & 0 \\ 0 & 0 \end{pmatrix} \quad \begin{pmatrix} 0 & 1 \\ 1 & 0 \end{pmatrix} \quad \begin{pmatrix} 1 & 3 \\ 0 & 1 \end{pmatrix}$$

- 2.22 The fact that for any linear map the rank plus the nullity equals the dimension of the domain shows that a necessary condition for the existence of a homomorphism between two spaces, onto the second space, is that there be no gain in dimension. That is, where  $h: V \rightarrow W$  is onto, the dimension of  $W$  must be less than or equal to the dimension of  $V$ .

- (a) Show that this (strong) converse holds: no gain in dimension implies that there is a homomorphism and, further, any matrix with the correct size and correct rank represents such a map.
- (b) Are there bases for  $\mathbb{R}^3$  such that this matrix

$$H = \begin{pmatrix} 1 & 0 & 0 \\ 2 & 0 & 0 \\ 0 & 1 & 0 \end{pmatrix}$$

represents a map from  $\mathbb{R}^3$  to  $\mathbb{R}^3$  whose range is the  $xy$  plane subspace of  $\mathbb{R}^3$ ?

- 2.23 Let  $V$  be an  $n$ -dimensional space and suppose that  $\vec{x} \in \mathbb{R}^n$ . Fix a basis  $B$  for  $V$  and consider the map  $h_{\vec{x}}: V \rightarrow \mathbb{R}$  given  $\vec{v} \mapsto \vec{x} \cdot \text{Rep}_B(\vec{v})$  by the dot product.
- (a) Show that this map is linear.
- (b) Show that for any linear map  $g: V \rightarrow \mathbb{R}$  there is an  $\vec{x} \in \mathbb{R}^n$  such that  $g = h_{\vec{x}}$ .
- (c) In the prior item we fixed the basis and varied the  $\vec{x}$  to get all possible linear maps. Can we get all possible linear maps by fixing an  $\vec{x}$  and varying the basis?

2.24 Let  $V, W, X$  be vector spaces with bases  $B, C, D$ .

- (a) Suppose that  $h: V \rightarrow W$  is represented with respect to  $B, C$  by the matrix  $H$ . Give the matrix representing the scalar multiple  $rh$  (where  $r \in \mathbb{R}$ ) with respect to  $B, C$  by expressing it in terms of  $H$ .
- (b) Suppose that  $h, g: V \rightarrow W$  are represented with respect to  $B, C$  by  $H$  and  $G$ . Give the matrix representing  $h + g$  with respect to  $B, C$  by expressing it in terms of  $H$  and  $G$ .
- (c) Suppose that  $h: V \rightarrow W$  is represented with respect to  $B, C$  by  $H$  and  $g: W \rightarrow X$  is represented with respect to  $C, D$  by  $G$ . Give the matrix representing  $g \circ h$  with respect to  $B, D$  by expressing it in terms of  $H$  and  $G$ .

## IV Matrix Operations

The prior section shows how matrices represent linear maps. When we see a new idea, a good strategy is to explore how it interacts with some things that we already understand. In the first subsection below we will see how the representation of the sum of two maps  $f + g$  relates to the representations of  $f$  and  $g$ , and also how the representation of a scalar product  $r \cdot f$  relates to the representation of  $f$ . In the later subsections we will explore the representation of linear map composition and inverse.

### IV.1 Sums and Scalar Products

Recall that for two maps  $f, g: V \rightarrow W$ , the map sum  $f + g$  has this definition.

$$\vec{v} \xrightarrow{f+g} f(\vec{v}) + g(\vec{v})$$

To see how  $\text{Rep}_{B,D}(f + g)$  relates to  $\text{Rep}_{B,D}(f)$  and  $\text{Rep}_{B,D}(g)$  we consider an example.

**1.1 Example** Suppose that  $f, g: \mathbb{R}^2 \rightarrow \mathbb{R}^3$  are represented with respect to some bases  $B$  and  $D$  by these matrices.

$$F = \text{Rep}_{B,D}(f) = \begin{pmatrix} 1 & 3 \\ 2 & 0 \\ 1 & 0 \end{pmatrix}_{B,D} \quad G = \text{Rep}_{B,D}(g) = \begin{pmatrix} 0 & 0 \\ -1 & -2 \\ 2 & 4 \end{pmatrix}_{B,D}$$

Let  $\vec{v} \in V$  be represented with respect to  $B$ . We compute the representation of  $f(\vec{v})$  and of  $g(\vec{v})$  and add them.

$$\begin{pmatrix} 1 & 3 \\ 2 & 0 \\ 1 & 0 \end{pmatrix} \begin{pmatrix} v_1 \\ v_2 \end{pmatrix} + \begin{pmatrix} 0 & 0 \\ -1 & -2 \\ 2 & 4 \end{pmatrix} \begin{pmatrix} v_1 \\ v_2 \end{pmatrix} = \begin{pmatrix} 1v_1 + 3v_2 \\ 2v_1 + 0v_2 \\ 1v_1 + 0v_2 \end{pmatrix} + \begin{pmatrix} 0v_1 + 0v_2 \\ -1v_1 - 2v_2 \\ 2v_1 + 4v_2 \end{pmatrix}$$

So this is the representation of  $f + g(\vec{v})$ .

$$\begin{pmatrix} (1+0)v_1 + (3+0)v_2 \\ (2-1)v_1 + (0-2)v_2 \\ (1+2)v_1 + (0+4)v_2 \end{pmatrix} = \begin{pmatrix} 1v_1 + 3v_2 \\ 1v_1 - 2v_2 \\ 3v_1 + 4v_2 \end{pmatrix}$$

Thus, this matrix-vector product describes the action of  $f + g$ .

$$\begin{pmatrix} 1 & 3 \\ 1 & -2 \\ 3 & 4 \end{pmatrix}_{B,D} \begin{pmatrix} v_1 \\ v_2 \end{pmatrix}_B = \begin{pmatrix} 1v_1 + 3v_2 \\ 1v_1 - 2v_2 \\ 3v_1 + 4v_2 \end{pmatrix}_D$$

So the matrix is  $\text{Rep}_{B,D}(f + g)$ . This matrix is the entry-by-entry sum of original matrices.

We can see how scalar multiplication affects the representation with a similar example.

**1.2 Example** Suppose that  $t$  is a transformation represented by this matrix

$$\text{Rep}_{B,D}(t) = \begin{pmatrix} 1 & 0 \\ 1 & 1 \end{pmatrix}_{B,D}$$

so that this is the action of  $t$ .

$$\vec{v} = \begin{pmatrix} v_1 \\ v_2 \end{pmatrix}_B \mapsto \begin{pmatrix} v_1 \\ v_1 + v_2 \end{pmatrix}_D = t(\vec{v})$$

Then the scalar multiple map  $5t$  is

$$\vec{v} = \begin{pmatrix} v_1 \\ v_2 \end{pmatrix}_B \mapsto \begin{pmatrix} 5v_1 \\ 5v_1 + 5v_2 \end{pmatrix}_D = 5 \cdot t(\vec{v})$$

and so this is the matrix representing  $5t$ .

$$\text{Rep}_{B,D}(5t) = \begin{pmatrix} 5 & 0 \\ 5 & 5 \end{pmatrix}_{B,D}$$

**1.3 Definition** The *sum* of two same-sized matrices is their entry-by-entry sum. The *scalar multiple* of a matrix is the result of entry-by-entry scalar multiplication.

These operations extend the vector addition and scalar multiplication operations that we defined in the first chapter.

**1.4 Theorem** Let  $h, g: V \rightarrow W$  be linear maps represented with respect to bases  $B, D$  by the matrices  $H$  and  $G$ , and let  $r$  be a scalar. Then the map  $h + g: V \rightarrow W$  is represented with respect to  $B, D$  by  $H + G$ , and the map  $r \cdot h: V \rightarrow W$  is represented with respect to  $B, D$  by  $rH$ .

**PROOF** Exercise 9; generalize the examples above.

QED

**1.5 Remark** Recall Remark III.1.6 following Theorem III.1.4. That theorem says that matrix-vector multiplication represents the application of a linear map and the remark notes that the theorem simply justifies the definition of matrix-vector multiplication. In some sense the theorem has to hold, because if it didn't then we would adjust the definition to make the theorem hold. The above theorem is another example of such a result; it shows that our definition of the operations is sensible.

A special case of scalar multiplication is multiplication by zero. For any map  $0 \cdot h$  is the zero homomorphism and for any matrix  $0 \cdot H$  is the matrix with all entries zero.

**1.6 Definition** A *zero matrix* has all entries 0. We write  $Z_{n \times m}$  or simply  $Z$  (another common notation is to use  $0_{n \times m}$  or just 0).

**1.7 Example** The zero map from any three-dimensional space to any two-dimensional space is represented by the  $2 \times 3$  zero matrix

$$Z = \begin{pmatrix} 0 & 0 & 0 \\ 0 & 0 & 0 \end{pmatrix}$$

no matter what domain and codomain bases we use.

### Exercises

✓ **1.8** Perform the indicated operations, if defined.

(a)  $\begin{pmatrix} 5 & -1 & 2 \\ 6 & 1 & 1 \end{pmatrix} + \begin{pmatrix} 2 & 1 & 4 \\ 3 & 0 & 5 \end{pmatrix}$

(b)  $6 \cdot \begin{pmatrix} 2 & -1 & -1 \\ 1 & 2 & 3 \end{pmatrix}$

(c)  $\begin{pmatrix} 2 & 1 \\ 0 & 3 \end{pmatrix} + \begin{pmatrix} 2 & 1 \\ 0 & 3 \end{pmatrix}$

(d)  $4 \begin{pmatrix} 1 & 2 \\ 3 & -1 \end{pmatrix} + 5 \begin{pmatrix} -1 & 4 \\ -2 & 1 \end{pmatrix}$

(e)  $3 \begin{pmatrix} 2 & 1 \\ 3 & 0 \end{pmatrix} + 2 \begin{pmatrix} 1 & 1 & 4 \\ 3 & 0 & 5 \end{pmatrix}$

**1.9** Prove Theorem 1.4.

(a) Prove that matrix addition represents addition of linear maps.

(b) Prove that matrix scalar multiplication represents scalar multiplication of linear maps.

✓ **1.10** Prove each, assuming that the operations are defined, where  $G$ ,  $H$ , and  $J$  are matrices, where  $Z$  is the zero matrix, and where  $r$  and  $s$  are scalars.

(a) Matrix addition is commutative  $G + H = H + G$ .

(b) Matrix addition is associative  $G + (H + J) = (G + H) + J$ .

(c) The zero matrix is an additive identity  $G + Z = G$ .

(d)  $0 \cdot G = Z$

(e)  $(r + s)G = rG + sG$

(f) Matrices have an additive inverse  $G + (-1) \cdot G = Z$ .

(g)  $r(G + H) = rG + rH$

(h)  $(rs)G = r(sG)$

**1.11** Fix domain and codomain spaces. In general, one matrix can represent many different maps with respect to different bases. However, prove that a zero matrix represents only a zero map. Are there other such matrices?

✓ **1.12** Let  $V$  and  $W$  be vector spaces of dimensions  $n$  and  $m$ . Show that the space  $\mathcal{L}(V, W)$  of linear maps from  $V$  to  $W$  is isomorphic to  $\mathcal{M}_{m \times n}$ .

✓ **1.13** Show that it follows from the prior questions that for any six transformations  $t_1, \dots, t_6: \mathbb{R}^2 \rightarrow \mathbb{R}^2$  there are scalars  $c_1, \dots, c_6 \in \mathbb{R}$  such that  $c_1 t_1 + \dots + c_6 t_6$  is the zero map. (*Hint*: this is a bit of a misleading question.)

**1.14** The *trace* of a square matrix is the sum of the entries on the main diagonal (the 1,1 entry plus the 2,2 entry, etc.; we will see the significance of the trace in Chapter Five). Show that  $\text{trace}(H + G) = \text{trace}(H) + \text{trace}(G)$ . Is there a similar result for scalar multiplication?



- 1.15 Recall that the *transpose* of a matrix  $M$  is another matrix, whose  $i, j$  entry is the  $j, i$  entry of  $M$ . Verify these identities.
- (a)  $(G + H)^{\text{trans}} = G^{\text{trans}} + H^{\text{trans}}$
  - (b)  $(r \cdot H)^{\text{trans}} = r \cdot H^{\text{trans}}$
- ✓ 1.16 A square matrix is *symmetric* if each  $i, j$  entry equals the  $j, i$  entry, that is, if the matrix equals its transpose.
- (a) Prove that for any  $H$ , the matrix  $H + H^{\text{trans}}$  is symmetric. Does every symmetric matrix have this form?
  - (b) Prove that the set of  $n \times n$  symmetric matrices is a subspace of  $\mathcal{M}_{n \times n}$ .
- ✓ 1.17 (a) How does matrix rank interact with scalar multiplication—can a scalar product of a rank  $n$  matrix have rank less than  $n$ ? Greater?
- (b) How does matrix rank interact with matrix addition—can a sum of rank  $n$  matrices have rank less than  $n$ ? Greater?

## IV.2 Matrix Multiplication

After representing addition and scalar multiplication of linear maps in the prior subsection, the natural next map operation to consider is composition.

**2.1 Lemma** A composition of linear maps is linear.

PROOF (*This argument has appeared earlier, as part of the proof of Theorem I.2.2.*) Let  $h: V \rightarrow W$  and  $g: W \rightarrow U$  be linear. The calculation

$$\begin{aligned} g \circ h(c_1 \cdot \vec{v}_1 + c_2 \cdot \vec{v}_2) &= g(h(c_1 \cdot \vec{v}_1 + c_2 \cdot \vec{v}_2)) = g(c_1 \cdot h(\vec{v}_1) + c_2 \cdot h(\vec{v}_2)) \\ &= c_1 \cdot g(h(\vec{v}_1)) + c_2 \cdot g(h(\vec{v}_2)) = c_1 \cdot (g \circ h)(\vec{v}_1) + c_2 \cdot (g \circ h)(\vec{v}_2) \end{aligned}$$

shows that  $g \circ h: V \rightarrow U$  preserves linear combinations. QED

To see how the representation of the composite relates to the representations of the compositors, consider an example.

**2.2 Example** Let  $h: \mathbb{R}^4 \rightarrow \mathbb{R}^2$  and  $g: \mathbb{R}^2 \rightarrow \mathbb{R}^3$ , fix bases  $B \subset \mathbb{R}^4$ ,  $C \subset \mathbb{R}^2$ ,  $D \subset \mathbb{R}^3$ , and let these be the representations.

$$H = \text{Rep}_{B,C}(h) = \begin{pmatrix} 4 & 6 & 8 & 2 \\ 5 & 7 & 9 & 3 \end{pmatrix}_{B,C} \quad G = \text{Rep}_{C,D}(g) = \begin{pmatrix} 1 & 1 \\ 0 & 1 \\ 1 & 0 \end{pmatrix}_{C,D}$$

To represent the composition  $g \circ h: \mathbb{R}^4 \rightarrow \mathbb{R}^3$  we start with a  $\vec{v}$ , represent  $h$  of  $\vec{v}$ , and then represent  $g$  of that. The representation of  $h(\vec{v})$  is the product of  $h$ 's matrix and  $\vec{v}$ 's vector.

$$\text{Rep}_C(h(\vec{v})) = \begin{pmatrix} 4 & 6 & 8 & 2 \\ 5 & 7 & 9 & 3 \end{pmatrix}_{B,C} \begin{pmatrix} v_1 \\ v_2 \\ v_3 \\ v_4 \end{pmatrix}_B = \begin{pmatrix} 4v_1 + 6v_2 + 8v_3 + 2v_4 \\ 5v_1 + 7v_2 + 9v_3 + 3v_4 \end{pmatrix}_C$$

The representation of  $g(h(\vec{v}))$  is the product of  $g$ 's matrix and  $h(\vec{v})$ 's vector.

$$\begin{aligned} \text{Rep}_D(g(h(\vec{v}))) &= \begin{pmatrix} 1 & 1 \\ 0 & 1 \\ 1 & 0 \end{pmatrix}_{C,D} \begin{pmatrix} 4v_1 + 6v_2 + 8v_3 + 2v_4 \\ 5v_1 + 7v_2 + 9v_3 + 3v_4 \end{pmatrix}_C \\ &= \begin{pmatrix} 1 \cdot (4v_1 + 6v_2 + 8v_3 + 2v_4) + 1 \cdot (5v_1 + 7v_2 + 9v_3 + 3v_4) \\ 0 \cdot (4v_1 + 6v_2 + 8v_3 + 2v_4) + 1 \cdot (5v_1 + 7v_2 + 9v_3 + 3v_4) \\ 1 \cdot (4v_1 + 6v_2 + 8v_3 + 2v_4) + 0 \cdot (5v_1 + 7v_2 + 9v_3 + 3v_4) \end{pmatrix}_D \end{aligned}$$

Distributing and regrouping on the  $v$ 's gives

$$= \begin{pmatrix} (1 \cdot 4 + 1 \cdot 5)v_1 + (1 \cdot 6 + 1 \cdot 7)v_2 + (1 \cdot 8 + 1 \cdot 9)v_3 + (1 \cdot 2 + 1 \cdot 3)v_4 \\ (0 \cdot 4 + 1 \cdot 5)v_1 + (0 \cdot 6 + 1 \cdot 7)v_2 + (0 \cdot 8 + 1 \cdot 9)v_3 + (0 \cdot 2 + 1 \cdot 3)v_4 \\ (1 \cdot 4 + 0 \cdot 5)v_1 + (1 \cdot 6 + 0 \cdot 7)v_2 + (1 \cdot 8 + 0 \cdot 9)v_3 + (1 \cdot 2 + 0 \cdot 3)v_4 \end{pmatrix}_D$$

which we recognize as the result of this matrix-vector product.

$$= \begin{pmatrix} 1 \cdot 4 + 1 \cdot 5 & 1 \cdot 6 + 1 \cdot 7 & 1 \cdot 8 + 1 \cdot 9 & 1 \cdot 2 + 1 \cdot 3 \\ 0 \cdot 4 + 1 \cdot 5 & 0 \cdot 6 + 1 \cdot 7 & 0 \cdot 8 + 1 \cdot 9 & 0 \cdot 2 + 1 \cdot 3 \\ 1 \cdot 4 + 0 \cdot 5 & 1 \cdot 6 + 0 \cdot 7 & 1 \cdot 8 + 0 \cdot 9 & 1 \cdot 2 + 0 \cdot 3 \end{pmatrix}_{B,D} \begin{pmatrix} v_1 \\ v_2 \\ v_3 \\ v_4 \end{pmatrix}_D$$

Thus the matrix representing  $g \circ h$  has the rows of  $G$  combined with the columns of  $H$ .

**2.3 Definition** The *matrix-multiplicative product* of the  $m \times r$  matrix  $G$  and the  $r \times n$  matrix  $H$  is the  $m \times n$  matrix  $P$ , where

$$p_{i,j} = g_{i,1}h_{1,j} + g_{i,2}h_{2,j} + \cdots + g_{i,r}h_{r,j}$$

that is, the  $i, j$ -th entry of the product is the dot product of the  $i$ -th row of the first matrix with the  $j$ -th column of the second.

$$GH = \begin{pmatrix} & \vdots & & \\ g_{i,1} & g_{i,2} & \cdots & g_{i,r} \\ & \vdots & & \end{pmatrix} \begin{pmatrix} & h_{1,j} & & \\ \cdots & h_{2,j} & \cdots & \\ & \vdots & & \\ & h_{r,j} & & \end{pmatrix} = \begin{pmatrix} & \vdots & & \\ \cdots & p_{i,j} & \cdots & \\ & \vdots & & \end{pmatrix}$$

**2.4 Example** The matrices from Example 2.2 combine in this way.

$$\begin{pmatrix} 1 \cdot 4 + 1 \cdot 5 & 1 \cdot 6 + 1 \cdot 7 & 1 \cdot 8 + 1 \cdot 9 & 1 \cdot 2 + 1 \cdot 3 \\ 0 \cdot 4 + 1 \cdot 5 & 0 \cdot 6 + 1 \cdot 7 & 0 \cdot 8 + 1 \cdot 9 & 0 \cdot 2 + 1 \cdot 3 \\ 1 \cdot 4 + 0 \cdot 5 & 1 \cdot 6 + 0 \cdot 7 & 1 \cdot 8 + 0 \cdot 9 & 1 \cdot 2 + 0 \cdot 3 \end{pmatrix} = \begin{pmatrix} 9 & 13 & 17 & 5 \\ 5 & 7 & 9 & 3 \\ 4 & 6 & 8 & 2 \end{pmatrix}$$

**2.5 Example**

$$\begin{pmatrix} 2 & 0 \\ 4 & 6 \\ 8 & 2 \end{pmatrix} \begin{pmatrix} 1 & 3 \\ 5 & 7 \end{pmatrix} = \begin{pmatrix} 2 \cdot 1 + 0 \cdot 5 & 2 \cdot 3 + 0 \cdot 7 \\ 4 \cdot 1 + 6 \cdot 5 & 4 \cdot 3 + 6 \cdot 7 \\ 8 \cdot 1 + 2 \cdot 5 & 8 \cdot 3 + 2 \cdot 7 \end{pmatrix} = \begin{pmatrix} 2 & 6 \\ 34 & 54 \\ 18 & 38 \end{pmatrix}$$

We next check that our definition of the matrix-matrix multiplication operation does what we intend.

**2.6 Theorem** A composition of linear maps is represented by the matrix product of the representatives.

**PROOF** This argument generalizes Example 2.2. Let  $h: V \rightarrow W$  and  $g: W \rightarrow X$  be represented by  $H$  and  $G$  with respect to bases  $B \subset V$ ,  $C \subset W$ , and  $D \subset X$ , of sizes  $n$ ,  $r$ , and  $m$ . For any  $\vec{v} \in V$ , the  $k$ -th component of  $\text{Rep}_C(h(\vec{v}))$  is

$$h_{k,1}v_1 + \cdots + h_{k,n}v_n$$

and so the  $i$ -th component of  $\text{Rep}_D(g \circ h(\vec{v}))$  is this.

$$g_{i,1} \cdot (h_{1,1}v_1 + \cdots + h_{1,n}v_n) + g_{i,2} \cdot (h_{2,1}v_1 + \cdots + h_{2,n}v_n) \\ + \cdots + g_{i,r} \cdot (h_{r,1}v_1 + \cdots + h_{r,n}v_n)$$

Distribute and regroup on the  $v$ 's.

$$= (g_{i,1}h_{1,1} + g_{i,2}h_{2,1} + \cdots + g_{i,r}h_{r,1}) \cdot v_1 \\ + \cdots + (g_{i,1}h_{1,n} + g_{i,2}h_{2,n} + \cdots + g_{i,r}h_{r,n}) \cdot v_n$$

Finish by recognizing that the coefficient of each  $v_j$

$$g_{i,1}h_{1,j} + g_{i,2}h_{2,j} + \cdots + g_{i,r}h_{r,j}$$

matches the definition of the  $i, j$  entry of the product  $GH$ . QED

This *arrow diagram* pictures the relationship between maps and matrices ('wrt' abbreviates 'with respect to').

$$\begin{array}{ccc} & W_{\text{wrt } C} & \\ & \nearrow h & \searrow g \\ & H & G \\ V_{\text{wrt } B} & \xrightarrow{g \circ h} & X_{\text{wrt } D} \\ & GH & \end{array}$$

Above the arrows, the maps show that the two ways of going from  $V$  to  $X$ , straight over via the composition or else in two steps by way of  $W$ , have the same effect

$$\vec{v} \xrightarrow{g \circ h} g(h(\vec{v})) \quad \vec{v} \xrightarrow{h} h(\vec{v}) \xrightarrow{g} g(h(\vec{v}))$$

(this is just the definition of composition). Below the arrows, the matrices indicate that the product does the same thing — multiplying  $GH$  into the column vector  $\text{Rep}_B(\vec{v})$  has the same effect as multiplying the column vector first by  $H$  and then multiplying the result by  $G$ .

$$\text{Rep}_{B,D}(g \circ h) = GH \quad \text{Rep}_{C,D}(g) \text{Rep}_{B,C}(h) = GH$$

**2.7 Example** Because the number of columns on the left does not equal the number of rows on the right, this product is not defined.

$$\begin{pmatrix} -1 & 2 & 0 \\ 0 & 10 & 1.1 \end{pmatrix} \begin{pmatrix} 0 & 0 \\ 0 & 2 \end{pmatrix}$$

One way to understand why the combination in the prior example is undefined has to do with the underlying maps. We require that the sizes match because we want that the underlying function composition is possible.

$$\text{dimension } n \text{ space} \xrightarrow{h} \text{dimension } r \text{ space} \xrightarrow{g} \text{dimension } m \text{ space}$$

So matrix product has a  $m \times r$  matrix  $G$  times a  $r \times n$  matrix  $F$  to get a  $m \times n$  result  $GF$ . Briefly, ‘ $m \times r$  times  $r \times n$  equals  $m \times n$ ’.

**2.8 Remark** The order in which these things are written can be confusing. In the prior equation, the number written first  $m$  is the dimension of  $g$ ’s codomain and is thus the number that appears last in the map dimension description above. The explanation is that while  $h$  is done first and then  $g$ , we write the composition as  $g \circ h$ , from the notation ‘ $g(h(\vec{v}))$ ’. (Some people try to lessen confusion by reading ‘ $g \circ h$ ’ aloud as “ $g$  following  $h$ .”) That right to left order carries over to matrices:  $g \circ h$  is represented by  $GH$ .

We can get insight into matrix-matrix product operation by studying how the entries combine. For instance, an alternative way to understand why we require above that the sizes match is that the row of the left-hand matrix must have the same number of entries as the column of the right-hand matrix, or else some entry will be left without a matching entry from the other matrix.

Another aspect of the combinatorics of matrix multiplication is that in the definition of the  $i, j$  entry

$$p_{i,j} = g_{i, \mathbf{1}} h_{\mathbf{1},j} + g_{i, \mathbf{2}} h_{\mathbf{2},j} + \cdots + g_{i, \mathbf{r}} h_{\mathbf{r},j}$$

the highlighted subscripts on the  $g$ ’s are column indices while those on the  $h$ ’s indicate rows. That is, the summation takes place over the columns of  $G$  but over the rows of  $H$ —the definition treats left differently than right. So we may reasonably suspect that  $GH$  can be unequal to  $HG$ .

**2.9 Example** Matrix multiplication is not commutative.

$$\begin{pmatrix} 1 & 2 \\ 3 & 4 \end{pmatrix} \begin{pmatrix} 5 & 6 \\ 7 & 8 \end{pmatrix} = \begin{pmatrix} 19 & 22 \\ 43 & 50 \end{pmatrix} \quad \begin{pmatrix} 5 & 6 \\ 7 & 8 \end{pmatrix} \begin{pmatrix} 1 & 2 \\ 3 & 4 \end{pmatrix} = \begin{pmatrix} 23 & 34 \\ 31 & 46 \end{pmatrix}$$

**2.10 Example** Commutativity can fail more dramatically:

$$\begin{pmatrix} 5 & 6 \\ 7 & 8 \end{pmatrix} \begin{pmatrix} 1 & 2 & 0 \\ 3 & 4 & 0 \end{pmatrix} = \begin{pmatrix} 23 & 34 & 0 \\ 31 & 46 & 0 \end{pmatrix}$$

while

$$\begin{pmatrix} 1 & 2 & 0 \\ 3 & 4 & 0 \end{pmatrix} \begin{pmatrix} 5 & 6 \\ 7 & 8 \end{pmatrix}$$

isn’t even defined.

**2.11 Remark** The fact that matrix multiplication is not commutative can be puzzling at first, perhaps because most operations in elementary mathematics are commutative. But matrix multiplication represents function composition, which is not commutative: if  $f(x) = 2x$  and  $g(x) = x + 1$  then  $g \circ f(x) = 2x + 1$  while  $f \circ g(x) = 2(x + 1) = 2x + 2$ . (True, this  $g$  is not linear and we might have hoped that linear functions would commute but this shows that the failure of commutativity for matrix multiplication fits into a larger context.)

Except for the lack of commutativity, matrix multiplication is algebraically well-behaved. Below are some nice properties and more are in Exercise 24 and Exercise 25.

**2.12 Theorem** If  $F$ ,  $G$ , and  $H$  are matrices, and the matrix products are defined, then the product is associative  $(FG)H = F(GH)$  and distributes over matrix addition  $F(G + H) = FG + FH$  and  $(G + H)F = GF + HF$ .

**PROOF** Associativity holds because matrix multiplication represents function composition, which is associative: the maps  $(f \circ g) \circ h$  and  $f \circ (g \circ h)$  are equal as both send  $\vec{v}$  to  $f(g(h(\vec{v})))$ .

Distributivity is similar. For instance, the first one goes  $f \circ (g + h)(\vec{v}) = f((g + h)(\vec{v})) = f(g(\vec{v}) + h(\vec{v})) = f(g(\vec{v})) + f(h(\vec{v})) = f \circ g(\vec{v}) + f \circ h(\vec{v})$  (the third equality uses the linearity of  $f$ ). QED

**2.13 Remark** We could instead prove that result by slogging through the indices. For example, for associativity the  $i, j$ -th entry of  $(FG)H$  is

$$\begin{aligned} & (f_{i,1}g_{1,1} + f_{i,2}g_{2,1} + \cdots + f_{i,r}g_{r,1})h_{1,j} \\ & + (f_{i,1}g_{1,2} + f_{i,2}g_{2,2} + \cdots + f_{i,r}g_{r,2})h_{2,j} \\ & \vdots \\ & + (f_{i,1}g_{1,s} + f_{i,2}g_{2,s} + \cdots + f_{i,r}g_{r,s})h_{s,j} \end{aligned}$$

(where  $F$ ,  $G$ , and  $H$  are  $m \times r$ ,  $r \times s$ , and  $s \times n$  matrices), distribute

$$\begin{aligned} & f_{i,1}g_{1,1}h_{1,j} + f_{i,2}g_{2,1}h_{1,j} + \cdots + f_{i,r}g_{r,1}h_{1,j} \\ & + f_{i,1}g_{1,2}h_{2,j} + f_{i,2}g_{2,2}h_{2,j} + \cdots + f_{i,r}g_{r,2}h_{2,j} \\ & \vdots \\ & + f_{i,1}g_{1,s}h_{s,j} + f_{i,2}g_{2,s}h_{s,j} + \cdots + f_{i,r}g_{r,s}h_{s,j} \end{aligned}$$

and regroup around the  $f$ 's

$$\begin{aligned} & f_{i,1}(g_{1,1}h_{1,j} + g_{1,2}h_{2,j} + \cdots + g_{1,s}h_{s,j}) \\ & + f_{i,2}(g_{2,1}h_{1,j} + g_{2,2}h_{2,j} + \cdots + g_{2,s}h_{s,j}) \\ & \vdots \\ & + f_{i,r}(g_{r,1}h_{1,j} + g_{r,2}h_{2,j} + \cdots + g_{r,s}h_{s,j}) \end{aligned}$$

to get the  $i, j$  entry of  $F(GH)$ .

Contrast the two ways of verifying associativity. The argument just above is hard to understand in that while the calculations are easy to check, the arithmetic seems unconnected to any idea. The argument in the proof is shorter and says why this property “really” holds. This illustrates the comments made at the start of the chapter on vector spaces — at least some of the time an argument from higher-level constructs is clearer.

We have now seen how to construct the representation of the composition of two linear maps from the representations of the two maps. We have called the combination the product of the two matrices. We will explore this operation more in the next subsection.

### Exercises

✓ **2.14** Compute, or state “not defined”.

$$\begin{array}{ll} \text{(a)} \begin{pmatrix} 3 & 1 \\ -4 & 2 \end{pmatrix} \begin{pmatrix} 0 & 5 \\ 0 & 0.5 \end{pmatrix} & \text{(b)} \begin{pmatrix} 1 & 1 & -1 \\ 4 & 0 & 3 \end{pmatrix} \begin{pmatrix} 2 & -1 & -1 \\ 3 & 1 & 1 \\ 3 & 1 & 1 \end{pmatrix} \\ \text{(c)} \begin{pmatrix} 2 & -7 \\ 7 & 4 \end{pmatrix} \begin{pmatrix} 1 & 0 & 5 \\ -1 & 1 & 1 \\ 3 & 8 & 4 \end{pmatrix} & \text{(d)} \begin{pmatrix} 5 & 2 \\ 3 & 1 \end{pmatrix} \begin{pmatrix} -1 & 2 \\ 3 & -5 \end{pmatrix} \end{array}$$

✓ **2.15** Where

$$A = \begin{pmatrix} 1 & -1 \\ 2 & 0 \end{pmatrix} \quad B = \begin{pmatrix} 5 & 2 \\ 4 & 4 \end{pmatrix} \quad C = \begin{pmatrix} -2 & 3 \\ -4 & 1 \end{pmatrix}$$

compute or state ‘not defined’.

$$\text{(a)} AB \quad \text{(b)} (AB)C \quad \text{(c)} BC \quad \text{(d)} A(BC)$$

**2.16** Which products are defined?

$$\begin{array}{lll} \text{(a)} 3 \times 2 \text{ times } 2 \times 3 & \text{(b)} 2 \times 3 \text{ times } 3 \times 2 & \text{(c)} 2 \times 2 \text{ times } 3 \times 3 \\ \text{(d)} 3 \times 3 \text{ times } 2 \times 2 & & \end{array}$$

✓ **2.17** Give the size of the product or state “not defined”.

- (a) a  $2 \times 3$  matrix times a  $3 \times 1$  matrix
- (b) a  $1 \times 12$  matrix times a  $12 \times 1$  matrix
- (c) a  $2 \times 3$  matrix times a  $2 \times 1$  matrix
- (d) a  $2 \times 2$  matrix times a  $2 \times 2$  matrix

✓ **2.18** Find the system of equations resulting from starting with

$$\begin{array}{l} h_{1,1}x_1 + h_{1,2}x_2 + h_{1,3}x_3 = d_1 \\ h_{2,1}x_1 + h_{2,2}x_2 + h_{2,3}x_3 = d_2 \end{array}$$

and making this change of variable (i.e., substitution).

$$\begin{array}{l} x_1 = g_{1,1}y_1 + g_{1,2}y_2 \\ x_2 = g_{2,1}y_1 + g_{2,2}y_2 \\ x_3 = g_{3,1}y_1 + g_{3,2}y_2 \end{array}$$

**2.19** As Definition 2.3 points out, the matrix product operation generalizes the dot product. Is the dot product of a  $1 \times n$  row vector and a  $n \times 1$  column vector the same as their matrix-multiplicative product?

✓ **2.20** Represent the derivative map on  $\mathcal{P}_n$  with respect to  $B, B$  where  $B$  is the natural basis  $\langle 1, x, \dots, x^n \rangle$ . Show that the product of this matrix with itself is defined; what the map does it represent?

- 2.21 [Cleary] Match each type of matrix with all these descriptions that could fit: (i) can be multiplied by its transpose to make a  $1 \times 1$  matrix, (ii) is similar to the  $3 \times 3$  matrix of all zeros, (iii) can represent a linear map from  $\mathbb{R}^3$  to  $\mathbb{R}^2$  that is not onto, (iv) can represent an isomorphism from  $\mathbb{R}^3$  to  $\mathcal{P}^2$ .
- a  $2 \times 3$  matrix whose rank is 1
  - a  $3 \times 3$  matrix that is nonsingular
  - a  $2 \times 2$  matrix that is singular
  - an  $n \times 1$  column vector
- 2.22 Show that composition of linear transformations on  $\mathbb{R}^1$  is commutative. Is this true for any one-dimensional space?
- 2.23 Why is matrix multiplication not defined as entry-wise multiplication? That would be easier, and commutative too.
- ✓ 2.24 (a) Prove that  $H^p H^q = H^{p+q}$  and  $(H^p)^q = H^{pq}$  for positive integers  $p, q$ .  
 (b) Prove that  $(rH)^p = r^p \cdot H^p$  for any positive integer  $p$  and scalar  $r \in \mathbb{R}$ .
- ✓ 2.25 (a) How does matrix multiplication interact with scalar multiplication: is  $r(GH) = (rG)H$ ? Is  $G(rH) = r(GH)$ ?  
 (b) How does matrix multiplication interact with linear combinations: is  $F(rG + sH) = r(FG) + s(FH)$ ? Is  $(rF + sH)G = rFG + sHG$ ?
- 2.26 We can ask how the matrix product operation interacts with the transpose operation.
- Show that  $(GH)^{\text{trans}} = H^{\text{trans}} G^{\text{trans}}$ .
  - A square matrix is *symmetric* if each  $i, j$  entry equals the  $j, i$  entry, that is, if the matrix equals its own transpose. Show that the matrices  $HH^{\text{trans}}$  and  $H^{\text{trans}}H$  are symmetric.
- ✓ 2.27 Rotation of vectors in  $\mathbb{R}^3$  about an axis is a linear map. Show that linear maps do not commute by showing geometrically that rotations do not commute.
- 2.28 In the proof of Theorem 2.12 we used some maps. What are the domains and codomains?
- 2.29 How does matrix rank interact with matrix multiplication?
- Can the product of rank  $n$  matrices have rank less than  $n$ ? Greater?
  - Show that the rank of the product of two matrices is less than or equal to the minimum of the rank of each factor.
- 2.30 Is ‘commutes with’ an equivalence relation among  $n \times n$  matrices?
- ✓ 2.31 (We will use this exercise in the *Matrix Inverses exercises*.) Here is another property of matrix multiplication that might be puzzling at first sight.
- Prove that the composition of the projections  $\pi_x, \pi_y: \mathbb{R}^3 \rightarrow \mathbb{R}^3$  onto the  $x$  and  $y$  axes is the zero map despite that neither one is itself the zero map.
  - Prove that the composition of the derivatives  $d^2/dx^2, d^3/dx^3: \mathcal{P}_4 \rightarrow \mathcal{P}_4$  is the zero map despite that neither is the zero map.
  - Give a matrix equation representing the first fact.
  - Give a matrix equation representing the second.
- When two things multiply to give zero despite that neither is zero we say that each is a *zero divisor*.
- 2.32 Show that, for square matrices,  $(S + T)(S - T)$  need not equal  $S^2 - T^2$ .
- ✓ 2.33 Represent the identity transformation  $\text{id}: V \rightarrow V$  with respect to  $B, B$  for any basis  $B$ . This is the *identity matrix*  $I$ . Show that this matrix plays the role in matrix multiplication that the number 1 plays in real number multiplication:  $HI = IH = H$  (for all matrices  $H$  for which the product is defined).

- 2.34 In real number algebra, quadratic equations have at most two solutions. That is not so with matrix algebra. Show that the  $2 \times 2$  matrix equation  $T^2 = I$  has more than two solutions, where  $I$  is the identity matrix (this matrix has ones in its 1, 1 and 2, 2 entries and zeroes elsewhere; see Exercise 33).
- 2.35 (a) Prove that for any  $2 \times 2$  matrix  $T$  there are scalars  $c_0, \dots, c_4$  that are not all 0 such that the combination  $c_4 T^4 + c_3 T^3 + c_2 T^2 + c_1 T + c_0 I$  is the zero matrix (where  $I$  is the  $2 \times 2$  identity matrix, with 1's in its 1, 1 and 2, 2 entries and zeroes elsewhere; see Exercise 33).
- (b) Let  $p(x)$  be a polynomial  $p(x) = c_n x^n + \dots + c_1 x + c_0$ . If  $T$  is a square matrix we define  $p(T)$  to be the matrix  $c_n T^n + \dots + c_1 T + I$  (where  $I$  is the appropriately-sized identity matrix). Prove that for any square matrix there is a polynomial such that  $p(T)$  is the zero matrix.
- (c) The *minimal polynomial*  $m(x)$  of a square matrix is the polynomial of least degree, and with leading coefficient 1, such that  $m(T)$  is the zero matrix. Find the minimal polynomial of this matrix.

$$\begin{pmatrix} \sqrt{3}/2 & -1/2 \\ 1/2 & \sqrt{3}/2 \end{pmatrix}$$

(This is the representation with respect to  $\mathcal{E}_2, \mathcal{E}_2$ , the standard basis, of a rotation through  $\pi/6$  radians counterclockwise.)

- 2.36 The infinite-dimensional space  $\mathcal{P}$  of all finite-degree polynomials gives a memorable example of the non-commutativity of linear maps. Let  $d/dx: \mathcal{P} \rightarrow \mathcal{P}$  be the usual derivative and let  $s: \mathcal{P} \rightarrow \mathcal{P}$  be the *shift* map.

$$a_0 + a_1 x + \dots + a_n x^n \xrightarrow{s} 0 + a_0 x + a_1 x^2 + \dots + a_n x^{n+1}$$

Show that the two maps don't commute  $d/dx \circ s \neq s \circ d/dx$ ; in fact, not only is  $(d/dx \circ s) - (s \circ d/dx)$  not the zero map, it is the identity map.

- 2.37 Recall the notation for the sum of the sequence of numbers  $a_1, a_2, \dots, a_n$ .

$$\sum_{i=1}^n a_i = a_1 + a_2 + \dots + a_n$$

In this notation, the  $i, j$  entry of the product of  $G$  and  $H$  is this.

$$p_{i,j} = \sum_{k=1}^r g_{i,k} h_{k,j}$$

Using this notation,

- (a) reprove that matrix multiplication is associative;  
 (b) reprove Theorem 2.6.

### IV.3 Mechanics of Matrix Multiplication

In this subsection we consider matrix multiplication as a mechanical process, putting aside for the moment any implications about the underlying maps.

The striking thing about matrix multiplication is the way rows and columns combine. The  $i, j$  entry of the matrix product is the dot product of row  $i$  of the left matrix with column  $j$  of the right one. For instance, here a second row and



a third column combine to make a 2,3 entry.

$$\begin{pmatrix} 1 & 1 \\ 0 & 1 \\ 1 & 0 \end{pmatrix} \begin{pmatrix} 4 & 6 & 8 & 2 \\ 5 & 7 & 9 & 3 \end{pmatrix} = \begin{pmatrix} 9 & 13 & 17 & 5 \\ 5 & 7 & 9 & 3 \\ 4 & 6 & 8 & 2 \end{pmatrix}$$

We can view this as the left matrix acting by multiplying its rows, one at a time, into the columns of the right matrix. Or, another perspective is that the right matrix uses its columns to act on the left matrix's rows. Below, we will examine actions from the left and from the right for some simple matrices.

The action of a zero matrix is easy.

**3.1 Example** Multiplying by an appropriately-sized zero matrix from the left or from the right results in a zero matrix.

$$\begin{pmatrix} 0 & 0 \\ 0 & 0 \end{pmatrix} \begin{pmatrix} 1 & 3 & 2 \\ -1 & 1 & -1 \end{pmatrix} = \begin{pmatrix} 0 & 0 & 0 \\ 0 & 0 & 0 \end{pmatrix} \quad \begin{pmatrix} 2 & 3 \\ 1 & 4 \end{pmatrix} \begin{pmatrix} 0 & 0 \\ 0 & 0 \end{pmatrix} = \begin{pmatrix} 0 & 0 \\ 0 & 0 \end{pmatrix}$$

The next easiest to understand matrices, after the zero matrices, are the ones with a single nonzero entry.

**3.2 Definition** A matrix with all zeroes except for a one in the  $i, j$  entry is an  $i, j$  *unit* matrix.

**3.3 Example** This is the 1,2 unit matrix with three rows and two columns, multiplying from the left.

$$\begin{pmatrix} 0 & 1 \\ 0 & 0 \\ 0 & 0 \end{pmatrix} \begin{pmatrix} 5 & 6 \\ 7 & 8 \end{pmatrix} = \begin{pmatrix} 7 & 8 \\ 0 & 0 \\ 0 & 0 \end{pmatrix}$$

Acting from the left, an  $i, j$  unit matrix copies row  $j$  of the multiplicand into row  $i$  of the result. From the right an  $i, j$  unit matrix picks out column  $i$  of the multiplicand and copies it into column  $j$  of the result.

$$\begin{pmatrix} 1 & 2 & 3 \\ 4 & 5 & 6 \\ 7 & 8 & 9 \end{pmatrix} \begin{pmatrix} 0 & 1 \\ 0 & 0 \\ 0 & 0 \end{pmatrix} = \begin{pmatrix} 0 & 1 \\ 0 & 4 \\ 0 & 7 \end{pmatrix}$$

**3.4 Example** Rescaling these matrices simply rescales the result. This is the action from the left of the matrix that is twice the one in the prior example.

$$\begin{pmatrix} 0 & 2 \\ 0 & 0 \\ 0 & 0 \end{pmatrix} \begin{pmatrix} 5 & 6 \\ 7 & 8 \end{pmatrix} = \begin{pmatrix} 14 & 16 \\ 0 & 0 \\ 0 & 0 \end{pmatrix}$$

And this is the action of the matrix that is  $-3$  times the one from the prior example.

$$\begin{pmatrix} 1 & 2 & 3 \\ 4 & 5 & 6 \\ 7 & 8 & 9 \end{pmatrix} \begin{pmatrix} 0 & -3 \\ 0 & 0 \\ 0 & 0 \end{pmatrix} = \begin{pmatrix} 0 & -3 \\ 0 & -12 \\ 0 & -21 \end{pmatrix}$$

Next in complication are matrices with two nonzero entries. There are two cases. If a left-multiplier has entries in different rows then their actions don't interact.

### 3.5 Example

$$\begin{aligned} \begin{pmatrix} 1 & 0 & 0 \\ 0 & 0 & 2 \\ 0 & 0 & 0 \end{pmatrix} \begin{pmatrix} 1 & 2 & 3 \\ 4 & 5 & 6 \\ 7 & 8 & 9 \end{pmatrix} &= \left( \begin{pmatrix} 1 & 0 & 0 \\ 0 & 0 & 0 \\ 0 & 0 & 0 \end{pmatrix} + \begin{pmatrix} 0 & 0 & 0 \\ 0 & 0 & 2 \\ 0 & 0 & 0 \end{pmatrix} \right) \begin{pmatrix} 1 & 2 & 3 \\ 4 & 5 & 6 \\ 7 & 8 & 9 \end{pmatrix} \\ &= \begin{pmatrix} 1 & 2 & 3 \\ 0 & 0 & 0 \\ 0 & 0 & 0 \end{pmatrix} + \begin{pmatrix} 0 & 0 & 0 \\ 14 & 16 & 18 \\ 0 & 0 & 0 \end{pmatrix} \\ &= \begin{pmatrix} 1 & 2 & 3 \\ 14 & 16 & 18 \\ 0 & 0 & 0 \end{pmatrix} \end{aligned}$$

But if the left-multiplier's nonzero entries are in the same row then that row of the result is a combination.

### 3.6 Example

$$\begin{aligned} \begin{pmatrix} 1 & 0 & 2 \\ 0 & 0 & 0 \\ 0 & 0 & 0 \end{pmatrix} \begin{pmatrix} 1 & 2 & 3 \\ 4 & 5 & 6 \\ 7 & 8 & 9 \end{pmatrix} &= \left( \begin{pmatrix} 1 & 0 & 0 \\ 0 & 0 & 0 \\ 0 & 0 & 0 \end{pmatrix} + \begin{pmatrix} 0 & 0 & 2 \\ 0 & 0 & 0 \\ 0 & 0 & 0 \end{pmatrix} \right) \begin{pmatrix} 1 & 2 & 3 \\ 4 & 5 & 6 \\ 7 & 8 & 9 \end{pmatrix} \\ &= \begin{pmatrix} 1 & 2 & 3 \\ 0 & 0 & 0 \\ 0 & 0 & 0 \end{pmatrix} + \begin{pmatrix} 14 & 16 & 18 \\ 0 & 0 & 0 \\ 0 & 0 & 0 \end{pmatrix} \\ &= \begin{pmatrix} 15 & 18 & 21 \\ 0 & 0 & 0 \\ 0 & 0 & 0 \end{pmatrix} \end{aligned}$$

Right-multiplication acts in the same way, but with columns.

These observations about simple matrices extend to arbitrary ones.

**3.7 Example** Consider the columns of the product of two  $2 \times 2$  matrices.

$$\begin{pmatrix} g_{1,1} & g_{1,2} \\ g_{2,1} & g_{2,2} \end{pmatrix} \begin{pmatrix} h_{1,1} & h_{1,2} \\ h_{2,1} & h_{2,2} \end{pmatrix} = \begin{pmatrix} g_{1,1}h_{1,1} + g_{1,2}h_{2,1} & g_{1,1}h_{1,2} + g_{1,2}h_{2,2} \\ g_{2,1}h_{1,1} + g_{2,2}h_{2,1} & g_{2,1}h_{1,2} + g_{2,2}h_{2,2} \end{pmatrix}$$

Each column is the result of multiplying  $G$  by the corresponding column of  $H$ .

$$G \begin{pmatrix} h_{1,1} \\ h_{2,1} \end{pmatrix} = \begin{pmatrix} g_{1,1}h_{1,1} + g_{1,2}h_{2,1} \\ g_{2,1}h_{1,1} + g_{2,2}h_{2,1} \end{pmatrix} \quad G \begin{pmatrix} h_{1,2} \\ h_{2,2} \end{pmatrix} = \begin{pmatrix} g_{1,1}h_{1,2} + g_{1,2}h_{2,2} \\ g_{2,1}h_{1,2} + g_{2,2}h_{2,2} \end{pmatrix}$$

**3.8 Lemma** In a product of two matrices  $G$  and  $H$ , the columns of  $GH$  are formed by taking  $G$  times the columns of  $H$

$$G \cdot \left( \begin{array}{c|c|c} \vdots & & \vdots \\ \vec{h}_1 & \cdots & \vec{h}_n \\ \vdots & & \vdots \end{array} \right) = \left( \begin{array}{c|c|c} \vdots & & \vdots \\ G \cdot \vec{h}_1 & \cdots & G \cdot \vec{h}_n \\ \vdots & & \vdots \end{array} \right)$$

and the rows of  $GH$  are formed by taking the rows of  $G$  times  $H$

$$\begin{pmatrix} \cdots & \vec{g}_1 & \cdots \\ \vdots & & \\ \cdots & \vec{g}_r & \cdots \end{pmatrix} \cdot H = \begin{pmatrix} \cdots & \vec{g}_1 \cdot H & \cdots \\ \vdots & & \\ \cdots & \vec{g}_r \cdot H & \cdots \end{pmatrix}$$

(ignoring the extra parentheses).

**PROOF** We will check that in a product of  $2 \times 2$  matrices, the rows of the product equal the product of the rows of  $G$  with the entire matrix  $H$ .

$$\begin{aligned} \begin{pmatrix} g_{1,1} & g_{1,2} \\ g_{2,1} & g_{2,2} \end{pmatrix} \begin{pmatrix} h_{1,1} & h_{1,2} \\ h_{2,1} & h_{2,2} \end{pmatrix} &= \begin{pmatrix} \begin{pmatrix} g_{1,1} & g_{1,2} \end{pmatrix} H \\ \begin{pmatrix} g_{2,1} & g_{2,2} \end{pmatrix} H \end{pmatrix} \\ &= \begin{pmatrix} \begin{pmatrix} g_{1,1}h_{1,1} + g_{1,2}h_{2,1} & g_{1,1}h_{1,2} + g_{1,2}h_{2,2} \\ g_{2,1}h_{1,1} + g_{2,2}h_{2,1} & g_{2,1}h_{1,2} + g_{2,2}h_{2,2} \end{pmatrix} \end{pmatrix} \end{aligned}$$

We will leave the more general check as an exercise.

QED

An application of those observations is that there is a matrix that just copies out the rows and columns.

**3.9 Definition** The *main diagonal* (or *principle diagonal* or *diagonal*) of a square matrix goes from the upper left to the lower right.

**3.10 Definition** An *identity matrix* is square and has all entries zero except for ones in the main diagonal.

$$I_{n \times n} = \begin{pmatrix} 1 & 0 & \cdots & 0 \\ 0 & 1 & \cdots & 0 \\ \vdots & & & \\ 0 & 0 & \cdots & 1 \end{pmatrix}$$

**3.11 Example** Here is the  $2 \times 2$  identity matrix leaving its multiplicand unchanged when it acts from the right.

$$\begin{pmatrix} 1 & -2 \\ 0 & -2 \\ 1 & -1 \\ 4 & 3 \end{pmatrix} \begin{pmatrix} 1 & 0 \\ 0 & 1 \end{pmatrix} = \begin{pmatrix} 1 & -2 \\ 0 & -2 \\ 1 & -1 \\ 4 & 3 \end{pmatrix}$$

**3.12 Example** Here the  $3 \times 3$  identity leaves its multiplicand unchanged both from the left

$$\begin{pmatrix} 1 & 0 & 0 \\ 0 & 1 & 0 \\ 0 & 0 & 1 \end{pmatrix} \begin{pmatrix} 2 & 3 & 6 \\ 1 & 3 & 8 \\ -7 & 1 & 0 \end{pmatrix} = \begin{pmatrix} 2 & 3 & 6 \\ 1 & 3 & 8 \\ -7 & 1 & 0 \end{pmatrix}$$

and from the right.

$$\begin{pmatrix} 2 & 3 & 6 \\ 1 & 3 & 8 \\ -7 & 1 & 0 \end{pmatrix} \begin{pmatrix} 1 & 0 & 0 \\ 0 & 1 & 0 \\ 0 & 0 & 1 \end{pmatrix} = \begin{pmatrix} 2 & 3 & 6 \\ 1 & 3 & 8 \\ -7 & 1 & 0 \end{pmatrix}$$

In short, an identity matrix is the identity element of the set of  $n \times n$  matrices with respect to the operation of matrix multiplication.

We next see two ways to generalize the identity matrix. The first is that if we relax the ones to arbitrary reals then the resulting matrix will rescale whole rows or columns.

**3.13 Definition** A *diagonal matrix* is square and has zeros off the main diagonal.

$$\begin{pmatrix} a_{1,1} & 0 & \dots & 0 \\ 0 & a_{2,2} & \dots & 0 \\ \vdots & \vdots & \ddots & \vdots \\ 0 & 0 & \dots & a_{n,n} \end{pmatrix}$$

**3.14 Example** From the left, the action of multiplication by a diagonal matrix is to rescale the rows.

$$\begin{pmatrix} 2 & 0 \\ 0 & -1 \end{pmatrix} \begin{pmatrix} 2 & 1 & 4 & -1 \\ -1 & 3 & 4 & 4 \end{pmatrix} = \begin{pmatrix} 4 & 2 & 8 & -2 \\ 1 & -3 & -4 & -4 \end{pmatrix}$$

From the right such a matrix rescales the columns.

$$\begin{pmatrix} 1 & 2 & 1 \\ 2 & 2 & 2 \end{pmatrix} \begin{pmatrix} 3 & 0 & 0 \\ 0 & 2 & 0 \\ 0 & 0 & -2 \end{pmatrix} = \begin{pmatrix} 3 & 4 & -2 \\ 6 & 4 & -4 \end{pmatrix}$$

The second generalization of identity matrices is that we can put a single one in each row and column in ways other than putting them down the diagonal.

**3.15 Definition** A *permutation matrix* is square and is all zeros except for a single one in each row and column.

**3.16 Example** From the left these matrices permute rows.

$$\begin{pmatrix} 0 & 0 & 1 \\ 1 & 0 & 0 \\ 0 & 1 & 0 \end{pmatrix} \begin{pmatrix} 1 & 2 & 3 \\ 4 & 5 & 6 \\ 7 & 8 & 9 \end{pmatrix} = \begin{pmatrix} 7 & 8 & 9 \\ 1 & 2 & 3 \\ 4 & 5 & 6 \end{pmatrix}$$

From the right they permute columns.

$$\begin{pmatrix} 1 & 2 & 3 \\ 4 & 5 & 6 \\ 7 & 8 & 9 \end{pmatrix} \begin{pmatrix} 0 & 0 & 1 \\ 1 & 0 & 0 \\ 0 & 1 & 0 \end{pmatrix} = \begin{pmatrix} 2 & 3 & 1 \\ 5 & 6 & 4 \\ 8 & 9 & 7 \end{pmatrix}$$

We finish this subsection by applying these observations to get matrices that perform Gauss' method and Gauss-Jordan reduction.

**3.17 Example** We have seen how to produce a matrix that will rescale rows. Multiplying by this diagonal matrix rescales the second row of the other matrix by a factor of three.

$$\begin{pmatrix} 1 & 0 & 0 \\ 0 & 3 & 0 \\ 0 & 0 & 1 \end{pmatrix} \begin{pmatrix} 0 & 2 & 1 & 1 \\ 0 & 1/3 & 1 & -1 \\ 1 & 0 & 2 & 0 \end{pmatrix} = \begin{pmatrix} 0 & 2 & 1 & 1 \\ 0 & 1 & 3 & -3 \\ 1 & 0 & 2 & 0 \end{pmatrix}$$

We have seen how to produce a matrix that will swap rows. Multiplying by this permutation matrix swaps the first and third rows.

$$\begin{pmatrix} 0 & 0 & 1 \\ 0 & 1 & 0 \\ 1 & 0 & 0 \end{pmatrix} \begin{pmatrix} 0 & 2 & 1 & 1 \\ 0 & 1 & 3 & -3 \\ 1 & 0 & 2 & 0 \end{pmatrix} = \begin{pmatrix} 1 & 0 & 2 & 0 \\ 0 & 1 & 3 & -3 \\ 0 & 2 & 1 & 1 \end{pmatrix}$$

To see how to perform a row combination, we observe something about those two examples. The matrix that rescales the second row by a factor of three arises in this way from the identity.

$$\begin{pmatrix} 1 & 0 & 0 \\ 0 & 1 & 0 \\ 0 & 0 & 1 \end{pmatrix} \xrightarrow{3\rho_2} \begin{pmatrix} 1 & 0 & 0 \\ 0 & 3 & 0 \\ 0 & 0 & 1 \end{pmatrix}$$

Similarly, the matrix that swaps first and third rows arises in this way.

$$\begin{pmatrix} 1 & 0 & 0 \\ 0 & 1 & 0 \\ 0 & 0 & 1 \end{pmatrix} \xrightarrow{\rho_1 \leftrightarrow \rho_3} \begin{pmatrix} 0 & 0 & 1 \\ 0 & 1 & 0 \\ 1 & 0 & 0 \end{pmatrix}$$

**3.18 Example** The  $3 \times 3$  matrix that arises as

$$\begin{pmatrix} 1 & 0 & 0 \\ 0 & 1 & 0 \\ 0 & 0 & 1 \end{pmatrix} \xrightarrow{-2\rho_2 + \rho_3} \begin{pmatrix} 1 & 0 & 0 \\ 0 & 1 & 0 \\ 0 & -2 & 1 \end{pmatrix}$$

will, when it acts from the left, perform the combination operation  $-2\rho_2 + \rho_3$ .

$$\begin{pmatrix} 1 & 0 & 0 \\ 0 & 1 & 0 \\ 0 & -2 & 1 \end{pmatrix} \begin{pmatrix} 1 & 0 & 2 & 0 \\ 0 & 1 & 3 & -3 \\ 0 & 2 & 1 & 1 \end{pmatrix} = \begin{pmatrix} 1 & 0 & 2 & 0 \\ 0 & 1 & 3 & -3 \\ 0 & 0 & -5 & 7 \end{pmatrix}$$

**3.19 Definition** The *elementary reduction matrices* result from applying a one Gaussian operation to an identity matrix.

- (1)  $I \xrightarrow{k\rho_i} M_i(k)$  for  $k \neq 0$
- (2)  $I \xrightarrow{\rho_i \leftrightarrow \rho_j} P_{i,j}$  for  $i \neq j$
- (3)  $I \xrightarrow{k\rho_i + \rho_j} C_{i,j}(k)$  for  $i \neq j$

**3.20 Lemma** Gaussian reduction can be done through matrix multiplication.

- (1) If  $H \xrightarrow{k\rho_i} G$  then  $M_i(k)H = G$ .
- (2) If  $H \xrightarrow{\rho_i \leftrightarrow \rho_j} G$  then  $P_{i,j}H = G$ .
- (3) If  $H \xrightarrow{k\rho_i + \rho_j} G$  then  $C_{i,j}(k)H = G$ .

PROOF Clear.

QED

**3.21 Example** This is the first system, from the first chapter, on which we performed Gauss' method.

$$\begin{array}{rcl} 3x_3 & = & 9 \\ x_1 + 5x_2 - 2x_3 & = & 2 \\ (1/3)x_1 + 2x_2 & = & 3 \end{array}$$

We can reduce it with matrix multiplication. Swap the first and third rows,

$$\begin{pmatrix} 0 & 0 & 1 \\ 0 & 1 & 0 \\ 1 & 0 & 0 \end{pmatrix} \begin{pmatrix} 0 & 0 & 3 & | & 9 \\ 1 & 5 & -2 & | & 2 \\ 1/3 & 2 & 0 & | & 3 \end{pmatrix} = \begin{pmatrix} 1/3 & 2 & 0 & | & 3 \\ 1 & 5 & -2 & | & 2 \\ 0 & 0 & 3 & | & 9 \end{pmatrix}$$

triple the first row,

$$\begin{pmatrix} 3 & 0 & 0 \\ 0 & 1 & 0 \\ 0 & 0 & 1 \end{pmatrix} \begin{pmatrix} 1/3 & 2 & 0 & | & 3 \\ 1 & 5 & -2 & | & 2 \\ 0 & 0 & 3 & | & 9 \end{pmatrix} = \begin{pmatrix} 1 & 6 & 0 & | & 9 \\ 1 & 5 & -2 & | & 2 \\ 0 & 0 & 3 & | & 9 \end{pmatrix}$$

and then add  $-1$  times the first row to the second.

$$\begin{pmatrix} 1 & 0 & 0 \\ -1 & 1 & 0 \\ 0 & 0 & 1 \end{pmatrix} \begin{pmatrix} 1 & 6 & 0 & | & 9 \\ 1 & 5 & -2 & | & 2 \\ 0 & 0 & 3 & | & 9 \end{pmatrix} = \begin{pmatrix} 1 & 6 & 0 & | & 9 \\ 0 & -1 & -2 & | & -7 \\ 0 & 0 & 3 & | & 9 \end{pmatrix}$$

Now back substitution will give the solution.

**3.22 Example** Gauss-Jordan reduction works the same way. For the matrix ending the prior example, first adjust the leading entries

$$\begin{pmatrix} 1 & 0 & 0 \\ 0 & -1 & 0 \\ 0 & 0 & 1/3 \end{pmatrix} \begin{pmatrix} 1 & 6 & 0 & | & 9 \\ 0 & -1 & -2 & | & -7 \\ 0 & 0 & 3 & | & 9 \end{pmatrix} = \begin{pmatrix} 1 & 6 & 0 & | & 9 \\ 0 & 1 & 2 & | & 7 \\ 0 & 0 & 1 & | & 3 \end{pmatrix}$$

and to finish, clear the third column and then the second column.

$$\begin{pmatrix} 1 & -6 & 0 \\ 0 & 1 & 0 \\ 0 & 0 & 1 \end{pmatrix} \begin{pmatrix} 1 & 0 & 0 \\ 0 & 1 & -2 \\ 0 & 0 & 1 \end{pmatrix} \begin{pmatrix} 1 & 6 & 0 & | & 9 \\ 0 & 1 & 2 & | & 7 \\ 0 & 0 & 1 & | & 3 \end{pmatrix} = \begin{pmatrix} 1 & 0 & 0 & | & 3 \\ 0 & 1 & 0 & | & 1 \\ 0 & 0 & 1 & | & 3 \end{pmatrix}$$

**3.23 Corollary** For any matrix  $H$  there are elementary reduction matrices  $R_1, \dots, R_r$  such that  $R_r \cdot R_{r-1} \cdots R_1 \cdot H$  is in reduced echelon form.

Until now we have taken the point of view that our primary objects of study are vector spaces and the maps between them, and have adopted matrices only for computational convenience. This subsection show that this isn't the whole story. Understanding matrices operations by how the entries combine can be useful also. In the rest of this book we shall continue to focus on maps as the primary objects but we will be pragmatic—if the matrix point of view gives some clearer idea then we will go with it.

### Exercises

- ✓ **3.24** Predict the result of each multiplication by an elementary reduction matrix, and then check by multiplying it out.

$$(a) \begin{pmatrix} 3 & 0 \\ 0 & 0 \end{pmatrix} \begin{pmatrix} 1 & 2 \\ 3 & 4 \end{pmatrix} \quad (b) \begin{pmatrix} 4 & 0 \\ 0 & 2 \end{pmatrix} \begin{pmatrix} 1 & 2 \\ 3 & 4 \end{pmatrix} \quad (c) \begin{pmatrix} 1 & 0 \\ -2 & 1 \end{pmatrix} \begin{pmatrix} 1 & 2 \\ 3 & 4 \end{pmatrix}$$

$$(d) \begin{pmatrix} 1 & 2 \\ 3 & 4 \end{pmatrix} \begin{pmatrix} 1 & -1 \\ 0 & 1 \end{pmatrix} \quad (e) \begin{pmatrix} 1 & 2 \\ 3 & 4 \end{pmatrix} \begin{pmatrix} 0 & 1 \\ 1 & 0 \end{pmatrix}$$

- ✓ **3.25** This table gives the number of hours of each type done by each worker, and the associated pay rates. Use matrices to compute the wages due.

	<i>regular</i>	<i>overtime</i>		<i>wage</i>
Alan	40	12	regular	\$25.00
Betty	35	6	overtime	\$45.00
Catherine	40	18		
Donald	28	0		

*Remark.* This illustrates that in practice we often want to compute linear combinations of rows and columns in a context where we really aren't interested in any associated linear maps.

- ✓ **3.26** The need to take linear combinations of rows and columns in tables of numbers arises often in practice. For instance, this is a map of part of Vermont and New York.

In part because of Lake Champlain, there are no roads directly connecting some pairs of towns. For instance, there is no way to go from Winooski to Grand Isle without going through Colchester. (To simplify the graph many other roads and towns have been omitted. From top to bottom of this map is about forty miles.)

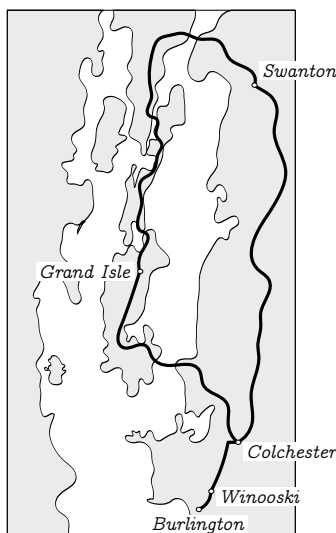

- (a) The *incidence matrix* of a map is the square matrix whose  $i, j$  entry is the number of roads from city  $i$  to city  $j$ . Produce the incidence matrix of this map (take the cities in alphabetical order).
- (b) A matrix is *symmetric* if it equals its transpose. Show that an incidence matrix is symmetric. (These are all two-way streets. Vermont doesn't have many one-way streets.)
- (c) What is the significance of the square of the incidence matrix? The cube?

3.27 Find the product of this matrix with its transpose.

$$\begin{pmatrix} \cos \theta & -\sin \theta \\ \sin \theta & \cos \theta \end{pmatrix}$$

- ✓ 3.28 Prove that the diagonal matrices form a subspace of  $\mathcal{M}_{n \times n}$ . What is its dimension?
- 3.29 Does the identity matrix represent the identity map if the bases are unequal?
- 3.30 Show that every multiple of the identity commutes with every square matrix. Are there other matrices that commute with all square matrices?
- 3.31 Prove or disprove: nonsingular matrices commute.
- ✓ 3.32 Show that the product of a permutation matrix and its transpose is an identity matrix.
- 3.33 Show that if the first and second rows of  $G$  are equal then so are the first and second rows of  $GH$ . Generalize.
- 3.34 Describe the product of two diagonal matrices.
- 3.35 Write

$$\begin{pmatrix} 1 & 0 \\ -3 & 3 \end{pmatrix}$$

as the product of two elementary reduction matrices.

- ✓ 3.36 Show that if  $G$  has a row of zeros then  $GH$  (if defined) has a row of zeros. Does that work for columns?
- 3.37 Show that the set of unit matrices forms a basis for  $\mathcal{M}_{n \times m}$ .
- 3.38 Find the formula for the  $n$ -th power of this matrix.

$$\begin{pmatrix} 1 & 1 \\ 1 & 0 \end{pmatrix}$$

- ✓ 3.39 The *trace* of a square matrix is the sum of the entries on its diagonal (its significance appears in Chapter Five). Show that  $\text{Tr}(GH) = \text{Tr}(HG)$ .
- ✓ 3.40 A square matrix is *upper triangular* if its only nonzero entries lie above, or on, the diagonal. Show that the product of two upper triangular matrices is upper triangular. Does this hold for lower triangular also?
- 3.41 A square matrix is a *Markov matrix* if each entry is between zero and one and the sum along each row is one. Prove that a product of Markov matrices is Markov.
- ✓ 3.42 Give an example of two matrices of the same rank with squares of differing rank.
- 3.43 Combine the two generalizations of the identity matrix, the one allowing entries to be other than ones, and the one allowing the single one in each row and column to be off the diagonal. What is the action of this type of matrix?
- 3.44 On a computer multiplications have traditionally been more costly than additions, so people have tried to in reduce the number of multiplications used to compute a matrix product.
- (a) How many real number multiplications do we need in the formula we gave for the product of a  $m \times r$  matrix and a  $r \times n$  matrix?



- (b) Matrix multiplication is associative, so all associations yield the same result. The cost in number of multiplications, however, varies. Find the association requiring the fewest real number multiplications to compute the matrix product of a  $5 \times 10$  matrix, a  $10 \times 20$  matrix, a  $20 \times 5$  matrix, and a  $5 \times 1$  matrix.
- (c) (*Very hard.*) Find a way to multiply two  $2 \times 2$  matrices using only seven multiplications instead of the eight suggested by the naive approach.
- ? 3.45 [Putnam, 1990, A-5] If  $A$  and  $B$  are square matrices of the same size such that  $ABAB = 0$ , does it follow that  $BABA = 0$ ?
- 3.46 [Am. Math. Mon., Dec. 1966] Demonstrate these four assertions to get an alternate proof that column rank equals row rank.
- $\vec{y} \cdot \vec{y} = \vec{0}$  iff  $\vec{y} = \vec{0}$ .
  - $A\vec{x} = \vec{0}$  iff  $A^{\text{trans}}A\vec{x} = \vec{0}$ .
  - $\dim(\mathcal{R}(A)) = \dim(\mathcal{R}(A^{\text{trans}}A))$ .
  - $\text{col rank}(A) = \text{col rank}(A^{\text{trans}}) = \text{row rank}(A)$ .
- 3.47 [Ackerson] Prove (where  $A$  is an  $n \times n$  matrix and so defines a transformation of any  $n$ -dimensional space  $V$  with respect to  $B$ ,  $B$  where  $B$  is a basis) that  $\dim(\mathcal{R}(A) \cap \mathcal{N}(A)) = \dim(\mathcal{R}(A)) - \dim(\mathcal{R}(A^2))$ . Conclude
- $\mathcal{N}(A) \subset \mathcal{R}(A)$  iff  $\dim(\mathcal{N}(A)) = \dim(\mathcal{R}(A)) - \dim(\mathcal{R}(A^2))$ ;
  - $\mathcal{R}(A) \subseteq \mathcal{N}(A)$  iff  $A^2 = 0$ ;
  - $\mathcal{R}(A) = \mathcal{N}(A)$  iff  $A^2 = 0$  and  $\dim(\mathcal{N}(A)) = \dim(\mathcal{R}(A))$ ;
  - $\dim(\mathcal{R}(A) \cap \mathcal{N}(A)) = 0$  iff  $\dim(\mathcal{R}(A)) = \dim(\mathcal{R}(A^2))$ ;
  - (Requires the Direct Sum subsection, which is optional.)  $V = \mathcal{R}(A) \oplus \mathcal{N}(A)$  iff  $\dim(\mathcal{R}(A)) = \dim(\mathcal{R}(A^2))$ .

## IV.4 Inverses

We finish this section by considering how to represent the inverse of a linear map.

We first recall some things about inverses.\* Where  $\pi: \mathbb{R}^3 \rightarrow \mathbb{R}^2$  is the projection map and  $\iota: \mathbb{R}^2 \rightarrow \mathbb{R}^3$  is the embedding

$$\begin{pmatrix} x \\ y \\ z \end{pmatrix} \xrightarrow{\pi} \begin{pmatrix} x \\ y \end{pmatrix} \quad \begin{pmatrix} x \\ y \end{pmatrix} \xrightarrow{\iota} \begin{pmatrix} x \\ y \\ 0 \end{pmatrix}$$

then the composition  $\pi \circ \iota$  is the identity map on  $\mathbb{R}^2$ .

$$\begin{pmatrix} x \\ y \end{pmatrix} \xrightarrow{\iota} \begin{pmatrix} x \\ y \\ 0 \end{pmatrix} \xrightarrow{\pi} \begin{pmatrix} x \\ y \end{pmatrix}$$

We say that  $\iota$  is a *right inverse map* of  $\pi$  or, what is the same thing, that  $\pi$  is a *left inverse* of  $\iota$ . However, composition in the other order  $\iota \circ \pi$  doesn't give

\* More information on function inverses is in the appendix.

the identity map—here is a vector that is not sent to itself under  $\iota \circ \pi$ .

$$\begin{pmatrix} 0 \\ 0 \\ 1 \end{pmatrix} \xrightarrow{\pi} \begin{pmatrix} 0 \\ 0 \end{pmatrix} \xrightarrow{\iota} \begin{pmatrix} 0 \\ 0 \\ 0 \end{pmatrix}$$

In fact,  $\pi$  has no left inverse at all. For, if  $f$  were to be a left inverse of  $\pi$  then we would have

$$\begin{pmatrix} x \\ y \\ z \end{pmatrix} \xrightarrow{\pi} \begin{pmatrix} x \\ y \end{pmatrix} \xrightarrow{f} \begin{pmatrix} x \\ y \\ z \end{pmatrix}$$

for all of the infinitely many  $z$ 's. But no function can send a single argument to more than one value. (An example of a function with no inverse on either side is the zero transformation on  $\mathbb{R}^2$ .)

Some functions have a *two-sided inverse*, another function that is the inverse of the first both from the left and from the right. For instance, the map given by  $\vec{v} \mapsto 2 \cdot \vec{v}$  has the two-sided inverse  $\vec{v} \mapsto (1/2) \cdot \vec{v}$ . The appendix shows that a function has a two-sided inverse if and only if it is both one-to-one and onto. The appendix also shows that if a function  $f$  has a two-sided inverse then it is unique, and so we call it 'the' inverse, and denote it  $f^{-1}$ .

In addition, recall that we have shown in Theorem II.2.20 that if a linear map has a two-sided inverse then that inverse is also linear.

Thus, our goal in this subsection is, where a linear  $h$  has an inverse, to find the relationship between  $\text{Rep}_{B,D}(h)$  and  $\text{Rep}_{D,B}(h^{-1})$ .

**4.1 Definition** A matrix  $G$  is a *left inverse matrix* of the matrix  $H$  if  $GH$  is the identity matrix. It is a *right inverse matrix* if  $HG$  is the identity. A matrix  $H$  with a two-sided inverse is an *invertible matrix*. That two-sided inverse is the *inverse matrix* and is denoted  $H^{-1}$ .

Because of the correspondence between linear maps and matrices, statements about map inverses translate into statements about matrix inverses.

**4.2 Lemma** If a matrix has both a left inverse and a right inverse then the two are equal.

**4.3 Theorem** A matrix is invertible if and only if it is nonsingular.

**PROOF** (*For both results.*) Given a matrix  $H$ , fix spaces of appropriate dimension for the domain and codomain. Fix bases for these spaces. With respect to these bases,  $H$  represents a map  $h$ . The statements are true about the map and therefore they are true about the matrix. QED

**4.4 Lemma** A product of invertible matrices is invertible: if  $G$  and  $H$  are invertible and if  $GH$  is defined then  $GH$  is invertible and  $(GH)^{-1} = H^{-1}G^{-1}$ .

**PROOF** Because the two matrices are invertible they are square. Because their product is defined they must be square of the same dimension,  $n \times n$ . So by fixing a basis for  $\mathbb{R}^n$  — we can use the standard basis — we get maps  $g, h: \mathbb{R}^n \rightarrow \mathbb{R}^n$  that are associated with the matrices,  $G = \text{Rep}_{\varepsilon_n, \varepsilon_n}(g)$  and  $H = \text{Rep}_{\varepsilon_n, \varepsilon_n}(h)$ .

Consider  $h^{-1}g^{-1}$ . By the prior paragraph this composition is defined. This map is a two-sided inverse of  $gh$  since  $(h^{-1}g^{-1})(gh) = h^{-1}(\text{id})h = h^{-1}h = \text{id}$  and  $(gh)(h^{-1}g^{-1}) = g(\text{id})g^{-1} = gg^{-1} = \text{id}$ . The matrices representing the maps reflect this equality. QED

This is the arrow diagram giving the relationship between map inverses and matrix inverses. It is a special case of the diagram for function composition and matrix multiplication.

$$\begin{array}{ccc}
 & W_{\text{wrt } C} & \\
 \begin{array}{c} \nearrow h \\ \text{H} \end{array} & & \begin{array}{c} \searrow h^{-1} \\ H^{-1} \end{array} \\
 V_{\text{wrt } B} & \xrightarrow[\text{I}]{\text{id}} & V_{\text{wrt } B}
 \end{array}$$

Beyond its place in our general program of seeing how to represent map operations, another reason for our interest in inverses comes from solving linear systems. A linear system is equivalent to a matrix equation, as here.

$$\begin{array}{l}
 x_1 + x_2 = 3 \\
 2x_1 - x_2 = 2
 \end{array}
 \iff
 \begin{pmatrix} 1 & 1 \\ 2 & -1 \end{pmatrix}
 \begin{pmatrix} x_1 \\ x_2 \end{pmatrix}
 =
 \begin{pmatrix} 3 \\ 2 \end{pmatrix}
 \quad (*)$$

By fixing spaces and bases (for instance,  $\mathbb{R}^2, \mathbb{R}^2$  with the standard bases), we take the matrix  $H$  to represent a map  $h$ . The matrix equation then becomes this linear map equation.

$$h(\vec{x}) = \vec{d} \quad (**)$$

Asking for a solution to  $(*)$  is the same as asking in  $(**)$  for the domain vector  $\vec{x}$  that  $h$  maps to the result  $\vec{d}$ . If we had a left inverse map  $g$  then we could apply it to both sides  $g \circ h(\vec{x}) = g(\vec{d})$ , which simplifies to  $\vec{x} = g(\vec{d})$ . In terms of the matrices, we multiply  $\text{Rep}_{C, B}(g) \cdot \text{Rep}_C(\vec{d})$  to get  $\text{Rep}_B(\vec{x})$ .

**4.5 Example** We can find a left inverse for the matrix just given

$$\begin{pmatrix} m & n \\ p & q \end{pmatrix}
 \begin{pmatrix} 1 & 1 \\ 2 & -1 \end{pmatrix}
 =
 \begin{pmatrix} 1 & 0 \\ 0 & 1 \end{pmatrix}$$

by using Gauss' method to solve the resulting linear system.

$$\begin{array}{rcl}
 m + 2n & = & 1 \\
 m - n & = & 0 \\
 p + 2q & = & 0 \\
 p - q & = & 1
 \end{array}$$

Answer:  $m = 1/3$ ,  $n = 1/3$ ,  $p = 2/3$ , and  $q = -1/3$ . This matrix is actually the two-sided inverse of  $H$ ; the check is easy. With it we can solve the system (\*) above.

$$\begin{pmatrix} x \\ y \end{pmatrix} = \begin{pmatrix} 1/3 & 1/3 \\ 2/3 & -1/3 \end{pmatrix} \begin{pmatrix} 3 \\ 2 \end{pmatrix} = \begin{pmatrix} 5/3 \\ 4/3 \end{pmatrix}$$

**4.6 Remark** Why do this when we have Gauss' method? Beyond the conceptual appeal of representing the map inverse operation, solving linear systems this way has at least two advantages.

First, once we have done the work of finding an inverse then solving a system with the same coefficients but different constants is fast: if we change the entries on the right of the system (\*) then we get a related problem

$$\begin{pmatrix} 1 & 1 \\ 2 & -1 \end{pmatrix} \begin{pmatrix} x \\ y \end{pmatrix} = \begin{pmatrix} 5 \\ 1 \end{pmatrix}$$

that our inverse method solves quickly.

$$\begin{pmatrix} x \\ y \end{pmatrix} = \begin{pmatrix} 1/3 & 1/3 \\ 2/3 & -1/3 \end{pmatrix} \begin{pmatrix} 5 \\ 1 \end{pmatrix} = \begin{pmatrix} 2 \\ 3 \end{pmatrix}$$

Another advantage of inverses is that we can explore a system's sensitivity to changes in the constants. For example, tweaking the 3 on the right of the system (\*) to

$$\begin{pmatrix} 1 & 1 \\ 2 & -1 \end{pmatrix} \begin{pmatrix} x_1 \\ x_2 \end{pmatrix} = \begin{pmatrix} 3.01 \\ 2 \end{pmatrix}$$

and solving with the inverse

$$\begin{pmatrix} 1/3 & 1/3 \\ 2/3 & -1/3 \end{pmatrix} \begin{pmatrix} 3.01 \\ 2 \end{pmatrix} = \begin{pmatrix} (1/3)(3.01) + (1/3)(2) \\ (2/3)(3.01) - (1/3)(2) \end{pmatrix}$$

shows that the first component of the solution changes by  $1/3$  of the tweak, while the second component moves by  $2/3$  of the tweak. This is *sensitivity analysis*. For instance, we could use it to decide how accurately we must specify the data in a linear model to ensure that the solution has a desired accuracy.

We finish by describing the computational procedure that we shall use to find the inverse matrix.

**4.7 Lemma** A matrix  $H$  is invertible if and only if it can be written as the product of elementary reduction matrices. We can compute the inverse by applying to the identity matrix the same row steps, in the same order, as we use to Gauss-Jordan reduce  $H$ .

**PROOF** The matrix  $H$  is invertible if and only if it is nonsingular and thus Gauss-Jordan reduces to the identity. By Corollary 3.23 we can do this reduction with elementary matrices.

$$R_r \cdot R_{r-1} \dots R_1 \cdot H = I \tag{*}$$

For the first sentence of the result, recall that elementary matrices are invertible and that their inverses are also elementary. Apply  $R_r^{-1}$  from the left to both sides of (\*). Then apply  $R_{r-1}^{-1}$ , etc. The result gives  $H$  as the product of elementary matrices  $H = R_1^{-1} \cdots R_r^{-1} \cdot I$  (the  $I$  here covers the trivial  $r = 0$  case).

For the second sentence, rewrite (\*) as  $(R_r \cdot R_{r-1} \cdots R_1) \cdot H = I$  to recognize that  $H^{-1} = R_r \cdot R_{r-1} \cdots R_1 \cdot I$ . Restated, applying  $R_1$  to the identity, followed by  $R_2$ , etc., yields the inverse of  $H$ . QED

**4.8 Example** To find the inverse of

$$\begin{pmatrix} 1 & 1 \\ 2 & -1 \end{pmatrix}$$

we do Gauss-Jordan reduction, meanwhile performing the same operations on the identity. For clerical convenience we write the matrix and the identity side-by-side, and do the reduction steps together.

$$\begin{aligned} \left( \begin{array}{cc|cc} 1 & 1 & 1 & 0 \\ 2 & -1 & 0 & 1 \end{array} \right) & \xrightarrow{-2\rho_1+\rho_2} \left( \begin{array}{cc|cc} 1 & 1 & 1 & 0 \\ 0 & -3 & -2 & 1 \end{array} \right) \\ & \xrightarrow{-1/3\rho_2} \left( \begin{array}{cc|cc} 1 & 1 & 1 & 0 \\ 0 & 1 & 2/3 & -1/3 \end{array} \right) \\ & \xrightarrow{-\rho_2+\rho_1} \left( \begin{array}{cc|cc} 1 & 0 & 1/3 & 1/3 \\ 0 & 1 & 2/3 & -1/3 \end{array} \right) \end{aligned}$$

This calculation has found the inverse.

$$\begin{pmatrix} 1 & 1 \\ 2 & -1 \end{pmatrix}^{-1} = \begin{pmatrix} 1/3 & 1/3 \\ 2/3 & -1/3 \end{pmatrix}$$

**4.9 Example** This one happens to start with a row swap.

$$\begin{aligned} \left( \begin{array}{ccc|ccc} 0 & 3 & -1 & 1 & 0 & 0 \\ 1 & 0 & 1 & 0 & 1 & 0 \\ 1 & -1 & 0 & 0 & 0 & 1 \end{array} \right) & \xrightarrow{\rho_1 \leftrightarrow \rho_2} \left( \begin{array}{ccc|ccc} 1 & 0 & 1 & 0 & 1 & 0 \\ 0 & 3 & -1 & 1 & 0 & 0 \\ 1 & -1 & 0 & 0 & 0 & 1 \end{array} \right) \\ & \xrightarrow{-\rho_1+\rho_3} \left( \begin{array}{ccc|ccc} 1 & 0 & 1 & 0 & 1 & 0 \\ 0 & 3 & -1 & 1 & 0 & 0 \\ 0 & -1 & -1 & 0 & -1 & 1 \end{array} \right) \\ & \vdots \\ & \longrightarrow \left( \begin{array}{ccc|ccc} 1 & 0 & 0 & 1/4 & 1/4 & 3/4 \\ 0 & 1 & 0 & 1/4 & 1/4 & -1/4 \\ 0 & 0 & 1 & -1/4 & 3/4 & -3/4 \end{array} \right) \end{aligned}$$

**4.10 Example** We can detect a non-invertible matrix when the left half won't reduce to the identity.

$$\left( \begin{array}{cc|cc} 1 & 1 & 1 & 0 \\ 2 & 2 & 0 & 1 \end{array} \right) \xrightarrow{-2\rho_1+\rho_2} \left( \begin{array}{cc|cc} 1 & 1 & 1 & 0 \\ 0 & 0 & -2 & 1 \end{array} \right)$$

With this procedure we can give a formula for the inverse of a general  $2 \times 2$  matrix, which is worth memorizing. But larger matrices have more complex formulas so we will wait for more explanation in the next chapter.

**4.11 Corollary** The inverse for a  $2 \times 2$  matrix exists and equals

$$\begin{pmatrix} a & b \\ c & d \end{pmatrix}^{-1} = \frac{1}{ad - bc} \begin{pmatrix} d & -b \\ -c & a \end{pmatrix}$$

if and only if  $ad - bc \neq 0$ .

**PROOF** This computation is Exercise 21.

**QED**

We have seen here, as in the Mechanics of Matrix Multiplication subsection, that we can exploit the correspondence between linear maps and matrices. So we can fruitfully study both maps and matrices, translating back and forth to whichever helps the most.

Over this whole section we have developed an algebra system for matrices. We can compare it with the familiar algebra system for the real numbers. Here we are working not with numbers but with matrices. We have matrix addition and subtraction operations, and they work in much the same way as the real number operations, except that they only combine same-sized matrices. We have scalar multiplication, which is in some ways another extension of real number multiplication. We also have a matrix multiplication operation and a multiplicative inverse. These operations are somewhat like the familiar real number ones (associativity, and distributivity over addition, for example), but there are differences (failure of commutativity). This matrix system provides an example that algebra systems other than the elementary real number system can be interesting and useful.

### Exercises

4.12 Supply the intermediate steps in Example 4.9.

✓ 4.13 Use Corollary 4.11 to decide if each matrix has an inverse.

$$(a) \begin{pmatrix} 2 & 1 \\ -1 & 1 \end{pmatrix} \quad (b) \begin{pmatrix} 0 & 4 \\ 1 & -3 \end{pmatrix} \quad (c) \begin{pmatrix} 2 & -3 \\ -4 & 6 \end{pmatrix}$$

✓ 4.14 For each invertible matrix in the prior problem, use Corollary 4.11 to find its inverse.

✓ 4.15 Find the inverse, if it exists, by using the Gauss-Jordan method. Check the answers for the  $2 \times 2$  matrices with Corollary 4.11.

$$(a) \begin{pmatrix} 3 & 1 \\ 0 & 2 \end{pmatrix} \quad (b) \begin{pmatrix} 2 & 1/2 \\ 3 & 1 \end{pmatrix} \quad (c) \begin{pmatrix} 2 & -4 \\ -1 & 2 \end{pmatrix} \quad (d) \begin{pmatrix} 1 & 1 & 3 \\ 0 & 2 & 4 \\ -1 & 1 & 0 \end{pmatrix}$$

$$(e) \begin{pmatrix} 0 & 1 & 5 \\ 0 & -2 & 4 \\ 2 & 3 & -2 \end{pmatrix} \quad (f) \begin{pmatrix} 2 & 2 & 3 \\ 1 & -2 & -3 \\ 4 & -2 & -3 \end{pmatrix}$$

✓ 4.16 What matrix has this one for its inverse?

$$\begin{pmatrix} 1 & 3 \\ 2 & 5 \end{pmatrix}$$

- 4.17 How does the inverse operation interact with scalar multiplication and addition of matrices?
- (a) What is the inverse of  $rH$ ?
- (b) Is  $(H + G)^{-1} = H^{-1} + G^{-1}$ ?
- ✓ 4.18 Is  $(T^k)^{-1} = (T^{-1})^k$ ?
- 4.19 Is  $H^{-1}$  invertible?
- 4.20 For each real number  $\theta$  let  $t_\theta: \mathbb{R}^2 \rightarrow \mathbb{R}^2$  be represented with respect to the standard bases by this matrix.

$$\begin{pmatrix} \cos \theta & -\sin \theta \\ \sin \theta & \cos \theta \end{pmatrix}$$

Show that  $t_{\theta_1 + \theta_2} = t_{\theta_1} \cdot t_{\theta_2}$ . Show also that  $t_\theta^{-1} = t_{-\theta}$ .

- 4.21 Do the calculations for the proof of Corollary 4.11.
- 4.22 Show that this matrix
- $$H = \begin{pmatrix} 1 & 0 & 1 \\ 0 & 1 & 0 \end{pmatrix}$$
- has infinitely many right inverses. Show also that it has no left inverse.
- 4.23 In the review of inverses example, starting this subsection, how many left inverses has  $t$ ?
- 4.24 If a matrix has infinitely many right-inverses, can it have infinitely many left-inverses? Must it have?
- 4.25 Assume that  $g: V \rightarrow W$  is linear. One of these is true, the other is false. Which is which?
- (a) If  $f: W \rightarrow V$  is a left inverse of  $g$  then  $f$  must be linear.
- (b) If  $f: W \rightarrow V$  is a right inverse of  $g$  then  $f$  must be linear.
- ✓ 4.26 Assume that  $H$  is invertible and that  $HG$  is the zero matrix. Show that  $G$  is a zero matrix.
- 4.27 Prove that if  $H$  is invertible then the inverse commutes with a matrix  $GH^{-1} = H^{-1}G$  if and only if  $H$  itself commutes with that matrix  $GH = HG$ .
- ✓ 4.28 Show that if  $T$  is square and if  $T^4$  is the zero matrix then  $(I - T)^{-1} = I + T + T^2 + T^3$ . Generalize.
- ✓ 4.29 Let  $D$  be diagonal. Describe  $D^2, D^3, \dots$ , etc. Describe  $D^{-1}, D^{-2}, \dots$ , etc. Define  $D^0$  appropriately.
- 4.30 Prove that any matrix row-equivalent to an invertible matrix is also invertible.
- 4.31 *The first question below appeared as Exercise 29.*
- (a) Show that the rank of the product of two matrices is less than or equal to the minimum of the rank of each.
- (b) Show that if  $T$  and  $S$  are square then  $TS = I$  if and only if  $ST = I$ .
- 4.32 Show that the inverse of a permutation matrix is its transpose.
- 4.33 *The first two parts of this question appeared as Exercise 26.*
- (a) Show that  $(GH)^{\text{trans}} = H^{\text{trans}}G^{\text{trans}}$ .
- (b) A square matrix is *symmetric* if each  $i, j$  entry equals the  $j, i$  entry (that is, if the matrix equals its transpose). Show that the matrices  $HH^{\text{trans}}$  and  $H^{\text{trans}}H$  are symmetric.
- (c) Show that the inverse of the transpose is the transpose of the inverse.
- (d) Show that the inverse of a symmetric matrix is symmetric.
- ✓ 4.34 *The items starting this question appeared as Exercise 31.*
- (a) Prove that the composition of the projections  $\pi_x, \pi_y: \mathbb{R}^3 \rightarrow \mathbb{R}^3$  is the zero map despite that neither is the zero map.

(b) Prove that the composition of the derivatives  $d^2/dx^2, d^3/dx^3: \mathcal{P}_4 \rightarrow \mathcal{P}_4$  is the zero map despite that neither map is the zero map.

(c) Give matrix equations representing each of the prior two items.

When two things multiply to give zero despite that neither is zero, each is said to be a *zero divisor*. Prove that no zero divisor is invertible.

4.35 In real number algebra, there are exactly two numbers, 1 and  $-1$ , that are their own multiplicative inverse. Does  $H^2 = I$  have exactly two solutions for  $2 \times 2$  matrices?

4.36 Is the relation 'is a two-sided inverse of' transitive? Reflexive? Symmetric?

4.37 [Am. Math. Mon., Nov. 1951] Prove: if the sum of the elements of a square matrix is  $k$ , then the sum of the elements in each row of the inverse matrix is  $1/k$ .



## V Change of Basis

Representations vary with the bases. For instance,  $\vec{e}_1 \in \mathbb{R}^2$  has two different representations

$$\text{Rep}_{\mathcal{E}_2}(\vec{e}_1) = \begin{pmatrix} 1 \\ 0 \end{pmatrix} \quad \text{Rep}_B(\vec{e}_1) = \begin{pmatrix} 1/2 \\ 1/2 \end{pmatrix}$$

with respect to the standard basis and this one.

$$B = \left\langle \begin{pmatrix} 1 \\ 1 \end{pmatrix}, \begin{pmatrix} 1 \\ -1 \end{pmatrix} \right\rangle$$

The same is true for maps; with respect to the basis pairs  $\mathcal{E}_2, \mathcal{E}_2$  and  $\mathcal{E}_2, B$ , the identity map has two different representations.

$$\text{Rep}_{\mathcal{E}_2, \mathcal{E}_2}(\text{id}) = \begin{pmatrix} 1 & 0 \\ 0 & 1 \end{pmatrix} \quad \text{Rep}_{\mathcal{E}_2, B}(\text{id}) = \begin{pmatrix} 1/2 & 1/2 \\ 1/2 & -1/2 \end{pmatrix}$$

With our point of view that the objects of our studies are vectors and maps, by fixing bases we are adopting a scheme of tags or names for these objects that are convenient for calculations. We will now see how to translate among these names, so we will see exactly how the representations vary as the bases vary.

### V.1 Changing Representations of Vectors

In converting  $\text{Rep}_B(\vec{v})$  to  $\text{Rep}_D(\vec{v})$  the underlying vector  $\vec{v}$  doesn't change. Thus, this translation is accomplished by the identity map on the space, described so that the domain space vectors are represented with respect to  $B$  and the codomain space vectors are represented with respect to  $D$ .

$$\begin{array}{c} V_{\text{wrt } B} \\ \text{id} \downarrow \\ V_{\text{wrt } D} \end{array}$$

(The diagram is vertical to fit with the ones in the next subsection.)

**1.1 Definition** The *change of basis matrix* for bases  $B, D \subset V$  is the representation of the identity map  $\text{id}: V \rightarrow V$  with respect to those bases.

$$\text{Rep}_{B,D}(\text{id}) = \left( \begin{array}{c|ccc|c} \vdots & & & & \vdots \\ \text{Rep}_D(\vec{\beta}_1) & & \cdots & & \text{Rep}_D(\vec{\beta}_n) \\ \vdots & & & & \vdots \end{array} \right)$$

**1.2 Lemma** Left-multiplication by the change of basis matrix for  $B, D$  converts a representation with respect to  $B$  to one with respect to  $D$ . Conversely, if left-multiplication by a matrix changes bases  $M \cdot \text{Rep}_B(\vec{v}) = \text{Rep}_D(\vec{v})$  then  $M$  is a change of basis matrix.

**PROOF** For the first sentence, because matrix-vector multiplication represents a map application  $\text{Rep}_{B,D}(\text{id}) \cdot \text{Rep}_B(\vec{v}) = \text{Rep}_D(\text{id}(\vec{v})) = \text{Rep}_D(\vec{v})$  for each  $\vec{v}$ . For the second, with respect to  $B, D$  the matrix  $M$  represents a linear map whose action is to map each vector to itself, and is therefore the identity map. QED

**1.3 Example** With these bases for  $\mathbb{R}^2$ ,

$$B = \left\langle \begin{pmatrix} 2 \\ 1 \end{pmatrix}, \begin{pmatrix} 1 \\ 0 \end{pmatrix} \right\rangle \quad D = \left\langle \begin{pmatrix} -1 \\ 1 \end{pmatrix}, \begin{pmatrix} 1 \\ 1 \end{pmatrix} \right\rangle$$

because

$$\text{Rep}_D(\text{id}\left(\begin{pmatrix} 2 \\ 1 \end{pmatrix}\right)) = \begin{pmatrix} -1/2 \\ 3/2 \end{pmatrix}_D \quad \text{Rep}_D(\text{id}\left(\begin{pmatrix} 1 \\ 0 \end{pmatrix}\right)) = \begin{pmatrix} -1/2 \\ 1/2 \end{pmatrix}_D$$

the change of basis matrix is this.

$$\text{Rep}_{B,D}(\text{id}) = \begin{pmatrix} -1/2 & -1/2 \\ 3/2 & 1/2 \end{pmatrix}$$

For instance, if we find the representations of  $\vec{e}_2$

$$\text{Rep}_B\left(\begin{pmatrix} 0 \\ 1 \end{pmatrix}\right) = \begin{pmatrix} 1 \\ -2 \end{pmatrix} \quad \text{Rep}_D\left(\begin{pmatrix} 0 \\ 1 \end{pmatrix}\right) = \begin{pmatrix} 1/2 \\ 1/2 \end{pmatrix}$$

then the matrix will do the conversion.

$$\begin{pmatrix} -1/2 & -1/2 \\ 3/2 & 1/2 \end{pmatrix} \begin{pmatrix} 1 \\ -2 \end{pmatrix} = \begin{pmatrix} 1/2 \\ 1/2 \end{pmatrix}$$

We finish this subsection by recognizing that the change of basis matrices form a familiar set.

**1.4 Lemma** A matrix changes bases if and only if it is nonsingular.

**PROOF** For the ‘only if’ direction, if left-multiplication by a matrix changes bases then the matrix represents an invertible function, simply because we can invert the function by changing the bases back. Such a matrix is itself invertible, and so is nonsingular.

To finish we will show that any nonsingular matrix  $M$  performs a change of basis operation from any given starting basis  $B$  to some ending basis. Because the matrix is nonsingular it will Gauss-Jordan reduce to the identity. If the matrix is the identity  $I$  then the statement is obvious. Otherwise there are elementary

reduction matrices such that  $R_r \cdots R_1 \cdot M = I$  with  $r \geq 1$ . Elementary matrices are invertible and their inverses are also elementary so multiplying both sides of that equation from the left by  $R_r^{-1}$ , then by  $R_{r-1}^{-1}$ , etc., gives  $M$  as a product of elementary matrices  $M = R_1^{-1} \cdots R_r^{-1}$ . (We've combined  $R_r^{-1}I$  to make  $R_r^{-1}$ ; because  $r \geq 1$  we can always make the  $I$  disappear in this way, which we need to do because it isn't an elementary matrix.)

Thus, we will be done if we show that elementary matrices change a given basis to another basis, for then  $R_r^{-1}$  changes  $B$  to some other basis  $B_r$ , and  $R_{r-1}^{-1}$  changes  $B_r$  to some  $B_{r-1}$ , etc., and the net effect is that  $M$  changes  $B$  to  $B_1$ . We will prove this by covering the three types of elementary matrices separately; here are the three cases.

$$M_i(k) \begin{pmatrix} c_1 \\ \vdots \\ c_i \\ \vdots \\ c_n \end{pmatrix} = \begin{pmatrix} c_1 \\ \vdots \\ kc_i \\ \vdots \\ c_n \end{pmatrix} \quad P_{i,j} \begin{pmatrix} c_1 \\ \vdots \\ c_i \\ \vdots \\ c_j \\ \vdots \\ c_n \end{pmatrix} = \begin{pmatrix} c_1 \\ \vdots \\ c_j \\ \vdots \\ c_i \\ \vdots \\ c_n \end{pmatrix} \quad C_{i,j}(k) \begin{pmatrix} c_1 \\ \vdots \\ c_i \\ \vdots \\ c_j \\ \vdots \\ c_n \end{pmatrix} = \begin{pmatrix} c_1 \\ \vdots \\ c_i \\ \vdots \\ kc_i + c_j \\ \vdots \\ c_n \end{pmatrix}$$

Applying a row-multiplication matrix changes a representation with respect to  $\langle \vec{\beta}_1, \dots, \vec{\beta}_i, \dots, \vec{\beta}_n \rangle$  to one with respect to  $\langle \vec{\beta}_1, \dots, (1/k)\vec{\beta}_i, \dots, \vec{\beta}_n \rangle$ .

$$\begin{aligned} \vec{v} &= c_1 \cdot \vec{\beta}_1 + \cdots + c_i \cdot \vec{\beta}_i + \cdots + c_n \cdot \vec{\beta}_n \\ &\mapsto c_1 \cdot \vec{\beta}_1 + \cdots + kc_i \cdot (1/k)\vec{\beta}_i + \cdots + c_n \cdot \vec{\beta}_n = \vec{v} \end{aligned}$$

We can easily see that the second one is a basis, given that the first is a basis and that  $k \neq 0$  is a restriction in the definition of a row-multiplication matrix. Similarly, left-multiplication by a row-swap matrix  $P_{i,j}$  changes a representation with respect to the basis  $\langle \vec{\beta}_1, \dots, \vec{\beta}_i, \dots, \vec{\beta}_j, \dots, \vec{\beta}_n \rangle$  into one with respect to this basis  $\langle \vec{\beta}_1, \dots, \vec{\beta}_j, \dots, \vec{\beta}_i, \dots, \vec{\beta}_n \rangle$ .

$$\begin{aligned} \vec{v} &= c_1 \cdot \vec{\beta}_1 + \cdots + c_i \cdot \vec{\beta}_i + \cdots + c_j \vec{\beta}_j + \cdots + c_n \cdot \vec{\beta}_n \\ &\mapsto c_1 \cdot \vec{\beta}_1 + \cdots + c_j \cdot \vec{\beta}_j + \cdots + c_i \cdot \vec{\beta}_i + \cdots + c_n \cdot \vec{\beta}_n = \vec{v} \end{aligned}$$

And, a representation with respect to  $\langle \vec{\beta}_1, \dots, \vec{\beta}_i, \dots, \vec{\beta}_j, \dots, \vec{\beta}_n \rangle$  changes via left-multiplication by a row-combination matrix  $C_{i,j}(k)$  into a representation with respect to  $\langle \vec{\beta}_1, \dots, \vec{\beta}_i - k\vec{\beta}_j, \dots, \vec{\beta}_j, \dots, \vec{\beta}_n \rangle$

$$\begin{aligned} \vec{v} &= c_1 \cdot \vec{\beta}_1 + \cdots + c_i \cdot \vec{\beta}_i + c_j \vec{\beta}_j + \cdots + c_n \cdot \vec{\beta}_n \\ &\mapsto c_1 \cdot \vec{\beta}_1 + \cdots + c_i \cdot (\vec{\beta}_i - k\vec{\beta}_j) + \cdots + (kc_i + c_j) \cdot \vec{\beta}_j + \cdots + c_n \cdot \vec{\beta}_n = \vec{v} \end{aligned}$$

(the definition of reduction matrices specifies that  $i \neq j$  and  $k \neq 0$ ). QED

**1.5 Corollary** A matrix is nonsingular if and only if it represents the identity map with respect to some pair of bases.

In the next subsection we will see how to translate among representations of maps, that is, how to change  $\text{Rep}_{B,D}(h)$  to  $\text{Rep}_{\hat{B},\hat{D}}(h)$ . The above corollary is a special case of this, where the domain and range are the same space, and where the map is the identity map.

### Exercises

✓ **1.6** In  $\mathbb{R}^2$ , where

$$D = \left\langle \begin{pmatrix} 2 \\ 1 \end{pmatrix}, \begin{pmatrix} -2 \\ 4 \end{pmatrix} \right\rangle$$

find the change of basis matrices from  $D$  to  $\mathcal{E}_2$  and from  $\mathcal{E}_2$  to  $D$ . Multiply the two.

✓ **1.7** Find the change of basis matrix for  $B, D \subseteq \mathbb{R}^2$ .

(a)  $B = \mathcal{E}_2, D = \langle \vec{e}_2, \vec{e}_1 \rangle$     (b)  $B = \mathcal{E}_2, D = \left\langle \begin{pmatrix} 1 \\ 2 \end{pmatrix}, \begin{pmatrix} 1 \\ 4 \end{pmatrix} \right\rangle$

(c)  $B = \left\langle \begin{pmatrix} 1 \\ 2 \end{pmatrix}, \begin{pmatrix} 1 \\ 4 \end{pmatrix} \right\rangle, D = \mathcal{E}_2$     (d)  $B = \left\langle \begin{pmatrix} -1 \\ 1 \end{pmatrix}, \begin{pmatrix} 2 \\ 2 \end{pmatrix} \right\rangle, D = \left\langle \begin{pmatrix} 0 \\ 4 \end{pmatrix}, \begin{pmatrix} 1 \\ 3 \end{pmatrix} \right\rangle$

**1.8** For the bases in Exercise 7, find the change of basis matrix in the other direction, from  $D$  to  $B$ .

✓ **1.9** Find the change of basis matrix for each  $B, D \subseteq \mathcal{P}_2$ .

(a)  $B = \langle 1, x, x^2 \rangle, D = \langle x^2, 1, x \rangle$     (b)  $B = \langle 1, x, x^2 \rangle, D = \langle 1, 1+x, 1+x+x^2 \rangle$   
 (c)  $B = \langle 2, 2x, x^2 \rangle, D = \langle 1+x^2, 1-x^2, x+x^2 \rangle$

✓ **1.10** Decide if each changes bases on  $\mathbb{R}^2$ . To what basis is  $\mathcal{E}_2$  changed?

(a)  $\begin{pmatrix} 5 & 0 \\ 0 & 4 \end{pmatrix}$     (b)  $\begin{pmatrix} 2 & 1 \\ 3 & 1 \end{pmatrix}$     (c)  $\begin{pmatrix} -1 & 4 \\ 2 & -8 \end{pmatrix}$     (d)  $\begin{pmatrix} 1 & -1 \\ 1 & 1 \end{pmatrix}$

**1.11** Find bases such that this matrix represents the identity map with respect to those bases.

$$\begin{pmatrix} 3 & 1 & 4 \\ 2 & -1 & 1 \\ 0 & 0 & 4 \end{pmatrix}$$

**1.12** Consider the vector space of real-valued functions with basis  $\langle \sin(x), \cos(x) \rangle$ . Show that  $\langle 2\sin(x) + \cos(x), 3\cos(x) \rangle$  is also a basis for this space. Find the change of basis matrix in each direction.

**1.13** Where does this matrix

$$\begin{pmatrix} \cos(2\theta) & \sin(2\theta) \\ \sin(2\theta) & -\cos(2\theta) \end{pmatrix}$$

send the standard basis for  $\mathbb{R}^2$ ? Any other bases? *Hint.* Consider the inverse.

✓ **1.14** What is the change of basis matrix with respect to  $B, B$ ?

**1.15** Prove that a matrix changes bases if and only if it is invertible.

**1.16** Finish the proof of Lemma 1.4.

✓ **1.17** Let  $H$  be a  $n \times n$  nonsingular matrix. What basis of  $\mathbb{R}^n$  does  $H$  change to the standard basis?

✓ **1.18** (a) In  $\mathcal{P}_3$  with basis  $B = \langle 1+x, 1-x, x^2+x^3, x^2-x^3 \rangle$  we have this representation.

$$\text{Rep}_B(1-x+3x^2-x^3) = \begin{pmatrix} 0 \\ 1 \\ 1 \\ 2 \end{pmatrix}_B$$

Find a basis  $D$  giving this different representation for the same polynomial.

$$\text{Rep}_D(1 - x + 3x^2 - x^3) = \begin{pmatrix} 1 \\ 0 \\ 2 \\ 0 \end{pmatrix}_D$$

(b) State and prove that we can change any nonzero vector representation to any other.

*Hint.* The proof of Lemma 1.4 is constructive—it not only says the bases change, it shows how they change.

1.19 Let  $V, W$  be vector spaces, and let  $B, \hat{B}$  be bases for  $V$  and  $D, \hat{D}$  be bases for  $W$ . Where  $h: V \rightarrow W$  is linear, find a formula relating  $\text{Rep}_{B,D}(h)$  to  $\text{Rep}_{\hat{B},\hat{D}}(h)$ .

✓ 1.20 Show that the columns of an  $n \times n$  change of basis matrix form a basis for  $\mathbb{R}^n$ . Do all bases appear in that way: can the vectors from any  $\mathbb{R}^n$  basis make the columns of a change of basis matrix?

✓ 1.21 Find a matrix having this effect.

$$\begin{pmatrix} 1 \\ 3 \end{pmatrix} \mapsto \begin{pmatrix} 4 \\ -1 \end{pmatrix}$$

That is, find a  $M$  that left-multiplies the starting vector to yield the ending vector. Is there a matrix having these two effects?

$$(a) \begin{pmatrix} 1 \\ 3 \end{pmatrix} \mapsto \begin{pmatrix} 1 \\ 1 \end{pmatrix} \quad \begin{pmatrix} 2 \\ -1 \end{pmatrix} \mapsto \begin{pmatrix} -1 \\ -1 \end{pmatrix} \quad (b) \begin{pmatrix} 1 \\ 3 \end{pmatrix} \mapsto \begin{pmatrix} 1 \\ 1 \end{pmatrix} \quad \begin{pmatrix} 2 \\ 6 \end{pmatrix} \mapsto \begin{pmatrix} -1 \\ -1 \end{pmatrix}$$

Give a necessary and sufficient condition for there to be a matrix such that  $\vec{v}_1 \mapsto \vec{w}_1$  and  $\vec{v}_2 \mapsto \vec{w}_2$ .

## V.2 Changing Map Representations

The first subsection shows how to convert the representation of a vector with respect to one basis to the representation of that same vector with respect to another basis. Here we will see how to convert the representation of a map with respect to one pair of bases to the representation of that map with respect to a different pair, how to change  $\text{Rep}_{B,D}(h)$  to  $\text{Rep}_{\hat{B},\hat{D}}(h)$ .

That is, we want the relationship between the matrices in this arrow diagram.

$$\begin{array}{ccc} V_{\text{wrt } B} & \xrightarrow[H]{h} & W_{\text{wrt } D} \\ \text{id} \downarrow & & \text{id} \downarrow \\ V_{\text{wrt } \hat{B}} & \xrightarrow[\hat{H}]{h} & W_{\text{wrt } \hat{D}} \end{array}$$

To move from the lower-left of this diagram to the lower-right we can either go straight over, or else up to  $V_B$  then over to  $W_D$  and then down. So we can calculate  $\hat{H} = \text{Rep}_{\hat{B},\hat{D}}(h)$  either by simply using  $\hat{B}$  and  $\hat{D}$ , or else by first changing bases with  $\text{Rep}_{\hat{B},B}(\text{id})$  then multiplying by  $H = \text{Rep}_{B,D}(h)$  and then changing bases with  $\text{Rep}_{D,\hat{D}}(\text{id})$ .

This equation summarizes.

$$\hat{H} = \text{Rep}_{\mathcal{D}, \mathcal{D}}(\text{id}) \cdot H \cdot \text{Rep}_{\mathcal{B}, \mathcal{B}}(\text{id}) \quad (*)$$

(To compare this equation with the sentence before it, remember to read the equation from right to left because we read function composition from right to left and matrix multiplication represents composition.)

**2.1 Example** The matrix

$$T = \begin{pmatrix} \cos(\pi/6) & -\sin(\pi/6) \\ \sin(\pi/6) & \cos(\pi/6) \end{pmatrix} = \begin{pmatrix} \sqrt{3}/2 & -1/2 \\ 1/2 & \sqrt{3}/2 \end{pmatrix}$$

represents, with respect to  $\mathcal{E}_2, \mathcal{E}_2$ , the transformation  $t: \mathbb{R}^2 \rightarrow \mathbb{R}^2$  that rotates vectors  $\pi/6$  radians counterclockwise.

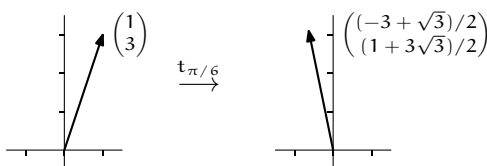

We can translate that to a representation with respect to

$$\hat{\mathcal{B}} = \left\langle \begin{pmatrix} 1 \\ 1 \end{pmatrix}, \begin{pmatrix} 0 \\ 2 \end{pmatrix} \right\rangle \quad \hat{\mathcal{D}} = \left\langle \begin{pmatrix} -1 \\ 0 \end{pmatrix}, \begin{pmatrix} 2 \\ 3 \end{pmatrix} \right\rangle$$

by using the arrow diagram and formula (\*) above.

$$\begin{array}{ccc} \mathbb{R}^2_{\text{wrt } \mathcal{E}_2} & \xrightarrow{T} & \mathbb{R}^2_{\text{wrt } \mathcal{E}_2} \\ \text{id} \downarrow & & \downarrow \text{id} \\ \mathbb{R}^2_{\text{wrt } \hat{\mathcal{B}}} & \xrightarrow{\hat{T}} & \mathbb{R}^2_{\text{wrt } \hat{\mathcal{D}}} \end{array} \quad \hat{T} = \text{Rep}_{\mathcal{E}_2, \hat{\mathcal{D}}}(\text{id}) \cdot T \cdot \text{Rep}_{\hat{\mathcal{B}}, \mathcal{E}_2}(\text{id})$$

Note that  $\text{Rep}_{\mathcal{E}_2, \hat{\mathcal{D}}}(\text{id})$  is the matrix inverse of  $\text{Rep}_{\hat{\mathcal{D}}, \mathcal{E}_2}(\text{id})$ .

$$\begin{aligned} \text{Rep}_{\hat{\mathcal{B}}, \hat{\mathcal{D}}}(t) &= \begin{pmatrix} -1 & 2 \\ 0 & 3 \end{pmatrix}^{-1} \begin{pmatrix} \sqrt{3}/2 & -1/2 \\ 1/2 & \sqrt{3}/2 \end{pmatrix} \begin{pmatrix} 1 & 0 \\ 1 & 2 \end{pmatrix} \\ &= \begin{pmatrix} (5 - \sqrt{3})/6 & (3 + 2\sqrt{3})/3 \\ (1 + \sqrt{3})/6 & \sqrt{3}/3 \end{pmatrix} \end{aligned}$$

Although the new matrix is messier, the map that it represents is the same. For instance, to replicate the effect of  $t$  in the picture, start with  $\hat{\mathcal{B}}$ ,

$$\text{Rep}_{\hat{\mathcal{B}}} \left( \begin{pmatrix} 1 \\ 3 \end{pmatrix} \right) = \begin{pmatrix} 1 \\ 1 \end{pmatrix}_{\hat{\mathcal{B}}}$$

apply  $\hat{T}$ ,

$$\begin{pmatrix} (5 - \sqrt{3})/6 & (3 + 2\sqrt{3})/3 \\ (1 + \sqrt{3})/6 & \sqrt{3}/3 \end{pmatrix}_{\hat{\mathcal{B}}, \hat{\mathcal{D}}} \begin{pmatrix} 1 \\ 1 \end{pmatrix}_{\hat{\mathcal{B}}} = \begin{pmatrix} (11 + 3\sqrt{3})/6 \\ (1 + 3\sqrt{3})/6 \end{pmatrix}_{\hat{\mathcal{D}}}$$

and check it against  $\hat{D}$

$$\frac{11 + 3\sqrt{3}}{6} \cdot \begin{pmatrix} -1 \\ 0 \end{pmatrix} + \frac{1 + 3\sqrt{3}}{6} \cdot \begin{pmatrix} 2 \\ 3 \end{pmatrix} = \begin{pmatrix} (-3 + \sqrt{3})/2 \\ (1 + 3\sqrt{3})/2 \end{pmatrix}$$

and it gives the same outcome as above.

**2.2 Example** We may make the matrix simpler by changing bases. On  $\mathbb{R}^3$  the map

$$\begin{pmatrix} x \\ y \\ z \end{pmatrix} \xrightarrow{t} \begin{pmatrix} y + z \\ x + z \\ x + y \end{pmatrix}$$

is represented with respect to the standard basis in this way.

$$\text{Rep}_{\mathcal{E}_3, \mathcal{E}_3}(t) = \begin{pmatrix} 0 & 1 & 1 \\ 1 & 0 & 1 \\ 1 & 1 & 0 \end{pmatrix}$$

Represented with respect to

$$B = \left\langle \begin{pmatrix} 1 \\ -1 \\ 0 \end{pmatrix}, \begin{pmatrix} 1 \\ 1 \\ -2 \end{pmatrix}, \begin{pmatrix} 1 \\ 1 \\ 1 \end{pmatrix} \right\rangle$$

gives a matrix that is diagonal.

$$\text{Rep}_{B, B}(t) = \begin{pmatrix} -1 & 0 & 0 \\ 0 & -1 & 0 \\ 0 & 0 & 2 \end{pmatrix}$$

Naturally we usually prefer basis changes that make the representation easier to understand. We say that a map or matrix has been *diagonalized* when its representation is diagonal with respect to  $B, B$ , that is, with respect to equal starting and ending bases. In Chapter Five we shall see which maps and matrices are diagonalizable. In the rest of this subsection we consider the easier case where representations are with respect to  $B, D$ , which are possibly different starting and ending bases. Recall that the prior subsection shows that a matrix changes bases if and only if it is nonsingular. That gives us another version of the above arrow diagram and equation (\*) from the start of this subsection.

**2.3 Definition** Same-sized matrices  $H$  and  $\hat{H}$  are *matrix equivalent* if there are nonsingular matrices  $P$  and  $Q$  such that  $\hat{H} = PHQ$ .

**2.4 Corollary** Matrix equivalent matrices represent the same map, with respect to appropriate pairs of bases.

Exercise 19 checks that matrix equivalence is an equivalence relation. Thus it partitions the set of matrices into matrix equivalence classes.



We can get some insight into the classes by comparing matrix equivalence with row equivalence (remember that matrices are row equivalent when they can be reduced to each other by row operations). In  $\hat{H} = PHQ$ , the matrices  $P$  and  $Q$  are nonsingular and thus we can write each as a product of elementary reduction matrices (Lemma 4.7). Left-multiplication by the reduction matrices making up  $P$  has the effect of performing row operations. Right-multiplication by the reduction matrices making up  $Q$  performs column operations. Therefore, matrix equivalence is a generalization of row equivalence—two matrices are row equivalent if one can be converted to the other by a sequence of row reduction steps, while two matrices are matrix equivalent if one can be converted to the other by a sequence of row reduction steps followed by a sequence of column reduction steps.

Thus, if matrices are row equivalent then they are also matrix equivalent (since we can take  $Q$  to be the identity matrix and so perform no column operations). The converse, however, does not hold: two matrices can be matrix equivalent but not row equivalent.

**2.5 Example** These two

$$\begin{pmatrix} 1 & 0 \\ 0 & 0 \end{pmatrix} \quad \begin{pmatrix} 1 & 1 \\ 0 & 0 \end{pmatrix}$$

are matrix equivalent because the second reduces to the first by the column operation of taking  $-1$  times the first column and adding to the second. They are not row equivalent because they have different reduced echelon forms (in fact, both are already in reduced form).

We will close this section by finding a set of representatives for the matrix equivalence classes.\*

**2.6 Theorem** Any  $m \times n$  matrix of rank  $k$  is matrix equivalent to the  $m \times n$  matrix that is all zeros except that the first  $k$  diagonal entries are ones.

$$\begin{pmatrix} 1 & 0 & \dots & 0 & 0 & \dots & 0 \\ 0 & 1 & \dots & 0 & 0 & \dots & 0 \\ \vdots & & & & & & \\ 0 & 0 & \dots & 1 & 0 & \dots & 0 \\ 0 & 0 & \dots & 0 & 0 & \dots & 0 \\ \vdots & & & & & & \\ 0 & 0 & \dots & 0 & 0 & \dots & 0 \end{pmatrix}$$

\* More information on class representatives is in the appendix.



This is a *block partial-identity* form.

$$\left( \begin{array}{c|c} I & Z \\ \hline Z & Z \end{array} \right)$$

**PROOF** As discussed above, Gauss-Jordan reduce the given matrix and combine all the reduction matrices used there to make P. Then use the leading entries to do column reduction and finish by swapping columns to put the leading ones on the diagonal. Combine the reduction matrices used for those column operations into Q. QED

**2.7 Example** We illustrate the proof by finding the P and Q for this matrix.

$$\begin{pmatrix} 1 & 2 & 1 & -1 \\ 0 & 0 & 1 & -1 \\ 2 & 4 & 2 & -2 \end{pmatrix}$$

First Gauss-Jordan row-reduce.

$$\begin{pmatrix} 1 & -1 & 0 \\ 0 & 1 & 0 \\ 0 & 0 & 1 \end{pmatrix} \begin{pmatrix} 1 & 0 & 0 \\ 0 & 1 & 0 \\ -2 & 0 & 1 \end{pmatrix} \begin{pmatrix} 1 & 2 & 1 & -1 \\ 0 & 0 & 1 & -1 \\ 2 & 4 & 2 & -2 \end{pmatrix} = \begin{pmatrix} 1 & 2 & 0 & 0 \\ 0 & 0 & 1 & -1 \\ 0 & 0 & 0 & 0 \end{pmatrix}$$

Then column-reduce, which involves right-multiplication.

$$\begin{pmatrix} 1 & 2 & 0 & 0 \\ 0 & 0 & 1 & -1 \\ 0 & 0 & 0 & 0 \end{pmatrix} \begin{pmatrix} 1 & -2 & 0 & 0 \\ 0 & 1 & 0 & 0 \\ 0 & 0 & 1 & 0 \\ 0 & 0 & 0 & 1 \end{pmatrix} \begin{pmatrix} 1 & 0 & 0 & 0 \\ 0 & 1 & 0 & 0 \\ 0 & 0 & 1 & 1 \\ 0 & 0 & 0 & 1 \end{pmatrix} = \begin{pmatrix} 1 & 0 & 0 & 0 \\ 0 & 0 & 1 & 0 \\ 0 & 0 & 0 & 0 \end{pmatrix}$$

Finish by swapping columns.

$$\begin{pmatrix} 1 & 0 & 0 & 0 \\ 0 & 0 & 1 & 0 \\ 0 & 0 & 0 & 0 \end{pmatrix} \begin{pmatrix} 1 & 0 & 0 & 0 \\ 0 & 0 & 1 & 0 \\ 0 & 1 & 0 & 0 \\ 0 & 0 & 0 & 1 \end{pmatrix} = \begin{pmatrix} 1 & 0 & 0 & 0 \\ 0 & 1 & 0 & 0 \\ 0 & 0 & 0 & 0 \end{pmatrix}$$

Finally, combine the left-multipliers together as P and the right-multipliers together as Q to get the PHQ equation.

$$\begin{pmatrix} 1 & -1 & 0 \\ 0 & 1 & 0 \\ -2 & 0 & 1 \end{pmatrix} \begin{pmatrix} 1 & 2 & 1 & -1 \\ 0 & 0 & 1 & -1 \\ 2 & 4 & 2 & -2 \end{pmatrix} \begin{pmatrix} 1 & 0 & -2 & 0 \\ 0 & 0 & 1 & 0 \\ 0 & 1 & 0 & 1 \\ 0 & 0 & 0 & 1 \end{pmatrix} = \begin{pmatrix} 1 & 0 & 0 & 0 \\ 0 & 1 & 0 & 0 \\ 0 & 0 & 0 & 0 \end{pmatrix}$$

**2.8 Corollary** Two same-sized matrices are matrix equivalent if and only if they have the same rank. That is, the matrix equivalence classes are characterized by rank.

**PROOF** Two same-sized matrices with the same rank are equivalent to the same block partial-identity matrix. QED

**2.9 Example** The  $2 \times 2$  matrices have only three possible ranks: zero, one, or two. Thus there are three matrix-equivalence classes.

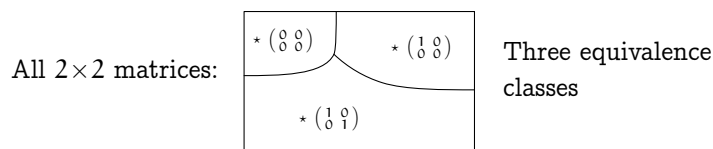

Each class consists of all of the  $2 \times 2$  matrices with the same rank. There is only one rank zero matrix so that class has only one member. The other two classes have infinitely many members.

In this subsection we have seen how to change the representation of a map with respect to a first pair of bases to one with respect to a second pair. That led to a definition describing when matrices are equivalent in this way. Finally we noted that, with the proper choice of (possibly different) starting and ending bases, any map can be represented in block partial-identity form.

One of the nice things about this representation is that, in some sense, we can completely understand the map when we express it in this way: if the bases are  $B = \langle \vec{\beta}_1, \dots, \vec{\beta}_n \rangle$  and  $D = \langle \vec{\delta}_1, \dots, \vec{\delta}_m \rangle$  then the map sends

$$c_1 \vec{\beta}_1 + \dots + c_k \vec{\beta}_k + c_{k+1} \vec{\beta}_{k+1} + \dots + c_n \vec{\beta}_n \mapsto c_1 \vec{\delta}_1 + \dots + c_k \vec{\delta}_k + \vec{0} + \dots + \vec{0}$$

where  $k$  is the map's rank. Thus, we can understand any linear map as a kind of projection.

$$\begin{pmatrix} c_1 \\ \vdots \\ c_k \\ c_{k+1} \\ \vdots \\ c_n \end{pmatrix}_B \mapsto \begin{pmatrix} c_1 \\ \vdots \\ c_k \\ 0 \\ \vdots \\ 0 \end{pmatrix}_D$$

Of course, "understanding" a map expressed in this way requires that we understand the relationship between  $B$  and  $D$ . Nonetheless, this is a good classification of linear maps.

### Exercises

✓ **2.10** Decide if these matrices are matrix equivalent.

(a)  $\begin{pmatrix} 1 & 3 & 0 \\ 2 & 3 & 0 \end{pmatrix}, \begin{pmatrix} 2 & 2 & 1 \\ 0 & 5 & -1 \end{pmatrix}$

(b)  $\begin{pmatrix} 0 & 3 \\ 1 & 1 \end{pmatrix}, \begin{pmatrix} 4 & 0 \\ 0 & 5 \end{pmatrix}$

(c)  $\begin{pmatrix} 1 & 3 \\ 2 & 6 \end{pmatrix}, \begin{pmatrix} 1 & 3 \\ 2 & -6 \end{pmatrix}$

✓ **2.11** Find the canonical representative of the matrix-equivalence class of each matrix.

$$(a) \begin{pmatrix} 2 & 1 & 0 \\ 4 & 2 & 0 \end{pmatrix} \quad (b) \begin{pmatrix} 0 & 1 & 0 & 2 \\ 1 & 1 & 0 & 4 \\ 3 & 3 & 3 & -1 \end{pmatrix}$$

2.12 Suppose that, with respect to

$$B = \mathcal{E}_2 \quad D = \left\langle \begin{pmatrix} 1 \\ 1 \end{pmatrix}, \begin{pmatrix} 1 \\ -1 \end{pmatrix} \right\rangle$$

the transformation  $t: \mathbb{R}^2 \rightarrow \mathbb{R}^2$  is represented by this matrix.

$$\begin{pmatrix} 1 & 2 \\ 3 & 4 \end{pmatrix}$$

Use change of basis matrices to represent  $t$  with respect to each pair.

$$(a) \hat{B} = \left\langle \begin{pmatrix} 0 \\ 1 \end{pmatrix}, \begin{pmatrix} 1 \\ 1 \end{pmatrix} \right\rangle, \hat{D} = \left\langle \begin{pmatrix} -1 \\ 0 \end{pmatrix}, \begin{pmatrix} 2 \\ 1 \end{pmatrix} \right\rangle$$

$$(b) \hat{B} = \left\langle \begin{pmatrix} 1 \\ 2 \end{pmatrix}, \begin{pmatrix} 1 \\ 0 \end{pmatrix} \right\rangle, \hat{D} = \left\langle \begin{pmatrix} 1 \\ 2 \end{pmatrix}, \begin{pmatrix} 2 \\ 1 \end{pmatrix} \right\rangle$$

- ✓ 2.13 What sizes are  $P$  and  $Q$  in the equation  $\hat{H} = PHQ$ ?
- ✓ 2.14 Use Theorem 2.6 to show that a square matrix is nonsingular if and only if it is equivalent to an identity matrix.
- ✓ 2.15 Show that, where  $A$  is a nonsingular square matrix, if  $P$  and  $Q$  are nonsingular square matrices such that  $PAQ = I$  then  $QP = A^{-1}$ .
- ✓ 2.16 Why does Theorem 2.6 not show that every matrix is diagonalizable (see Example 2.2)?
- 2.17 Must matrix equivalent matrices have matrix equivalent transposes?
- 2.18 What happens in Theorem 2.6 if  $k = 0$ ?
- ✓ 2.19 Show that matrix-equivalence is an equivalence relation.
- ✓ 2.20 Show that a zero matrix is alone in its matrix equivalence class. Are there other matrices like that?
- 2.21 What are the matrix equivalence classes of matrices of transformations on  $\mathbb{R}^1$ ?  $\mathbb{R}^3$ ?
- 2.22 How many matrix equivalence classes are there?
- 2.23 Are matrix equivalence classes closed under scalar multiplication? Addition?
- 2.24 Let  $t: \mathbb{R}^n \rightarrow \mathbb{R}^n$  represented by  $T$  with respect to  $\mathcal{E}_n, \mathcal{E}_n$ .
  - (a) Find  $\text{Rep}_{B,B}(t)$  in this specific case.

$$T = \begin{pmatrix} 1 & 1 \\ 3 & -1 \end{pmatrix} \quad B = \left\langle \begin{pmatrix} 1 \\ 2 \end{pmatrix}, \begin{pmatrix} -1 \\ -1 \end{pmatrix} \right\rangle$$

- (b) Describe  $\text{Rep}_{B,B}(t)$  in the general case where  $B = \langle \vec{\beta}_1, \dots, \vec{\beta}_n \rangle$ .
- 2.25 (a) Let  $V$  have bases  $B_1$  and  $B_2$  and suppose that  $W$  has the basis  $D$ . Where  $h: V \rightarrow W$ , find the formula that computes  $\text{Rep}_{B_2,D}(h)$  from  $\text{Rep}_{B_1,D}(h)$ .
  - (b) Repeat the prior question with one basis for  $V$  and two bases for  $W$ .
- 2.26 (a) If two matrices are matrix-equivalent and invertible, must their inverses be matrix-equivalent?
  - (b) If two matrices have matrix-equivalent inverses, must the two be matrix-equivalent?
  - (c) If two matrices are square and matrix-equivalent, must their squares be matrix-equivalent?
  - (d) If two matrices are square and have matrix-equivalent squares, must they be matrix-equivalent?

- ✓ 2.27 Square matrices are *similar* if they represent the same transformation, but each with respect to the same ending as starting basis. That is,  $\text{Rep}_{B_1, B_1}(t)$  is similar to  $\text{Rep}_{B_2, B_2}(t)$ .
- Give a definition of matrix similarity like that of Definition 2.3.
  - Prove that similar matrices are matrix equivalent.
  - Show that similarity is an equivalence relation.
  - Show that if  $T$  is similar to  $\hat{T}$  then  $T^2$  is similar to  $\hat{T}^2$ , the cubes are similar, etc. *Contrast with the prior exercise.*
  - Prove that there are matrix equivalent matrices that are not similar.

## VI Projection

*This section is optional. It is only required for the last two sections of Chapter Five.*

We have described the projection  $\pi$  from  $\mathbb{R}^3$  into its  $xy$ -plane subspace as a ‘shadow map’. This shows why, but it also shows that some shadows fall upward.

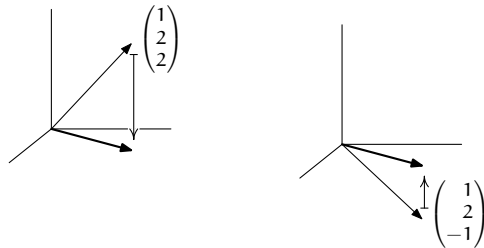

So perhaps a better description is: the projection of  $\vec{v}$  is the  $\vec{p}$  in the plane with the property that someone standing on  $\vec{p}$  and looking directly up or down sees  $\vec{v}$ . In this section we will generalize this to other projections, both orthogonal and non-orthogonal.

### VI.1 Orthogonal Projection Into a Line

We first consider orthogonal projection of a vector  $\vec{v}$  into a line  $\ell$ . This picture shows someone walking out on the line until they are at a point  $\vec{p}$  such that the tip of  $\vec{v}$  is directly overhead, where their line of sight is not parallel to the  $y$ -axis but is instead orthogonal to the line.

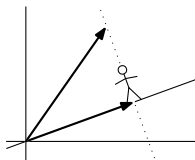

Since we can describe the line as the span of some vector  $\ell = \{c \cdot \vec{s} \mid c \in \mathbb{R}\}$ , this person has found the coefficient  $c_{\vec{p}}$  with the property that  $\vec{v} - c_{\vec{p}} \vec{s}$  is orthogonal to  $c_{\vec{p}} \vec{s}$ .

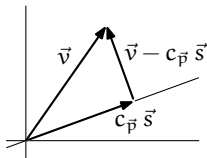

To solve for this coefficient, observe that because  $\vec{v} - c_{\vec{p}} \vec{s}$  is orthogonal to a scalar multiple of  $\vec{s}$ , it must be orthogonal to  $\vec{s}$  itself. Then  $(\vec{v} - c_{\vec{p}} \vec{s}) \cdot \vec{s} = 0$  gives that  $c_{\vec{p}} = \vec{v} \cdot \vec{s} / \vec{s} \cdot \vec{s}$ .

**1.1 Definition** The orthogonal projection of  $\vec{v}$  into the line spanned by a nonzero  $\vec{s}$  is this vector.

$$\text{proj}_{[\vec{s}]}(\vec{v}) = \frac{\vec{v} \cdot \vec{s}}{\vec{s} \cdot \vec{s}} \cdot \vec{s}$$

**1.2 Remark** That definition says ‘spanned by  $\vec{s}$ ’ instead the more formal ‘the span of the set  $\{\vec{s}\}$ ’. This more casual phrase is common.

**1.3 Example** To orthogonally project the vector  $\begin{pmatrix} 2 \\ 3 \end{pmatrix}$  into the line  $y = 2x$ , we first pick a direction vector for the line.

$$\vec{s} = \begin{pmatrix} 1 \\ 2 \end{pmatrix}$$

The calculation is easy.

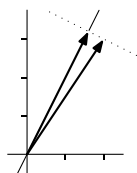

$$\frac{\begin{pmatrix} 2 \\ 3 \end{pmatrix} \cdot \begin{pmatrix} 1 \\ 2 \end{pmatrix}}{\begin{pmatrix} 1 \\ 2 \end{pmatrix} \cdot \begin{pmatrix} 1 \\ 2 \end{pmatrix}} \cdot \begin{pmatrix} 1 \\ 2 \end{pmatrix} = \frac{8}{5} \cdot \begin{pmatrix} 1 \\ 2 \end{pmatrix} = \begin{pmatrix} 8/5 \\ 16/5 \end{pmatrix}$$

**1.4 Example** In  $\mathbb{R}^3$ , the orthogonal projection of a general vector

$$\begin{pmatrix} x \\ y \\ z \end{pmatrix}$$

into the  $y$ -axis is

$$\frac{\begin{pmatrix} x \\ y \\ z \end{pmatrix} \cdot \begin{pmatrix} 0 \\ 1 \\ 0 \end{pmatrix}}{\begin{pmatrix} 0 \\ 1 \\ 0 \end{pmatrix} \cdot \begin{pmatrix} 0 \\ 1 \\ 0 \end{pmatrix}} \cdot \begin{pmatrix} 0 \\ 1 \\ 0 \end{pmatrix} = \begin{pmatrix} 0 \\ y \\ 0 \end{pmatrix}$$

which matches our intuitive expectation.

The picture above with the stick figure walking out on the line until  $\vec{v}$ 's tip is overhead is one way to think of the orthogonal projection of a vector into a line. We finish this subsection with two other ways.

**1.5 Example** A railroad car left on an east-west track without its brake is pushed by a wind blowing toward the northeast at fifteen miles per hour; what speed will the car reach?

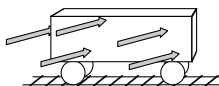

For the wind we use a vector of length 15 that points toward the northeast.

$$\vec{v} = \begin{pmatrix} 15\sqrt{1/2} \\ 15\sqrt{1/2} \end{pmatrix}$$

The car is only affected by the part of the wind blowing in the east-west direction—the part of  $\vec{v}$  in the direction of the  $x$ -axis is this (the picture has the same perspective as the railroad car picture above).



So the car will reach a velocity of  $15\sqrt{1/2}$  miles per hour toward the east.

Thus, another way to think of the picture that precedes the definition is that it shows  $\vec{v}$  as decomposed into two parts, the part  $\vec{p}$  with the line, and the part that is orthogonal to the line (shown above on the north-south axis). These two are non-interacting in the sense that the east-west car is not at all affected by the north-south part of the wind (see Exercise 11). So we can think of the orthogonal projection of  $\vec{v}$  into the line spanned by  $\vec{s}$  as the part of  $\vec{v}$  that lies in the direction of  $\vec{s}$ .

Still another useful way to think of orthogonal projection is to have the person stand not on the line but on the vector. This person holds a rope with a loop over the line  $\ell$ .

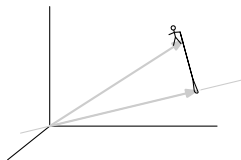

When they pull the rope tight, the loop slides on  $\ell$  until the rope is orthogonal to that line. That is, we can think of the projection  $\vec{p}$  as being the vector in the line that is closest to  $\vec{v}$  (see Exercise 17).

**1.6 Example** A submarine is tracking a ship moving along the line  $y = 3x + 2$ . Torpedo range is one-half mile. If the sub stays where it is, at the origin on the chart below, will the ship pass within range?

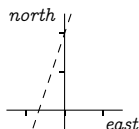

The formula for projection into a line does not immediately apply because the line doesn't pass through the origin, and so isn't the span of any  $\vec{s}$ . To adjust for this, we start by shifting the entire map down two units. Now the line is  $y = 3x$ , a subspace. We project to get the point  $\vec{p}$  on the line closest to

$$\vec{v} = \begin{pmatrix} 0 \\ -2 \end{pmatrix}$$

the sub's shifted position.

$$\vec{p} = \frac{\begin{pmatrix} 0 \\ -2 \end{pmatrix} \cdot \begin{pmatrix} 1 \\ 3 \end{pmatrix}}{\begin{pmatrix} 1 \\ 3 \end{pmatrix} \cdot \begin{pmatrix} 1 \\ 3 \end{pmatrix}} \cdot \begin{pmatrix} 1 \\ 3 \end{pmatrix} = \begin{pmatrix} -3/5 \\ -9/5 \end{pmatrix}$$

The distance between  $\vec{v}$  and  $\vec{p}$  is about 0.63 miles. The ship will not be in range.

This subsection has developed a natural projection map, orthogonal projection into a line. As suggested by the examples, we use it often in applications. The next subsection shows how the definition of orthogonal projection into a line gives us a way to calculate especially convenient bases for vector spaces, again something that we often see in applications. The final subsection completely generalizes projection, orthogonal or not, into any subspace at all.

### Exercises

- ✓ **1.7** Project the first vector orthogonally into the line spanned by the second vector.

(a)  $\begin{pmatrix} 2 \\ 1 \end{pmatrix}, \begin{pmatrix} 3 \\ -2 \end{pmatrix}$    (b)  $\begin{pmatrix} 2 \\ 1 \end{pmatrix}, \begin{pmatrix} 3 \\ 0 \end{pmatrix}$    (c)  $\begin{pmatrix} 1 \\ 1 \\ 4 \end{pmatrix}, \begin{pmatrix} 1 \\ 2 \\ -1 \end{pmatrix}$    (d)  $\begin{pmatrix} 1 \\ 1 \\ 4 \end{pmatrix}, \begin{pmatrix} 3 \\ 3 \\ 12 \end{pmatrix}$

- ✓ **1.8** Project the vector orthogonally into the line.

(a)  $\begin{pmatrix} 2 \\ -1 \\ 4 \end{pmatrix}, \{c \begin{pmatrix} -3 \\ 1 \\ -3 \end{pmatrix} \mid c \in \mathbb{R}\}$    (b)  $\begin{pmatrix} -1 \\ -1 \end{pmatrix}, \text{ the line } y = 3x$

- 1.9** Although pictures guided our development of Definition 1.1, we are not restricted to spaces that we can draw. In  $\mathbb{R}^4$  project this vector into this line.

$$\vec{v} = \begin{pmatrix} 1 \\ 2 \\ 1 \\ 3 \end{pmatrix} \quad \ell = \left\{ c \cdot \begin{pmatrix} -1 \\ 1 \\ -1 \\ 1 \end{pmatrix} \mid c \in \mathbb{R} \right\}$$

- ✓ **1.10** Definition 1.1 uses two vectors  $\vec{s}$  and  $\vec{v}$ . Consider the transformation of  $\mathbb{R}^2$  resulting from fixing

$$\vec{s} = \begin{pmatrix} 3 \\ 1 \end{pmatrix}$$

and projecting  $\vec{v}$  into the line that is the span of  $\vec{s}$ . Apply it to these vectors.

(a)  $\begin{pmatrix} 1 \\ 2 \end{pmatrix}$    (b)  $\begin{pmatrix} 0 \\ 4 \end{pmatrix}$

Show that in general the projection transformation is this.

$$\begin{pmatrix} x_1 \\ x_2 \end{pmatrix} \mapsto \begin{pmatrix} (x_1 + 3x_2)/10 \\ (3x_1 + 9x_2)/10 \end{pmatrix}$$

Express the action of this transformation with a matrix.

- 1.11** Example 1.5 suggests that projection breaks  $\vec{v}$  into two parts,  $\text{proj}_{[\vec{s}]}(\vec{v})$  and  $\vec{v} - \text{proj}_{[\vec{s}]}(\vec{v})$ , that are non-interacting. Recall that the two are orthogonal. Show that any two nonzero orthogonal vectors make up a linearly independent set.

- 1.12** (a) What is the orthogonal projection of  $\vec{v}$  into a line if  $\vec{v}$  is a member of that line?



- (b) Show that if  $\vec{v}$  is not a member of the line then the set  $\{\vec{v}, \vec{v} - \text{proj}_{[\vec{s}]}(\vec{v})\}$  is linearly independent.
- 1.13 Definition 1.1 requires that  $\vec{s}$  be nonzero. Why? What is the right definition of the orthogonal projection of a vector into the (degenerate) line spanned by the zero vector?
- 1.14 Are all vectors the projection of some other vector into some line?
- ✓ 1.15 Show that the projection of  $\vec{v}$  into the line spanned by  $\vec{s}$  has length equal to the absolute value of the number  $\vec{v} \cdot \vec{s}$  divided by the length of the vector  $\vec{s}$ .
- 1.16 Find the formula for the distance from a point to a line.
- 1.17 Find the scalar  $c$  such that the point  $(cs_1, cs_2)$  is a minimum distance from the point  $(v_1, v_2)$  by using calculus (i.e., consider the distance function, set the first derivative equal to zero, and solve). Generalize to  $\mathbb{R}^n$ .
- ✓ 1.18 Prove that the orthogonal projection of a vector into a line is shorter than the vector.
- ✓ 1.19 Show that the definition of orthogonal projection into a line does not depend on the spanning vector: if  $\vec{s}$  is a nonzero multiple of  $\vec{q}$  then  $(\vec{v} \cdot \vec{s} / \vec{s} \cdot \vec{s}) \cdot \vec{s}$  equals  $(\vec{v} \cdot \vec{q} / \vec{q} \cdot \vec{q}) \cdot \vec{q}$ .
- ✓ 1.20 Consider the function mapping the plane to itself that takes a vector to its projection into the line  $y = x$ . These two each show that the map is linear, the first one in a way that is coordinate-bound (that is, it fixes a basis and then computes) and the second in a way that is more conceptual.
- (a) Produce a matrix that describes the function's action.
- (b) Show that we can obtain this map by first rotating everything in the plane  $\pi/4$  radians clockwise, then projecting into the  $x$ -axis, and then rotating  $\pi/4$  radians counterclockwise.
- 1.21 For  $\vec{a}, \vec{b} \in \mathbb{R}^n$  let  $\vec{v}_1$  be the projection of  $\vec{a}$  into the line spanned by  $\vec{b}$ , let  $\vec{v}_2$  be the projection of  $\vec{v}_1$  into the line spanned by  $\vec{a}$ , let  $\vec{v}_3$  be the projection of  $\vec{v}_2$  into the line spanned by  $\vec{b}$ , etc., back and forth between the spans of  $\vec{a}$  and  $\vec{b}$ . That is,  $\vec{v}_{i+1}$  is the projection of  $\vec{v}_i$  into the span of  $\vec{a}$  if  $i + 1$  is even, and into the span of  $\vec{b}$  if  $i + 1$  is odd. Must that sequence of vectors eventually settle down—must there be a sufficiently large  $i$  such that  $\vec{v}_{i+2}$  equals  $\vec{v}_i$  and  $\vec{v}_{i+3}$  equals  $\vec{v}_{i+1}$ ? If so, what is the earliest such  $i$ ?

## VI.2 Gram-Schmidt Orthogonalization

*This subsection is optional. We only need the work done here in the final two sections of Chapter Five. Also, this subsection requires material from the previous subsection, which itself was optional.*

The prior subsection suggests that projecting into the line spanned by  $\vec{s}$  decomposes a vector  $\vec{v}$  into two parts

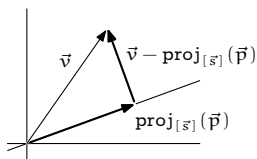

$$\vec{v} = \text{proj}_{[\vec{s}]}(\vec{v}) + (\vec{v} - \text{proj}_{[\vec{s}]}(\vec{v}))$$

that are orthogonal and so are not-interacting. We will now develop that suggestion.

**2.1 Definition** Vectors  $\vec{v}_1, \dots, \vec{v}_k \in \mathbb{R}^n$  are *mutually orthogonal* when any two are orthogonal: if  $i \neq j$  then the dot product  $\vec{v}_i \cdot \vec{v}_j$  is zero.

**2.2 Theorem** If the vectors in a set  $\{\vec{v}_1, \dots, \vec{v}_k\} \subset \mathbb{R}^n$  are mutually orthogonal and nonzero then that set is linearly independent.

**PROOF** Consider a linear relationship  $c_1\vec{v}_1 + c_2\vec{v}_2 + \dots + c_k\vec{v}_k = \vec{0}$ . If  $i \in \{1, \dots, k\}$  then taking the dot product of  $\vec{v}_i$  with both sides of the equation

$$\begin{aligned}\vec{v}_i \cdot (c_1\vec{v}_1 + c_2\vec{v}_2 + \dots + c_k\vec{v}_k) &= \vec{v}_i \cdot \vec{0} \\ c_i \cdot (\vec{v}_i \cdot \vec{v}_i) &= 0\end{aligned}$$

shows, since  $\vec{v}_i \neq \vec{0}$ , that  $c_i \neq 0$ .

QED

**2.3 Corollary** In a  $k$  dimensional vector space, if the vectors in a size  $k$  set are mutually orthogonal and nonzero then that set is a basis for the space.

**PROOF** Any linearly independent size  $k$  subset of a  $k$  dimensional space is a basis. QED

Of course, the converse of Corollary 2.3 does not hold — not every basis of every subspace of  $\mathbb{R}^n$  has mutually orthogonal vectors. However, we can get the partial converse that for every subspace of  $\mathbb{R}^n$  there is at least one basis consisting of mutually orthogonal vectors.

**2.4 Example** The members  $\vec{\beta}_1$  and  $\vec{\beta}_2$  of this basis for  $\mathbb{R}^2$  are not orthogonal.

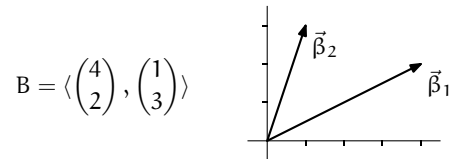

However, we can derive from  $B$  a new basis for the same space that does have mutually orthogonal members. For the first member of the new basis we simply use  $\vec{\beta}_1$ .

$$\vec{\kappa}_1 = \begin{pmatrix} 4 \\ 2 \end{pmatrix}$$

For the second member of the new basis, we subtract from  $\vec{\beta}_2$  the part in the direction of  $\vec{\kappa}_1$ . This leaves the part of  $\vec{\beta}_2$  that is orthogonal to  $\vec{\kappa}_1$ .

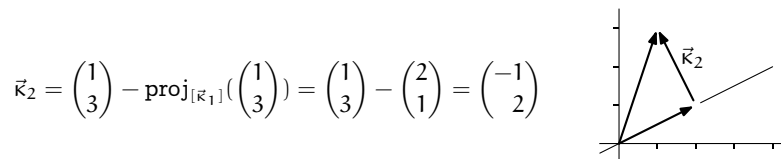

By the corollary  $\langle \vec{\kappa}_1, \vec{\kappa}_2 \rangle$  is a basis for  $\mathbb{R}^2$ .

**2.5 Definition** An *orthogonal basis* for a vector space is a basis of mutually orthogonal vectors.

**2.6 Example** To turn this basis for  $\mathbb{R}^3$

$$B = \left\langle \begin{pmatrix} 1 \\ 1 \\ 1 \end{pmatrix}, \begin{pmatrix} 0 \\ 2 \\ 0 \end{pmatrix}, \begin{pmatrix} 1 \\ 0 \\ 3 \end{pmatrix} \right\rangle$$

into an orthogonal basis we take the first vector as it is.

$$\vec{\kappa}_1 = \begin{pmatrix} 1 \\ 1 \\ 1 \end{pmatrix}$$

We get  $\vec{\kappa}_2$  by starting with  $\vec{\beta}_2$  and subtracting the part in the direction of  $\vec{\kappa}_1$ .

$$\vec{\kappa}_2 = \begin{pmatrix} 0 \\ 2 \\ 0 \end{pmatrix} - \text{proj}_{[\vec{\kappa}_1]} \left( \begin{pmatrix} 0 \\ 2 \\ 0 \end{pmatrix} \right) = \begin{pmatrix} 0 \\ 2 \\ 0 \end{pmatrix} - \begin{pmatrix} 2/3 \\ 2/3 \\ 2/3 \end{pmatrix} = \begin{pmatrix} -2/3 \\ 4/3 \\ -2/3 \end{pmatrix}$$

We get  $\vec{\kappa}_3$  by taking  $\vec{\beta}_3$  and subtracting the part in the direction of  $\vec{\kappa}_1$  and also the part in the direction of  $\vec{\kappa}_2$ .

$$\vec{\kappa}_3 = \begin{pmatrix} 1 \\ 0 \\ 3 \end{pmatrix} - \text{proj}_{[\vec{\kappa}_1]} \left( \begin{pmatrix} 1 \\ 0 \\ 3 \end{pmatrix} \right) - \text{proj}_{[\vec{\kappa}_2]} \left( \begin{pmatrix} 1 \\ 0 \\ 3 \end{pmatrix} \right) = \begin{pmatrix} -1 \\ 0 \\ 1 \end{pmatrix}$$

Again, the corollary gives the result is a basis for  $\mathbb{R}^3$ .

$$\left\langle \begin{pmatrix} 1 \\ 1 \\ 1 \end{pmatrix}, \begin{pmatrix} -2/3 \\ 4/3 \\ -2/3 \end{pmatrix}, \begin{pmatrix} -1 \\ 0 \\ 1 \end{pmatrix} \right\rangle$$

**2.7 Theorem (Gram-Schmidt orthogonalization)** If  $\langle \vec{\beta}_1, \dots, \vec{\beta}_k \rangle$  is a basis for a subspace of  $\mathbb{R}^n$  then the vectors

$$\begin{aligned} \vec{\kappa}_1 &= \vec{\beta}_1 \\ \vec{\kappa}_2 &= \vec{\beta}_2 - \text{proj}_{[\vec{\kappa}_1]}(\vec{\beta}_2) \\ \vec{\kappa}_3 &= \vec{\beta}_3 - \text{proj}_{[\vec{\kappa}_1]}(\vec{\beta}_3) - \text{proj}_{[\vec{\kappa}_2]}(\vec{\beta}_3) \\ &\vdots \\ \vec{\kappa}_k &= \vec{\beta}_k - \text{proj}_{[\vec{\kappa}_1]}(\vec{\beta}_k) - \dots - \text{proj}_{[\vec{\kappa}_{k-1}]}(\vec{\beta}_k) \end{aligned}$$

form an orthogonal basis for the same subspace.

**2.8 Remark** This is restricted to  $\mathbb{R}^n$  only because we have not given a definition of orthogonality for any other spaces.

**PROOF** We will use induction to check that each  $\vec{\kappa}_i$  is nonzero, is in the span of  $\langle \vec{\beta}_1, \dots, \vec{\beta}_i \rangle$ , and is orthogonal to all preceding vectors  $\vec{\kappa}_1 \cdot \vec{\kappa}_i = \dots = \vec{\kappa}_{i-1} \cdot \vec{\kappa}_i = 0$ . Then with Corollary 2.3 we will have that  $\langle \vec{\kappa}_1, \dots, \vec{\kappa}_k \rangle$  is a basis for the same space as is  $\langle \vec{\beta}_1, \dots, \vec{\beta}_k \rangle$ .

We shall only cover the cases up to  $i = 3$ , to give the sense of the argument. The remaining details are Exercise 25.

The  $i = 1$  case is trivial; setting  $\vec{\kappa}_1$  equal to  $\vec{\beta}_1$  makes it a nonzero vector since  $\vec{\beta}_1$  is a member of a basis, it is obviously in the span of  $\vec{\beta}_1$ , and the ‘orthogonal to all preceding vectors’ condition is satisfied vacuously.

In the  $i = 2$  case the expansion

$$\vec{\kappa}_2 = \vec{\beta}_2 - \text{proj}_{[\vec{\kappa}_1]}(\vec{\beta}_2) = \vec{\beta}_2 - \frac{\vec{\beta}_2 \cdot \vec{\kappa}_1}{\vec{\kappa}_1 \cdot \vec{\kappa}_1} \cdot \vec{\kappa}_1 = \vec{\beta}_2 - \frac{\vec{\beta}_2 \cdot \vec{\kappa}_1}{\vec{\kappa}_1 \cdot \vec{\kappa}_1} \cdot \vec{\beta}_1$$

shows that  $\vec{\kappa}_2 \neq \vec{0}$  or else this would be a non-trivial linear dependence among the  $\vec{\beta}$ 's (it is nontrivial because the coefficient of  $\vec{\beta}_2$  is 1). It also shows that  $\vec{\kappa}_2$  is in the span of the first two  $\vec{\beta}$ 's. And,  $\vec{\kappa}_2$  is orthogonal to the only preceding vector

$$\vec{\kappa}_1 \cdot \vec{\kappa}_2 = \vec{\kappa}_1 \cdot (\vec{\beta}_2 - \text{proj}_{[\vec{\kappa}_1]}(\vec{\beta}_2)) = 0$$

because this projection is orthogonal.

The  $i = 3$  case is the same as the  $i = 2$  case except for one detail. As in the  $i = 2$  case, expand the definition.

$$\begin{aligned} \vec{\kappa}_3 &= \vec{\beta}_3 - \frac{\vec{\beta}_3 \cdot \vec{\kappa}_1}{\vec{\kappa}_1 \cdot \vec{\kappa}_1} \cdot \vec{\kappa}_1 - \frac{\vec{\beta}_3 \cdot \vec{\kappa}_2}{\vec{\kappa}_2 \cdot \vec{\kappa}_2} \cdot \vec{\kappa}_2 \\ &= \vec{\beta}_3 - \frac{\vec{\beta}_3 \cdot \vec{\kappa}_1}{\vec{\kappa}_1 \cdot \vec{\kappa}_1} \cdot \vec{\beta}_1 - \frac{\vec{\beta}_3 \cdot \vec{\kappa}_2}{\vec{\kappa}_2 \cdot \vec{\kappa}_2} \cdot (\vec{\beta}_2 - \frac{\vec{\beta}_2 \cdot \vec{\kappa}_1}{\vec{\kappa}_1 \cdot \vec{\kappa}_1} \cdot \vec{\beta}_1) \end{aligned}$$

By the first line  $\vec{\kappa}_3 \neq \vec{0}$ , since  $\vec{\beta}_3$  isn't in the span  $[\vec{\beta}_1, \vec{\beta}_2]$  and therefore by the inductive hypothesis it isn't in the span  $[\vec{\kappa}_1, \vec{\kappa}_2]$ . By the second line  $\vec{\kappa}_3$  is in the span of the first three  $\vec{\beta}$ 's. Finally, the calculation below shows that  $\vec{\kappa}_3$  is orthogonal to  $\vec{\kappa}_1$ . (There is a difference between this calculation and the one in the  $i = 2$  case. Here the second line has two kinds of terms. As happened for  $i = 2$ , the first term is 0 because this projection is orthogonal. But here the second term is 0 because  $\vec{\kappa}_1$  is orthogonal to  $\vec{\kappa}_2$  and so is orthogonal to any vector in the line spanned by  $\vec{\kappa}_2$ .)

$$\begin{aligned} \vec{\kappa}_1 \cdot \vec{\kappa}_3 &= \vec{\kappa}_1 \cdot (\vec{\beta}_3 - \text{proj}_{[\vec{\kappa}_1]}(\vec{\beta}_3) - \text{proj}_{[\vec{\kappa}_2]}(\vec{\beta}_3)) \\ &= \vec{\kappa}_1 \cdot (\vec{\beta}_3 - \text{proj}_{[\vec{\kappa}_1]}(\vec{\beta}_3)) - \vec{\kappa}_1 \cdot \text{proj}_{[\vec{\kappa}_2]}(\vec{\beta}_3) \\ &= 0 \end{aligned}$$

A similar check shows that  $\vec{\kappa}_3$  is also orthogonal to  $\vec{\kappa}_2$ .

QED

Beyond having the vectors in the basis be orthogonal, we can also *normalize* each vector by dividing by its length, to end with an *orthonormal basis*.

**2.9 Example** From the orthogonal basis of Example 2.6, normalizing produces this orthonormal basis.

$$\left\langle \begin{pmatrix} 1/\sqrt{3} \\ 1/\sqrt{3} \\ 1/\sqrt{3} \end{pmatrix}, \begin{pmatrix} -1/\sqrt{6} \\ 2/\sqrt{6} \\ -1/\sqrt{6} \end{pmatrix}, \begin{pmatrix} -1/\sqrt{2} \\ 0 \\ 1/\sqrt{2} \end{pmatrix} \right\rangle$$

Besides its intuitive appeal, and its analogy with the standard basis  $\mathcal{E}_n$  for  $\mathbb{R}^n$ , an orthonormal basis also simplifies some computations. An example is in Exercise 19.

### Exercises

**2.10** Perform the Gram-Schmidt process on each of these bases for  $\mathbb{R}^2$ .

$$(a) \left\langle \begin{pmatrix} 1 \\ 1 \end{pmatrix}, \begin{pmatrix} 2 \\ 1 \end{pmatrix} \right\rangle \quad (b) \left\langle \begin{pmatrix} 0 \\ 1 \end{pmatrix}, \begin{pmatrix} -1 \\ 3 \end{pmatrix} \right\rangle \quad (c) \left\langle \begin{pmatrix} 0 \\ 1 \end{pmatrix}, \begin{pmatrix} -1 \\ 0 \end{pmatrix} \right\rangle$$

Then turn those orthogonal bases into orthonormal bases.

✓ **2.11** Perform the Gram-Schmidt process on each of these bases for  $\mathbb{R}^3$ .

$$(a) \left\langle \begin{pmatrix} 2 \\ 2 \\ 2 \end{pmatrix}, \begin{pmatrix} 1 \\ 0 \\ -1 \end{pmatrix}, \begin{pmatrix} 0 \\ 3 \\ 1 \end{pmatrix} \right\rangle \quad (b) \left\langle \begin{pmatrix} 1 \\ -1 \\ 0 \end{pmatrix}, \begin{pmatrix} 0 \\ 1 \\ 0 \end{pmatrix}, \begin{pmatrix} 2 \\ 3 \\ 1 \end{pmatrix} \right\rangle$$

Then turn those orthogonal bases into orthonormal bases.

✓ **2.12** Find an orthonormal basis for this subspace of  $\mathbb{R}^3$ : the plane  $x - y + z = 0$ .

**2.13** Find an orthonormal basis for this subspace of  $\mathbb{R}^4$ .

$$\left\{ \begin{pmatrix} x \\ y \\ z \\ w \end{pmatrix} \mid x - y - z + w = 0 \text{ and } x + z = 0 \right\}$$

**2.14** Show that any linearly independent subset of  $\mathbb{R}^n$  can be orthogonalized without changing its span.

**2.15** What happens if we try to apply the Gram-Schmidt process to a finite set that is not a basis?

✓ **2.16** What happens if we apply the Gram-Schmidt process to a basis that is already orthogonal?

**2.17** Let  $\langle \vec{\kappa}_1, \dots, \vec{\kappa}_k \rangle$  be a set of mutually orthogonal vectors in  $\mathbb{R}^n$ .

(a) Prove that for any  $\vec{v}$  in the space, the vector  $\vec{v} - (\text{proj}_{[\vec{\kappa}_1]}(\vec{v}) + \dots + \text{proj}_{[\vec{\kappa}_k]}(\vec{v}))$  is orthogonal to each of  $\vec{\kappa}_1, \dots, \vec{\kappa}_k$ .

(b) Illustrate the prior item in  $\mathbb{R}^3$  by using  $\vec{e}_1$  as  $\vec{\kappa}_1$ , using  $\vec{e}_2$  as  $\vec{\kappa}_2$ , and taking  $\vec{v}$  to have components 1, 2, and 3.

(c) Show that  $\text{proj}_{[\vec{\kappa}_1]}(\vec{v}) + \dots + \text{proj}_{[\vec{\kappa}_k]}(\vec{v})$  is the vector in the span of the set of  $\vec{\kappa}$ 's that is closest to  $\vec{v}$ . *Hint.* To the illustration done for the prior part, add a vector  $d_1\vec{\kappa}_1 + d_2\vec{\kappa}_2$  and apply the Pythagorean Theorem to the resulting triangle.

**2.18** Find a vector in  $\mathbb{R}^3$  that is orthogonal to both of these.

$$\begin{pmatrix} 1 \\ 5 \\ -1 \end{pmatrix} \quad \begin{pmatrix} 2 \\ 2 \\ 0 \end{pmatrix}$$

✓ **2.19** One advantage of orthogonal bases is that they simplify finding the representation of a vector with respect to that basis.

(a) For this vector and this non-orthogonal basis for  $\mathbb{R}^2$

$$\vec{v} = \begin{pmatrix} 2 \\ 3 \end{pmatrix} \quad B = \left\langle \begin{pmatrix} 1 \\ 1 \end{pmatrix}, \begin{pmatrix} 1 \\ 0 \end{pmatrix} \right\rangle$$

first represent the vector with respect to the basis. Then project the vector into the span of each basis vector  $[\vec{\beta}_1]$  and  $[\vec{\beta}_2]$ .

(b) With this orthogonal basis for  $\mathbb{R}^2$

$$K = \left\langle \begin{pmatrix} 1 \\ 1 \end{pmatrix}, \begin{pmatrix} 1 \\ -1 \end{pmatrix} \right\rangle$$

represent the same vector  $\vec{v}$  with respect to the basis. Then project the vector into the span of each basis vector. Note that the coefficients in the representation and the projection are the same.

(c) Let  $K = \langle \vec{\kappa}_1, \dots, \vec{\kappa}_k \rangle$  be an orthogonal basis for some subspace of  $\mathbb{R}^n$ . Prove that for any  $\vec{v}$  in the subspace, the  $i$ -th component of the representation  $\text{Rep}_K(\vec{v})$  is the scalar coefficient  $(\vec{v} \cdot \vec{\kappa}_i) / (\vec{\kappa}_i \cdot \vec{\kappa}_i)$  from  $\text{proj}_{[\vec{\kappa}_i]}(\vec{v})$ .

(d) Prove that  $\vec{v} = \text{proj}_{[\vec{\kappa}_1]}(\vec{v}) + \dots + \text{proj}_{[\vec{\kappa}_k]}(\vec{v})$ .

**2.20 Bessel's Inequality.** Consider these orthonormal sets

$$B_1 = \{ \vec{e}_1 \} \quad B_2 = \{ \vec{e}_1, \vec{e}_2 \} \quad B_3 = \{ \vec{e}_1, \vec{e}_2, \vec{e}_3 \} \quad B_4 = \{ \vec{e}_1, \vec{e}_2, \vec{e}_3, \vec{e}_4 \}$$

along with the vector  $\vec{v} \in \mathbb{R}^4$  whose components are 4, 3, 2, and 1.

(a) Find the coefficient  $c_1$  for the projection of  $\vec{v}$  into the span of the vector in  $B_1$ . Check that  $\|\vec{v}\|^2 \geq |c_1|^2$ .

(b) Find the coefficients  $c_1$  and  $c_2$  for the projection of  $\vec{v}$  into the spans of the two vectors in  $B_2$ . Check that  $\|\vec{v}\|^2 \geq |c_1|^2 + |c_2|^2$ .

(c) Find  $c_1$ ,  $c_2$ , and  $c_3$  associated with the vectors in  $B_3$ , and  $c_1$ ,  $c_2$ ,  $c_3$ , and  $c_4$  for the vectors in  $B_4$ . Check that  $\|\vec{v}\|^2 \geq |c_1|^2 + \dots + |c_3|^2$  and that  $\|\vec{v}\|^2 \geq |c_1|^2 + \dots + |c_4|^2$ .

Show that this holds in general: where  $\{ \vec{\kappa}_1, \dots, \vec{\kappa}_k \}$  is an orthonormal set and  $c_i$  is coefficient of the projection of a vector  $\vec{v}$  from the space then  $\|\vec{v}\|^2 \geq |c_1|^2 + \dots + |c_k|^2$ .

*Hint.* One way is to look at the inequality  $0 \leq \|\vec{v} - (c_1 \vec{\kappa}_1 + \dots + c_k \vec{\kappa}_k)\|^2$  and expand the  $c$ 's.

**2.21** Prove or disprove: every vector in  $\mathbb{R}^n$  is in some orthogonal basis.

**2.22** Show that the columns of an  $n \times n$  matrix form an orthonormal set if and only if the inverse of the matrix is its transpose. Produce such a matrix.

**2.23** Does the proof of Theorem 2.2 fail to consider the possibility that the set of vectors is empty (i.e., that  $k = 0$ )?

**2.24** Theorem 2.7 describes a change of basis from any basis  $B = \langle \vec{\beta}_1, \dots, \vec{\beta}_k \rangle$  to one that is orthogonal  $K = \langle \vec{\kappa}_1, \dots, \vec{\kappa}_k \rangle$ . Consider the change of basis matrix  $\text{Rep}_{B,K}(\text{id})$ .

(a) Prove that the matrix  $\text{Rep}_{K,B}(\text{id})$  changing bases in the direction opposite to that of the theorem has an upper triangular shape—all of its entries below the main diagonal are zeros.

(b) Prove that the inverse of an upper triangular matrix is also upper triangular (if the matrix is invertible, that is). This shows that the matrix  $\text{Rep}_{B,K}(\text{id})$  changing bases in the direction described in the theorem is upper triangular.

**2.25** Complete the induction argument in the proof of Theorem 2.7.

## VI.3 Projection Into a Subspace

*This subsection is optional. It also uses material from the optional earlier subsection on Combining Subspaces.*

The prior subsections project a vector into a line by decomposing it into two parts: the part in the line  $\text{proj}_{[\mathcal{S}]}(\vec{v})$  and the rest  $\vec{v} - \text{proj}_{[\mathcal{S}]}(\vec{v})$ . To generalize projection to arbitrary subspaces we will follow this decomposition idea.

**3.1 Definition** For any direct sum  $V = M \oplus N$  and any  $\vec{v} \in V$ , the *projection of  $\vec{v}$  into  $M$  along  $N$*  is

$$\text{proj}_{M,N}(\vec{v}) = \vec{m}$$

where  $\vec{v} = \vec{m} + \vec{n}$  with  $\vec{m} \in M$ ,  $\vec{n} \in N$ .

We can apply this definition in spaces where we don't have a ready definition of orthogonal. (Definitions of orthogonality for spaces other than the  $\mathbb{R}^n$  are perfectly possible but we haven't seen any in this book.)

**3.2 Example** The space  $\mathcal{M}_{2 \times 2}$  of  $2 \times 2$  matrices is the direct sum of these two.

$$M = \left\{ \begin{pmatrix} a & b \\ 0 & 0 \end{pmatrix} \mid a, b \in \mathbb{R} \right\} \quad N = \left\{ \begin{pmatrix} 0 & 0 \\ c & d \end{pmatrix} \mid c, d \in \mathbb{R} \right\}$$

To project

$$A = \begin{pmatrix} 3 & 1 \\ 0 & 4 \end{pmatrix}$$

into  $M$  along  $N$ , we first fix bases for the two subspaces.

$$B_M = \left\langle \begin{pmatrix} 1 & 0 \\ 0 & 0 \end{pmatrix}, \begin{pmatrix} 0 & 1 \\ 0 & 0 \end{pmatrix} \right\rangle \quad B_N = \left\langle \begin{pmatrix} 0 & 0 \\ 1 & 0 \end{pmatrix}, \begin{pmatrix} 0 & 0 \\ 0 & 1 \end{pmatrix} \right\rangle$$

The concatenation of these

$$B = B_M \hat{\cup} B_N = \left\langle \begin{pmatrix} 1 & 0 \\ 0 & 0 \end{pmatrix}, \begin{pmatrix} 0 & 1 \\ 0 & 0 \end{pmatrix}, \begin{pmatrix} 0 & 0 \\ 1 & 0 \end{pmatrix}, \begin{pmatrix} 0 & 0 \\ 0 & 1 \end{pmatrix} \right\rangle$$

is a basis for the entire space because  $\mathcal{M}_{2 \times 2}$  is the direct sum. So we can use it to represent  $A$ .

$$\begin{pmatrix} 3 & 1 \\ 0 & 4 \end{pmatrix} = 3 \cdot \begin{pmatrix} 1 & 0 \\ 0 & 0 \end{pmatrix} + 1 \cdot \begin{pmatrix} 0 & 1 \\ 0 & 0 \end{pmatrix} + 0 \cdot \begin{pmatrix} 0 & 0 \\ 1 & 0 \end{pmatrix} + 4 \cdot \begin{pmatrix} 0 & 0 \\ 0 & 1 \end{pmatrix}$$

The projection of  $A$  into  $M$  along  $N$  keeps the  $M$  part and drops the  $N$  part.

$$\text{proj}_{M,N} \left( \begin{pmatrix} 3 & 1 \\ 0 & 4 \end{pmatrix} \right) = 3 \cdot \begin{pmatrix} 1 & 0 \\ 0 & 0 \end{pmatrix} + 1 \cdot \begin{pmatrix} 0 & 1 \\ 0 & 0 \end{pmatrix} = \begin{pmatrix} 3 & 1 \\ 0 & 0 \end{pmatrix}$$

**3.3 Example** Both subscripts on  $\text{proj}_{M,N}(\vec{v})$  are significant. The first subscript  $M$  matters because the result of the projection is a member of  $M$ . For an example showing that the second one matters, fix this plane subspace of  $\mathbb{R}^3$  and its basis.

$$M = \left\{ \begin{pmatrix} x \\ y \\ z \end{pmatrix} \mid y - 2z = 0 \right\} \quad B_M = \left\langle \begin{pmatrix} 1 \\ 0 \\ 0 \end{pmatrix}, \begin{pmatrix} 0 \\ 2 \\ 1 \end{pmatrix} \right\rangle$$

Compare the projections along these (verification that  $\mathbb{R}^3 = M \oplus N$  and  $\mathbb{R}^3 = M \oplus \hat{N}$  is routine).

$$N = \left\{ k \begin{pmatrix} 0 \\ 0 \\ 1 \end{pmatrix} \mid k \in \mathbb{R} \right\} \quad \hat{N} = \left\{ k \begin{pmatrix} 0 \\ 1 \\ -2 \end{pmatrix} \mid k \in \mathbb{R} \right\}$$

The projections are different because they have different effects on this vector.

$$\vec{v} = \begin{pmatrix} 2 \\ 2 \\ 5 \end{pmatrix}$$

For the first one we find a basis for  $N$

$$B_N = \left\langle \begin{pmatrix} 0 \\ 0 \\ 1 \end{pmatrix} \right\rangle$$

and represent  $\vec{v}$  with respect to the concatenation  $B_M \hat{\ } B_N$ .

$$\begin{pmatrix} 2 \\ 2 \\ 5 \end{pmatrix} = 2 \cdot \begin{pmatrix} 1 \\ 0 \\ 0 \end{pmatrix} + 1 \cdot \begin{pmatrix} 0 \\ 2 \\ 1 \end{pmatrix} + 4 \cdot \begin{pmatrix} 0 \\ 0 \\ 1 \end{pmatrix}$$

We find the projection of  $\vec{v}$  into  $M$  along  $N$  by dropping the  $N$  component.

$$\text{proj}_{M,N}(\vec{v}) = 2 \cdot \begin{pmatrix} 1 \\ 0 \\ 0 \end{pmatrix} + 1 \cdot \begin{pmatrix} 0 \\ 2 \\ 1 \end{pmatrix} = \begin{pmatrix} 2 \\ 2 \\ 1 \end{pmatrix}$$

For  $\hat{N}$ , this basis is natural.

$$B_{\hat{N}} = \left\langle \begin{pmatrix} 0 \\ 1 \\ -2 \end{pmatrix} \right\rangle$$

Representing  $\vec{v}$  with respect to the concatenation

$$\begin{pmatrix} 2 \\ 2 \\ 5 \end{pmatrix} = 2 \cdot \begin{pmatrix} 1 \\ 0 \\ 0 \end{pmatrix} + (9/5) \cdot \begin{pmatrix} 0 \\ 2 \\ 1 \end{pmatrix} - (8/5) \cdot \begin{pmatrix} 0 \\ 1 \\ -2 \end{pmatrix}$$

and then keeping only the  $M$  part gives this.

$$\text{proj}_{M,\hat{N}}(\vec{v}) = 2 \cdot \begin{pmatrix} 1 \\ 0 \\ 0 \end{pmatrix} + (9/5) \cdot \begin{pmatrix} 0 \\ 2 \\ 1 \end{pmatrix} = \begin{pmatrix} 2 \\ 18/5 \\ 9/5 \end{pmatrix}$$

Therefore projection along different subspaces may yield different results.

These pictures compare the two maps. Both show that the projection is indeed 'into' the plane and 'along' the line.



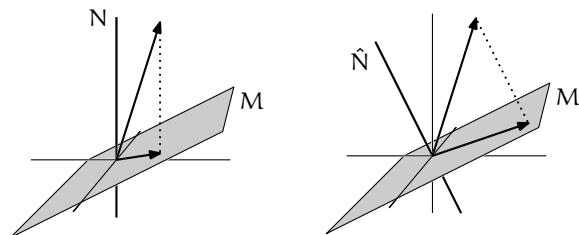

Notice that the projection along  $N$  is not orthogonal—there are members of the plane  $M$  that are not orthogonal to the dotted line. But the projection along  $\hat{N}$  is orthogonal.

A natural question is: what is the relationship between the projection operation defined above, and the operation of orthogonal projection into a line? The second picture above suggests the answer—orthogonal projection into a line is a special case of the projection defined above; it is just projection along a subspace perpendicular to the line.

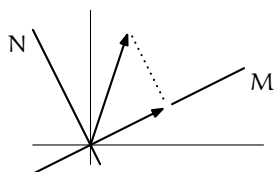

**3.4 Definition** The *orthogonal complement* of a subspace  $M$  of  $\mathbb{R}^n$  is

$$M^\perp = \{ \vec{v} \in \mathbb{R}^n \mid \vec{v} \text{ is perpendicular to all vectors in } M \}$$

(read “ $M$  perp”). The *orthogonal projection*  $\text{proj}_M(\vec{v})$  of a vector is its projection into  $M$  along  $M^\perp$ .

**3.5 Example** In  $\mathbb{R}^3$ , to find the orthogonal complement of the plane

$$P = \left\{ \begin{pmatrix} x \\ y \\ z \end{pmatrix} \mid 3x + 2y - z = 0 \right\}$$

we start with a basis for  $P$ .

$$B = \left\langle \begin{pmatrix} 1 \\ 0 \\ 3 \end{pmatrix}, \begin{pmatrix} 0 \\ 1 \\ 2 \end{pmatrix} \right\rangle$$

Any  $\vec{v}$  perpendicular to every vector in  $B$  is perpendicular to every vector in the span of  $B$  (the proof of this is Exercise 19). Therefore, the subspace  $P^\perp$  consists of the vectors that satisfy these two conditions.

$$\begin{pmatrix} 1 \\ 0 \\ 3 \end{pmatrix} \cdot \begin{pmatrix} v_1 \\ v_2 \\ v_3 \end{pmatrix} = 0 \quad \begin{pmatrix} 0 \\ 1 \\ 2 \end{pmatrix} \cdot \begin{pmatrix} v_1 \\ v_2 \\ v_3 \end{pmatrix} = 0$$

We can express those conditions more compactly as a linear system.

$$P^\perp = \left\{ \begin{pmatrix} v_1 \\ v_2 \\ v_3 \end{pmatrix} \mid \begin{pmatrix} 1 & 0 & 3 \\ 0 & 1 & 2 \end{pmatrix} \begin{pmatrix} v_1 \\ v_2 \\ v_3 \end{pmatrix} = \begin{pmatrix} 0 \\ 0 \end{pmatrix} \right\}$$

We are thus left with finding the nullspace of the map represented by the matrix, that is, with calculating the solution set of a homogeneous linear system.

$$\begin{aligned} v_1 + 3v_3 = 0 \\ v_2 + 2v_3 = 0 \end{aligned} \implies P^\perp = \left\{ k \begin{pmatrix} -3 \\ -2 \\ 1 \end{pmatrix} \mid k \in \mathbb{R} \right\}$$

Instead of the term orthogonal complement, this is sometimes called the line *normal* to the plane.

**3.6 Example** Where  $M$  is the  $xy$ -plane subspace of  $\mathbb{R}^3$ , what is  $M^\perp$ ? A common first reaction is that  $M^\perp$  is the  $yz$ -plane, but that's not right. Some vectors from the  $yz$ -plane are not perpendicular to every vector in the  $xy$ -plane.

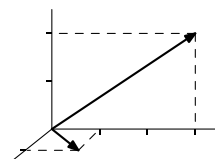

$$\begin{pmatrix} 1 \\ 1 \\ 0 \end{pmatrix} \not\perp \begin{pmatrix} 0 \\ 3 \\ 2 \end{pmatrix} \quad \theta = \arccos\left(\frac{1 \cdot 0 + 1 \cdot 3 + 0 \cdot 2}{\sqrt{2} \cdot \sqrt{13}}\right) \approx 0.94 \text{ rad}$$

Instead  $M^\perp$  is the  $z$ -axis, since proceeding as in the prior example and taking the natural basis for the  $xy$ -plane gives this.

$$M^\perp = \left\{ \begin{pmatrix} x \\ y \\ z \end{pmatrix} \mid \begin{pmatrix} 1 & 0 & 0 \\ 0 & 1 & 0 \end{pmatrix} \begin{pmatrix} x \\ y \\ z \end{pmatrix} = \begin{pmatrix} 0 \\ 0 \end{pmatrix} \right\} = \left\{ \begin{pmatrix} x \\ y \\ z \end{pmatrix} \mid x = 0 \text{ and } y = 0 \right\}$$

**3.7 Lemma** If  $M$  is a subspace of  $\mathbb{R}^n$  then orthogonal complement  $M^\perp$  is also a subspace. The space is the direct sum of the two  $\mathbb{R}^n = M \oplus M^\perp$ . And, for any  $\vec{v} \in \mathbb{R}^n$ , the vector  $\vec{v} - \text{proj}_M(\vec{v})$  is perpendicular to every vector in  $M$ .

**PROOF** First, the orthogonal complement  $M^\perp$  is a subspace of  $\mathbb{R}^n$  because, as noted in the prior two examples, it is a nullspace.

Next, start with any basis  $B_M = \langle \vec{\mu}_1, \dots, \vec{\mu}_k \rangle$  for  $M$  and expand it to a basis for the entire space. Apply the Gram-Schmidt process to get an orthogonal basis  $K = \langle \vec{\kappa}_1, \dots, \vec{\kappa}_n \rangle$  for  $\mathbb{R}^n$ . This  $K$  is the concatenation of two bases:  $\langle \vec{\kappa}_1, \dots, \vec{\kappa}_k \rangle$  with the same number of members  $k$  as  $B_M$ , and  $\langle \vec{\kappa}_{k+1}, \dots, \vec{\kappa}_n \rangle$ . The first is a basis for  $M$  so if we show that the second is a basis for  $M^\perp$  then we will have that the entire space is the direct sum of the two subspaces.

Exercise 19 from the prior subsection proves this about any orthogonal basis: each vector  $\vec{v}$  in the space is the sum of its orthogonal projections onto the lines spanned by the basis vectors.

$$\vec{v} = \text{proj}_{[\vec{\kappa}_1]}(\vec{v}) + \dots + \text{proj}_{[\vec{\kappa}_n]}(\vec{v}) \quad (*)$$

To check this, represent the vector as  $\vec{v} = r_1 \vec{\kappa}_1 + \cdots + r_n \vec{\kappa}_n$ , apply  $\vec{\kappa}_i$  to both sides  $\vec{v} \cdot \vec{\kappa}_i = (r_1 \vec{\kappa}_1 + \cdots + r_n \vec{\kappa}_n) \cdot \vec{\kappa}_i = r_1 \cdot 0 + \cdots + r_i \cdot (\vec{\kappa}_i \cdot \vec{\kappa}_i) + \cdots + r_n \cdot 0$ , and solve to get  $r_i = (\vec{v} \cdot \vec{\kappa}_i) / (\vec{\kappa}_i \cdot \vec{\kappa}_i)$ , as desired.

Since obviously any member of the span of  $\langle \vec{\kappa}_{k+1}, \dots, \vec{\kappa}_n \rangle$  is orthogonal to any vector in  $M$ , to show that this is a basis for  $M^\perp$  we need only show the other containment — that any  $\vec{w} \in M^\perp$  is in the span of this basis. The prior paragraph does this. Any  $\vec{w} \in M^\perp$  gives this on projections into basis vectors from  $M$ :  $\text{proj}_{[\vec{\kappa}_1]}(\vec{w}) = \vec{0}, \dots, \text{proj}_{[\vec{\kappa}_k]}(\vec{w}) = \vec{0}$ . Therefore equation (\*) gives that  $\vec{w}$  is a linear combination of  $\vec{\kappa}_{k+1}, \dots, \vec{\kappa}_n$ . Thus this is a basis for  $M^\perp$  and  $\mathbb{R}^n$  is the direct sum of the two.

The final sentence of the statement of this result is proved in much the same way. Write  $\vec{v} = \text{proj}_{[\vec{\kappa}_1]}(\vec{v}) + \cdots + \text{proj}_{[\vec{\kappa}_n]}(\vec{v})$ . Then  $\text{proj}_M(\vec{v})$  keeps only the  $M$  part and dropping the  $M^\perp$  part  $\text{proj}_M(\vec{v}) = \text{proj}_{[\vec{\kappa}_{k+1}]}(\vec{v}) + \cdots + \text{proj}_{[\vec{\kappa}_k]}(\vec{v})$ . Therefore  $\vec{v} - \text{proj}_M(\vec{v})$  consists of a linear combination of elements of  $M^\perp$  and so is perpendicular to every vector in  $M$ . QED

We can find the orthogonal projection into a subspace by following the steps of the proof but the next result gives a convenient formula.

**3.8 Theorem** Let  $\vec{v}$  be a vector in  $\mathbb{R}^n$  and let  $M$  be a subspace of  $\mathbb{R}^n$  with basis  $\langle \vec{\beta}_1, \dots, \vec{\beta}_k \rangle$ . If  $A$  is the matrix whose columns are the  $\vec{\beta}$ 's then  $\text{proj}_M(\vec{v}) = c_1 \vec{\beta}_1 + \cdots + c_k \vec{\beta}_k$  where the coefficients  $c_i$  are the entries of the vector  $(A^{\text{trans}} A)^{-1} A^{\text{trans}} \cdot \vec{v}$ . That is,  $\text{proj}_M(\vec{v}) = A(A^{\text{trans}} A)^{-1} A^{\text{trans}} \cdot \vec{v}$ .

**PROOF** The vector  $\text{proj}_M(\vec{v})$  is a member of  $M$  and so it is a linear combination of basis vectors  $c_1 \cdot \vec{\beta}_1 + \cdots + c_k \cdot \vec{\beta}_k$ . Since  $A$ 's columns are the  $\vec{\beta}$ 's, that can be expressed as: there is a  $\vec{c} \in \mathbb{R}^k$  such that  $\text{proj}_M(\vec{v}) = A\vec{c}$ . The vector  $\vec{v} - \text{proj}_M(\vec{v})$  is perpendicular to each member of the basis so we have this.

$$\vec{0} = A^{\text{trans}}(\vec{v} - A\vec{c}) = A^{\text{trans}}\vec{v} - A^{\text{trans}}A\vec{c}$$

Solving for  $\vec{c}$  (showing that  $A^{\text{trans}}A$  is invertible is an exercise)

$$\vec{c} = (A^{\text{trans}}A)^{-1} A^{\text{trans}} \cdot \vec{v}$$

gives the formula for the projection matrix as  $\text{proj}_M(\vec{v}) = A \cdot \vec{c}$ . QED

**3.9 Example** To orthogonally project this vector into this subspace

$$\vec{v} = \begin{pmatrix} 1 \\ -1 \\ 1 \end{pmatrix} \quad P = \left\{ \begin{pmatrix} x \\ y \\ z \end{pmatrix} \mid x + z = 0 \right\}$$

first make a matrix whose columns are a basis for the subspace

$$A = \begin{pmatrix} 0 & 1 \\ 1 & 0 \\ 0 & -1 \end{pmatrix}$$

and then compute.

$$\begin{aligned} A(A^{\text{trans}}A)^{-1}A^{\text{trans}} &= \begin{pmatrix} 0 & 1 \\ 1 & 0 \\ 0 & -1 \end{pmatrix} \begin{pmatrix} 1 & 0 \\ 0 & 1/2 \end{pmatrix} \begin{pmatrix} 0 & 1 & 0 \\ 1 & 0 & -1 \end{pmatrix} \\ &= \begin{pmatrix} 1/2 & 0 & -1/2 \\ 0 & 1 & 0 \\ -1/2 & 0 & 1/2 \end{pmatrix} \end{aligned}$$

With the matrix, calculating the orthogonal projection of any vector into  $P$  is easy.

$$\text{proj}_P(\vec{v}) = \begin{pmatrix} 1/2 & 0 & -1/2 \\ 0 & 1 & 0 \\ -1/2 & 0 & 1/2 \end{pmatrix} \begin{pmatrix} 1 \\ -1 \\ 1 \end{pmatrix} = \begin{pmatrix} 0 \\ -1 \\ 0 \end{pmatrix}$$

Note, as a check, that this result is indeed in  $P$ .

### Exercises

✓ 3.10 Project the vectors into  $M$  along  $N$ .

(a)  $\begin{pmatrix} 3 \\ -2 \end{pmatrix}$ ,  $M = \left\{ \begin{pmatrix} x \\ y \end{pmatrix} \mid x + y = 0 \right\}$ ,  $N = \left\{ \begin{pmatrix} x \\ y \end{pmatrix} \mid -x - 2y = 0 \right\}$

(b)  $\begin{pmatrix} 1 \\ 2 \end{pmatrix}$ ,  $M = \left\{ \begin{pmatrix} x \\ y \end{pmatrix} \mid x - y = 0 \right\}$ ,  $N = \left\{ \begin{pmatrix} x \\ y \end{pmatrix} \mid 2x + y = 0 \right\}$

(c)  $\begin{pmatrix} 3 \\ 0 \\ 1 \end{pmatrix}$ ,  $M = \left\{ \begin{pmatrix} x \\ y \\ z \end{pmatrix} \mid x + y = 0 \right\}$ ,  $N = \left\{ c \cdot \begin{pmatrix} 1 \\ 0 \\ 1 \end{pmatrix} \mid c \in \mathbb{R} \right\}$

✓ 3.11 Find  $M^\perp$ .

(a)  $M = \left\{ \begin{pmatrix} x \\ y \end{pmatrix} \mid x + y = 0 \right\}$     (b)  $M = \left\{ \begin{pmatrix} x \\ y \end{pmatrix} \mid -2x + 3y = 0 \right\}$

(c)  $M = \left\{ \begin{pmatrix} x \\ y \end{pmatrix} \mid x - y = 0 \right\}$     (d)  $M = \{ \vec{0} \}$     (e)  $M = \left\{ \begin{pmatrix} x \\ y \end{pmatrix} \mid x = 0 \right\}$

(f)  $M = \left\{ \begin{pmatrix} x \\ y \\ z \end{pmatrix} \mid -x + 3y + z = 0 \right\}$     (g)  $M = \left\{ \begin{pmatrix} x \\ y \\ z \end{pmatrix} \mid x = 0 \text{ and } y + z = 0 \right\}$

3.12 This subsection shows how to project orthogonally in two ways, the method of Example 3.2 and 3.3, and the method of Theorem 3.8. To compare them, consider the plane  $P$  specified by  $3x + 2y - z = 0$  in  $\mathbb{R}^3$ .

(a) Find a basis for  $P$ .

(b) Find  $P^\perp$  and a basis for  $P^\perp$ .

(c) Represent this vector with respect to the concatenation of the two bases from the prior item.

$$\vec{v} = \begin{pmatrix} 1 \\ 1 \\ 2 \end{pmatrix}$$

(d) Find the orthogonal projection of  $\vec{v}$  into  $P$  by keeping only the  $P$  part from the prior item.

(e) Check that against the result from applying Theorem 3.8.

- ✓ **3.13** We have three ways to find the orthogonal projection of a vector into a line, the Definition 1.1 way from the first subsection of this section, the Example 3.2 and 3.3 way of representing the vector with respect to a basis for the space and then keeping the  $M$  part, and the way of Theorem 3.8. For these cases, do all three ways.

$$(a) \vec{v} = \begin{pmatrix} 1 \\ -3 \end{pmatrix}, \quad M = \left\{ \begin{pmatrix} x \\ y \end{pmatrix} \mid x + y = 0 \right\}$$

$$(b) \vec{v} = \begin{pmatrix} 0 \\ 1 \\ 2 \end{pmatrix}, \quad M = \left\{ \begin{pmatrix} x \\ y \\ z \end{pmatrix} \mid x + z = 0 \text{ and } y = 0 \right\}$$

- 3.14** Check that the operation of Definition 3.1 is well-defined. That is, in Example 3.2 and 3.3, doesn't the answer depend on the choice of bases?

**3.15** What is the orthogonal projection into the trivial subspace?

**3.16** What is the projection of  $\vec{v}$  into  $M$  along  $N$  if  $\vec{v} \in M$ ?

**3.17** Show that if  $M \subseteq \mathbb{R}^n$  is a subspace with orthonormal basis  $\langle \vec{k}_1, \dots, \vec{k}_n \rangle$  then the orthogonal projection of  $\vec{v}$  into  $M$  is this.

$$(\vec{v} \cdot \vec{k}_1) \cdot \vec{k}_1 + \dots + (\vec{v} \cdot \vec{k}_n) \cdot \vec{k}_n$$

- ✓ **3.18** Prove that the map  $p: V \rightarrow V$  is the projection into  $M$  along  $N$  if and only if the map  $\text{id} - p$  is the projection into  $N$  along  $M$ . (Recall the definition of the difference of two maps:  $(\text{id} - p)(\vec{v}) = \text{id}(\vec{v}) - p(\vec{v}) = \vec{v} - p(\vec{v})$ .)

- ✓ **3.19** Show that if a vector is perpendicular to every vector in a set then it is perpendicular to every vector in the span of that set.

**3.20** True or false: the intersection of a subspace and its orthogonal complement is trivial.

**3.21** Show that the dimensions of orthogonal complements add to the dimension of the entire space.

- ✓ **3.22** Suppose that  $\vec{v}_1, \vec{v}_2 \in \mathbb{R}^n$  are such that for all complements  $M, N \subseteq \mathbb{R}^n$ , the projections of  $\vec{v}_1$  and  $\vec{v}_2$  into  $M$  along  $N$  are equal. Must  $\vec{v}_1$  equal  $\vec{v}_2$ ? (If so, what if we relax the condition to: all orthogonal projections of the two are equal?)

- ✓ **3.23** Let  $M, N$  be subspaces of  $\mathbb{R}^n$ . The perp operator acts on subspaces; we can ask how it interacts with other such operations.

(a) Show that two perps cancel:  $(M^\perp)^\perp = M$ .

(b) Prove that  $M \subseteq N$  implies that  $N^\perp \subseteq M^\perp$ .

(c) Show that  $(M + N)^\perp = M^\perp \cap N^\perp$ .

- ✓ **3.24** The material in this subsection allows us to express a geometric relationship that we have not yet seen between the rangespace and the nullspace of a linear map.

(a) Represent  $f: \mathbb{R}^3 \rightarrow \mathbb{R}$  given by

$$\begin{pmatrix} v_1 \\ v_2 \\ v_3 \end{pmatrix} \mapsto 1v_1 + 2v_2 + 3v_3$$

with respect to the standard bases and show that

$$\begin{pmatrix} 1 \\ 2 \\ 3 \end{pmatrix}$$

is a member of the perp of the nullspace. Prove that  $\mathcal{N}(f)^\perp$  is equal to the span of this vector.

(b) Generalize that to apply to any  $f: \mathbb{R}^n \rightarrow \mathbb{R}$ .

(c) Represent  $f: \mathbb{R}^3 \rightarrow \mathbb{R}^2$

$$\begin{pmatrix} v_1 \\ v_2 \\ v_3 \end{pmatrix} \mapsto \begin{pmatrix} 1v_1 + 2v_2 + 3v_3 \\ 4v_1 + 5v_2 + 6v_3 \end{pmatrix}$$

with respect to the standard bases and show that

$$\begin{pmatrix} 1 \\ 2 \\ 3 \end{pmatrix}, \begin{pmatrix} 4 \\ 5 \\ 6 \end{pmatrix}$$

are both members of the perp of the nullspace. Prove that  $\mathcal{N}(f)^\perp$  is the span of these two. (*Hint.* See the third item of Exercise 23.)

(d) Generalize that to apply to any  $f: \mathbb{R}^n \rightarrow \mathbb{R}^m$ .

In [Strang 93] this is called the *Fundamental Theorem of Linear Algebra*

**3.25** Define a *projection* to be a linear transformation  $t: V \rightarrow V$  with the property that repeating the projection does nothing more than does the projection alone:  $(t \circ t)(\vec{v}) = t(\vec{v})$  for all  $\vec{v} \in V$ .

(a) Show that orthogonal projection into a line has that property.

(b) Show that projection along a subspace has that property.

(c) Show that for any such  $t$  there is a basis  $B = \langle \vec{\beta}_1, \dots, \vec{\beta}_n \rangle$  for  $V$  such that

$$t(\vec{\beta}_i) = \begin{cases} \vec{\beta}_i & i = 1, 2, \dots, r \\ \vec{0} & i = r + 1, r + 2, \dots, n \end{cases}$$

where  $r$  is the rank of  $t$ .

(d) Conclude that every projection is a projection along a subspace.

(e) Also conclude that every projection has a representation

$$\text{Rep}_{B,B}(t) = \left( \begin{array}{c|c} I & Z \\ \hline Z & Z \end{array} \right)$$

in block partial-identity form.

**3.26** A square matrix is *symmetric* if each  $i, j$  entry equals the  $j, i$  entry (i.e., if the matrix equals its transpose). Show that the projection matrix  $A(A^{\text{trans}}A)^{-1}A^{\text{trans}}$  is symmetric. [Strang 80] *Hint.* Find properties of transposes by looking in the index under ‘transpose’.

## Topic

---

### Line of Best Fit

*This Topic requires the formulas from the subsections on Orthogonal Projection Into a Line and Projection Into a Subspace.*

Scientists are often presented with a system that has no solution and they must find an answer anyway. More precisely stated, they must find a best answer.

For instance, this is the result of flipping a penny, including some intermediate numbers.

<i>number of flips</i>	30	60	90
<i>number of heads</i>	16	34	51

In an experiment we can expect that samples will vary—here, sometimes the experimental ratio of heads to flips overestimates this penny’s long-term ratio and sometimes it underestimates. So we expect that the system derived from the experiment has no solution.

$$30m = 16$$

$$60m = 34$$

$$90m = 51$$

That is, the vector of data that we collected is not in the subspace where in theory we should find it.

$$\begin{pmatrix} 16 \\ 34 \\ 51 \end{pmatrix} \notin \left\{ m \begin{pmatrix} 30 \\ 60 \\ 90 \end{pmatrix} \mid m \in \mathbb{R} \right\}$$

We have to do something, so we look for the  $m$  that most nearly works. An orthogonal projection of the data vector into the line subspace gives this best guess.

$$\frac{\begin{pmatrix} 16 \\ 34 \\ 51 \end{pmatrix} \cdot \begin{pmatrix} 30 \\ 60 \\ 90 \end{pmatrix}}{\begin{pmatrix} 30 \\ 60 \\ 90 \end{pmatrix} \cdot \begin{pmatrix} 30 \\ 60 \\ 90 \end{pmatrix}} \cdot \begin{pmatrix} 30 \\ 60 \\ 90 \end{pmatrix} = \frac{7110}{12600} \cdot \begin{pmatrix} 30 \\ 60 \\ 90 \end{pmatrix}$$

The estimate ( $m = 7110/12600 \approx 0.56$ ) is a bit more than one half, but not much, so probably the penny is fair enough.

The line with the slope  $m \approx 0.56$  is the *line of best fit* for this data.

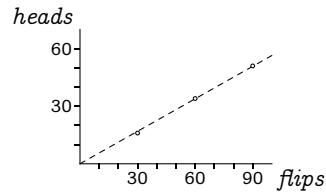

Minimizing the distance between the given vector and the vector used as the right-hand side minimizes the total of these vertical lengths, and consequently we say that the line comes from *fitting by least-squares*

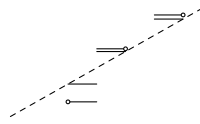

(we have exaggerated the vertical scale by ten to make the lengths visible).

In the above equation the line must pass through  $(0, 0)$ , because we take it to be the line whose slope is this coin's true proportion of heads to flips. We can also handle cases where the line need not pass through the origin.

For example, the different denominations of US money have different average times in circulation.[[Federal Reserve](#)] (The \$2 bill is a special case because Americans mistakenly believe that it is collectible and do not circulate these bills.) How long should a \$25 bill last?

denomination	1	5	10	20	50	100
average life (mos)	22.0	15.9	18.3	24.3	55.4	88.8

The data plot below looks roughly linear. It isn't a perfect line, i.e., the linear system with equations  $b + 1m = 1.5, \dots, b + 100m = 20$  has no solution, but we can again use orthogonal projection to find a best approximation. Consider the matrix of coefficients of that linear system and also its vector of constants, the experimentally-determined values.

$$A = \begin{pmatrix} 1 & 1 \\ 1 & 5 \\ 1 & 10 \\ 1 & 20 \\ 1 & 50 \\ 1 & 100 \end{pmatrix} \quad \vec{v} = \begin{pmatrix} 22.0 \\ 15.9 \\ 18.3 \\ 24.3 \\ 55.4 \\ 88.8 \end{pmatrix}$$

The ending result in the subsection on Projection into a Subspace says that coefficients  $b$  and  $m$  so that the linear combination of the columns of  $A$  is as close as possible to the vector  $\vec{v}$  are the entries of  $(A^{\text{trans}}A)^{-1}A^{\text{trans}} \cdot \vec{v}$ . Some calculation gives an intercept of  $b = 14.16$  and a slope of  $m = 0.75$ .



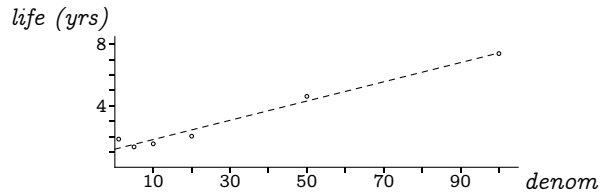

Plugging  $x = 25$  into the equation of the line shows that such a bill should last about two and three-quarters years.

We close by considering the progression of world record times for the men's mile race [Oakley & Baker]. In the early 1900's many people wondered when this record would fall below the four minute mark. Here are the times that were in force on January first of each decade through the first half of that century. (Restricting ourselves to the times at the start of each decade reduces the data entry burden and gives much the same result. There are different sequences of times from competing standards bodies but these are from [Wikipedia Mens Mile].)

year	1870	1880	1890	1900	1910	1920	1930	1940	1950
secs	268.8	264.5	258.4	255.6	255.6	252.6	250.4	246.4	241.4

We can use this to predict the date for 240 seconds, and we can then compare to the actual date.

*Sage* gives the slope and intercept.

```
sage: data=[[1870,268.8], [1880,264.5], [1890,258.4],
....: [1900,255.6], [1910,255.6], [1920,252.6],
....: [1930,250.4], [1940,246.4], [1950,241.4]]
sage: var('slope,intercept')
(slope, intercept)
sage: model(x) = slope*x+intercept
sage: find_fit(data,model)
[intercept == 837.0872267857003,
 slope == -0.30483333572258886]
```

(People in the year 0 didn't run very fast!) Plotting the data and the line

```
sage: points(data)
....: +plot(model(intercept=find_fit(data,model)[0].rhs(),
....: slope=find_fit(data,model)[1].rhs()),
....: (x,1860,1960),color='red',figsize=3,fontsize=7)
```

gives this graph.

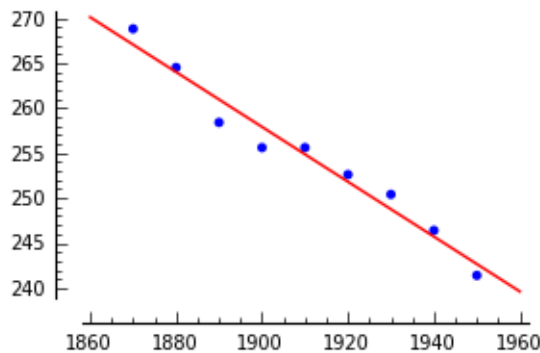



The temperature that day was forecast to be  $31^{\circ}\text{F}$ .

- (a) NASA based the decision to launch partially on a chart showing only the flights that had at least one O-ring failure. Find the line that best fits these seven flights. On the basis of this data, predict the number of O-ring failures when the temperature is 31, and when the number of failures will exceed four.
- (b) Find the line that best fits all 24 flights. On the basis of this extra data, predict the number of O-ring failures when the temperature is 31, and when the number of failures will exceed four.

Which do you think is the more accurate method of predicting? (An excellent discussion is in [Dalal, et. al].)

- 8 This table lists the average distance from the sun to each of the first seven planets, using Earth's average as a unit.

Mercury	Venus	Earth	Mars	Jupiter	Saturn	Uranus
0.39	0.72	1.00	1.52	5.20	9.54	19.2

- (a) Plot the number of the planet (Mercury is 1, etc.) versus the distance. Note that it does not look like a line, and so finding the line of best fit is not fruitful.
- (b) It does, however look like an exponential curve. Therefore, plot the number of the planet versus the logarithm of the distance. Does this look like a line?
- (c) The asteroid belt between Mars and Jupiter is what is left of a planet that broke apart. Renumber so that Jupiter is 6, Saturn is 7, and Uranus is 8, and plot against the log again. Does this look better?
- (d) Use least squares on that data to predict the location of Neptune.
- (e) Repeat to predict where Pluto is.
- (f) Is the formula accurate for Neptune and Pluto?

This method was used to help discover Neptune (although the second item is misleading about the history; actually, the discovery of Neptune in position 9 prompted people to look for the "missing planet" in position 5). See [Gardner, 1970]

## Geometry of Linear Maps

The pictures below contrast the nonlinear maps  $f_1(x) = e^x$  and  $f_2(x) = x^2$  with the linear maps  $h_1(x) = 2x$  and  $h_2(x) = -x$ . Each shows the domain  $\mathbb{R}^1$  on the left mapped to the codomain  $\mathbb{R}^1$  on the right. Arrows trace where each map sends  $x = 0$ ,  $x = 1$ ,  $x = 2$ ,  $x = -1$ , and  $x = -2$ .

Note how the nonlinear maps distort the domain in transforming it into the range. For instance,  $f_1(1)$  is further from  $f_1(2)$  than it is from  $f_1(0)$ —the map spreads the domain out unevenly so that in moving from domain to range an interval near  $x = 2$  spreads apart more than is an interval near  $x = 0$ .

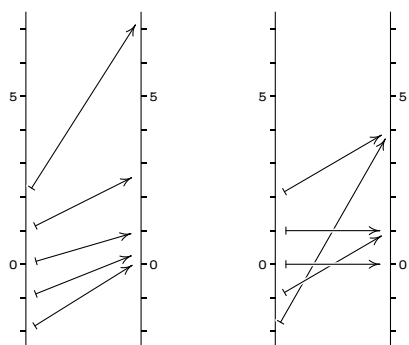

The linear maps are nicer, more regular, in that for each map all of the domain spreads by the same factor.

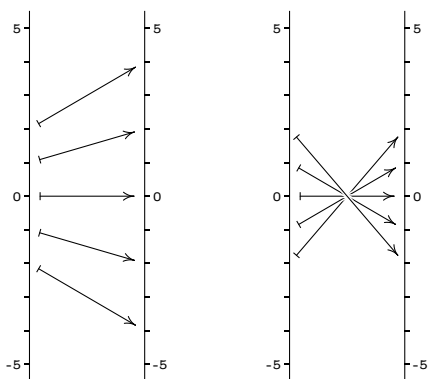

The only linear maps from  $\mathbb{R}^1$  to  $\mathbb{R}^1$  are multiplications by a scalar but in higher dimensions more can happen. For instance, this linear transformation of  $\mathbb{R}^2$  rotates vectors counterclockwise.

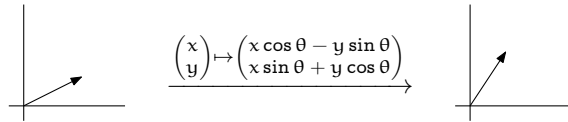

The transformation of  $\mathbb{R}^3$  that projects vectors into the  $xz$ -plane is also not simply a rescaling.

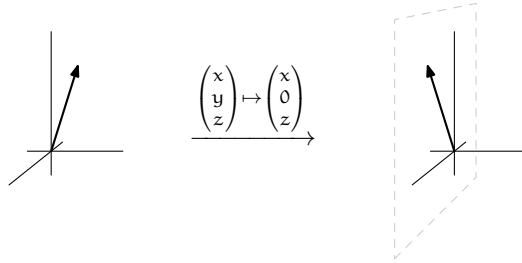

Nonetheless, even in higher dimensions the linear maps behave nicely. Consider a linear map  $h: \mathbb{R}^n \rightarrow \mathbb{R}^m$ . We will use the standard bases to represent it by a matrix  $H$ . Recall that any such  $H$  factors as  $H = PBQ$ , where  $P$  and  $Q$  are nonsingular and  $B$  is a partial-identity matrix. Recall also that nonsingular matrices factor into elementary matrices  $PBQ = T_n T_{n-1} \cdots T_j B T_{j-1} \cdots T_1$ , which are matrices that come from the identity  $I$  after one Gaussian step

$$I \xrightarrow{k\rho_i} M_i(k) \quad I \xrightarrow{\rho_i \leftrightarrow \rho_j} P_{i,j} \quad I \xrightarrow{k\rho_i + \rho_j} C_{i,j}(k)$$

for  $i \neq j, k \neq 0$ . So if we understand the effect of a linear map described by a partial-identity matrix and the effect of the linear maps described by the elementary matrices then we will in some sense understand the effect of any linear map. (To understand them we mean to give a description of their geometric effect; the pictures below stick to transformations of  $\mathbb{R}^2$  for ease of drawing but the principles extend for maps from any  $\mathbb{R}^n$  to any  $\mathbb{R}^m$ .)

The geometric effect of the linear transformation represented by a partial-identity matrix is projection.

$$\begin{pmatrix} x \\ y \\ z \end{pmatrix} \xrightarrow{\begin{pmatrix} 1 & 0 & 0 \\ 0 & 1 & 0 \\ 0 & 0 & 0 \end{pmatrix}_{\varepsilon_3, \varepsilon_3}} \begin{pmatrix} x \\ y \\ 0 \end{pmatrix}$$

The geometric effect of the  $M_i(k)$  matrices is to stretch vectors by a factor of  $k$  along the  $i$ -th axis. This map stretches by a factor of 3 along the  $x$ -axis.

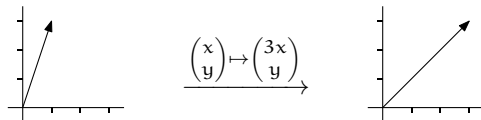

If  $0 \leq k < 1$  or if  $k < 0$  then the  $i$ -th component goes the other way, here to the left.

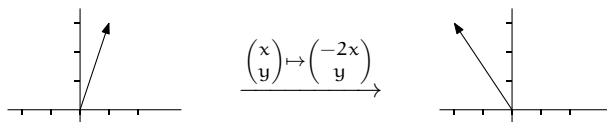

Either of these is a *dilation*.

A transformation represented by a  $P_{i,j}$  matrix interchanges the  $i$ -th and  $j$ -th axes. This is *reflection* about the line  $x_i = x_j$ .

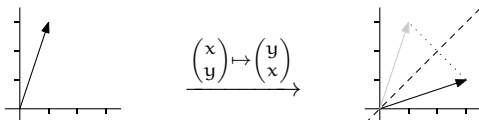

Permutations involving more than two axes decompose into a combination of swaps of pairs of axes; see Exercise 5.

The remaining matrices have the form  $C_{i,j}(k)$ . For instance  $C_{1,2}(2)$  performs  $2\rho_1 + \rho_2$ .

$$\begin{pmatrix} x \\ y \end{pmatrix} \xrightarrow{\begin{pmatrix} 1 & 0 \\ 2 & 1 \end{pmatrix}_{\varepsilon_2, \varepsilon_2}} \begin{pmatrix} x \\ 2x + y \end{pmatrix}$$

In the picture below, the vector  $\vec{u}$  with the first component of 1 is affected less than the vector  $\vec{v}$  with the first component of 2 —  $h(\vec{u})$  is only 2 higher than  $\vec{u}$  while  $h(\vec{v})$  is 4 higher than  $\vec{v}$ .

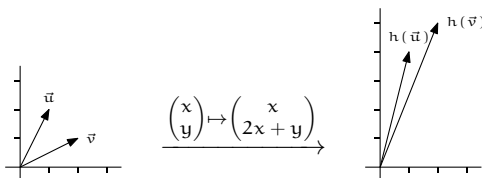

Any vector with a first component of 1 would be affected in the same way as  $\vec{u}$ ; it would slide up by 2. And any vector with a first component of 2 would slide up 4, as was  $\vec{v}$ . That is, the transformation represented by  $C_{i,j}(k)$  affects vectors depending on their  $i$ -th component.

Another way to see this point is to consider the action of this map on the unit square. In the next picture, vectors with a first component of 0, like the origin, are not pushed vertically at all but vectors with a positive first component slide up. Here, all vectors with a first component of 1, the entire right side of the square, slide to the same extent. In general, vectors on the same vertical line slide by the same amount, by twice their first component. The shape of the result, a rhombus, has the same base and height as the square (and thus the same area) but the right angle corners are gone.

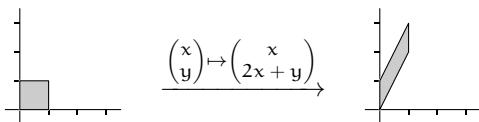

For contrast the next picture shows the effect of the map represented by  $C_{2,1}(1)$ . Here vectors are affected according to their second component:  $\begin{pmatrix} x \\ y \end{pmatrix}$  slides horizontally by twice  $y$ .

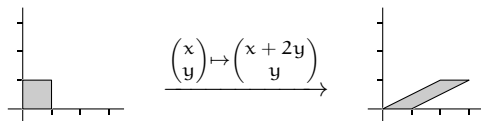

This kind of map is a *skew*.

With that, we understand the geometric effect of the four types of components in the expansion  $H = T_n T_{n-1} \cdots T_j B T_{j-1} \cdots T_1$ , and so, in some sense, we have an understanding of the action of any matrix  $H$ .

We will illustrate the usefulness of our understanding in two ways. The first is that we will use it to prove something about linear maps. Recall that under a linear map, the image of a subspace is a subspace and thus the linear transformation  $h$  represented by  $H$  maps lines through the origin to lines through the origin. (The dimension of the image space cannot be greater than the dimension of the domain space, so a line can't map onto, say, a plane.) We will show that  $h$  maps any line, not just one through the origin, to a line. The proof is simple: the partial-identity projection  $B$  and the elementary  $T_i$ 's each turn a line input into a line output (verifying the four cases is Exercise 6). Therefore their composition also preserves lines.

The second way that we will illustrate the usefulness of our understanding is to apply it to Calculus. Below is a picture of the action of the one-variable real function  $y(x) = x^2 + x$ . As we noted at that start of this Topic, overall the geometric effect of this map is irregular in that at different domain points it has different effects; for example as the domain point  $x$  goes from 2 to  $-2$ , the associated range point  $f(x)$  at first decreases, then pauses instantaneously, and then increases.

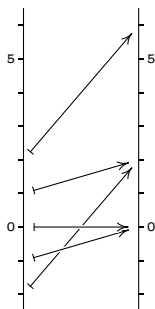

But in Calculus we focus less on the map overall, and more on the local effect of the map. The picture below looks closely at what this map does near  $x = 1$ . The derivative is  $dy/dx = 2x + 1$  so that near  $x = 1$  we have  $\Delta y \approx 3 \cdot \Delta x$ . That is, in a neighborhood of  $x = 1$ , in carrying the domain to the codomain this map causes it to grow by a factor of 3—it is, locally, approximately, a dilation. The picture below shows a small interval in the domain  $(1 - \Delta x .. 1 + \Delta x)$  carried

over to an interval in the codomain  $(2 - \Delta y .. 2 + \Delta y)$  that is three times as wide  $\Delta y \approx 3 \cdot \Delta x$ .

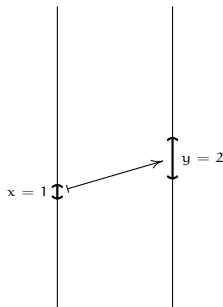

In higher dimensions the idea is the same but more can happen than in the  $\mathbb{R}^1$ -to- $\mathbb{R}^1$  scalar multiplication case. For a function  $y: \mathbb{R}^n \rightarrow \mathbb{R}^m$  and a point  $\vec{x} \in \mathbb{R}^n$ , the derivative is defined to be the linear map  $h: \mathbb{R}^n \rightarrow \mathbb{R}^m$  that best approximates how  $y$  changes near  $y(\vec{x})$ . So the geometry studied above directly applies to the derivatives.

We will close this Topic by remarking how this point of view makes clear an often misunderstood but very important result about derivatives, the Chain Rule. Recall that, with suitable conditions on the two functions, the derivative of the composition is this.

$$\frac{d(g \circ f)}{dx}(x) = \frac{dg}{dx}(f(x)) \cdot \frac{df}{dx}(x)$$

For instance the derivative of  $\sin(x^2 + 3x)$  is  $\cos(x^2 + 3x) \cdot (2x + 3)$ .

Where does this come from? Consider the  $f, g: \mathbb{R}^1 \rightarrow \mathbb{R}^1$  picture.

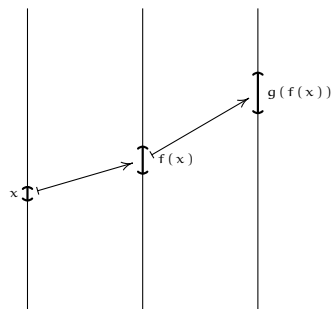

The first map  $f$  dilates the neighborhood of  $x$  by a factor of

$$\frac{df}{dx}(x)$$

and the second map  $g$  follows that by dilating a neighborhood of  $f(x)$  by a factor of

$$\frac{dg}{dx}(f(x))$$

and when combined, the composition dilates by the product of the two. In higher dimensions the map expressing how a function changes near a point is



a linear map, and is represented by a matrix. The Chain Rule multiplies the matrices.

Thus, the geometry of linear maps  $h: \mathbb{R}^n \rightarrow \mathbb{R}^m$  is appealing both for its simplicity and for its usefulness.

### Exercises

1 Let  $h: \mathbb{R}^2 \rightarrow \mathbb{R}^2$  be the transformation that rotates vectors clockwise by  $\pi/4$  radians.

(a) Find the matrix  $H$  representing  $h$  with respect to the standard bases. Use Gauss' method to reduce  $H$  to the identity.

(b) Translate the row reduction to a matrix equation  $T_j T_{j-1} \cdots T_1 H = I$  (the prior item shows both that  $H$  is similar to  $I$ , and that we need no column operations to derive  $I$  from  $H$ ).

(c) Solve this matrix equation for  $H$ .

(d) Sketch how  $H$  is a combination of dilations, flips, skews, and projections (the identity is a trivial projection).

2 What combination of dilations, flips, skews, and projections produces a rotation counterclockwise by  $2\pi/3$  radians?

3 What combination of dilations, flips, skews, and projections produces the map  $h: \mathbb{R}^3 \rightarrow \mathbb{R}^3$  represented with respect to the standard bases by this matrix?

$$\begin{pmatrix} 1 & 2 & 1 \\ 3 & 6 & 0 \\ 1 & 2 & 2 \end{pmatrix}$$

4 Show that any linear transformation of  $\mathbb{R}^1$  is the map that multiplies by a scalar  $x \mapsto kx$ .

5 Show that for any permutation (that is, reordering)  $p$  of the numbers  $1, \dots, n$ , the map

$$\begin{pmatrix} x_1 \\ x_2 \\ \vdots \\ x_n \end{pmatrix} \mapsto \begin{pmatrix} x_{p(1)} \\ x_{p(2)} \\ \vdots \\ x_{p(n)} \end{pmatrix}$$

can be done with a composition of maps, each of which only swaps a single pair of coordinates. *Hint:* you can use induction on  $n$ . (*Remark:* in the fourth chapter we will show this and we will also show that the parity of the number of swaps used is determined by  $p$ . That is, although a particular permutation could be expressed in two different ways with two different numbers of swaps, either both ways use an even number of swaps, or both use an odd number.)

6 Show that linear maps preserve the linear structures of a space.

(a) Show that for any linear map from  $\mathbb{R}^n$  to  $\mathbb{R}^m$ , the image of any line is a line. The image may be a degenerate line, that is, a single point.

(b) Show that the image of any linear surface is a linear surface. This generalizes the result that under a linear map the image of a subspace is a subspace.

(c) Linear maps preserve other linear ideas. Show that linear maps preserve "betweenness": if the point  $B$  is between  $A$  and  $C$  then the image of  $B$  is between the image of  $A$  and the image of  $C$ .

7 Use a picture like the one that appears in the discussion of the Chain Rule to answer: if a function  $f: \mathbb{R} \rightarrow \mathbb{R}$  has an inverse, what's the relationship between how the function — locally, approximately — dilates space, and how its inverse dilates space (assuming, of course, that it has an inverse)?

## Topic

---

# Magic Squares

A Chinese legend tells the story of a flood by the Lo river. The people offered sacrifices to appease the river. But each time a turtle emerged, walked around the sacrifice, and returned to the water. Fuh-Hi, the founder of Chinese civilization, interpreted this to mean that the river was still annoyed. Fortunately, a child noticed that on its shell the turtle had the pattern on the left below, which is today called Lo Shu (“river scroll”).

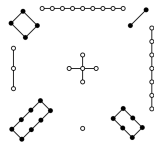

4	9	2
3	5	7
8	1	6

The dots make the matrix on the right where the rows, columns, and diagonals add to 15. Now that the people knew how much to sacrifice, the river’s anger cooled.

A square matrix is *magic* if each row, column, and diagonal add to the same value, the matrix’s *magic number*.

Another example of a magic square appears in the engraving *Melencolia I* by Albrecht Dürer.



One interpretation is that it depicts melancholy, a depressed state. The figure, genius, has a wealth of fascinating things to explore including the compass, the geometrical solid, the scale, and the hourglass. But the figure is unmoved; all of these things lie unused. One of the potential delights, in the upper right, is a  $4 \times 4$  matrix whose rows, columns, and diagonals add to 34.

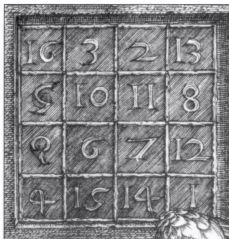

16	3	2	13
5	10	11	8
9	6	7	12
4	15	14	1

The middle entries on the bottom row give 1514, the date of the engraving.

The above two squares are arrangements of  $1 \dots n^2$ . They are *normal*. The  $1 \times 1$  square whose sole entry is 1 is normal, there is no normal  $2 \times 2$  magic square by Exercise 2, and there are normal magic squares of every other size; see [Wikipedia Magic Square]. Finding the number of normal magic squares of each size is an unsolved problem; see [Online Encyclopedia of Integer Sequences].

If we don't require that the squares be normal then we can say much more. Every  $1 \times 1$  square is magic, trivially. If the rows, columns, and diagonals of a  $2 \times 2$  matrix

$$\begin{pmatrix} a & b \\ c & d \end{pmatrix}$$

add to  $s$  then  $a + b = s$ ,  $c + d = s$ ,  $a + c = s$ ,  $b + d = s$ ,  $a + d = s$ , and  $b + c = s$ . Exercise 2 shows that this system has the unique solution  $a = b = c = d = s/2$ . So the set of  $2 \times 2$  magic squares is a one-dimensional subspace of  $\mathcal{M}_{2 \times 2}$ .

In general, a sum of two same-sized magic squares is magic and a scalar multiple of a magic square is magic so the set of  $n \times n$  magic squares  $\mathcal{M}_n$  is a vector space, a subspace of  $\mathcal{M}_{n \times n}$ . This Topic shows that for  $n \geq 3$  the dimension of  $\mathcal{M}_n$  is  $n^2 - n$ . The set  $\mathcal{M}_{n,0}$  of  $n \times n$  magic squares with magic number 0 is another subspace, and we will find the formula for its dimension also:  $n^2 - 2n - 1$  when  $n \geq 3$ .

We will first prove that  $\dim \mathcal{M}_n = \dim \mathcal{M}_{n,0} + 1$ . Define the *trace* of a matrix to be the sum down its upper-left to lower-right diagonal  $\text{Tr}(M) = m_{1,1} + \dots + m_{n,n}$ . Consider the restriction of the trace to the magic squares  $\text{Tr}: \mathcal{M}_n \rightarrow \mathbb{R}$ . The nullspace  $\mathcal{N}(\text{Tr})$  is the set of magic squares with magic number zero  $\mathcal{M}_{n,0}$ . Observe that the trace is onto because for any  $r$  in the codomain  $\mathbb{R}$  the  $n \times n$  matrix whose entries are all  $r/n$  is a magic square with magic number  $r$ . Theorem Two.II.2.14 says that for any linear map the dimension of the domain equals the dimension of the rangespace plus the dimension of the nullspace, the map's rank plus its nullity. Here the domain is  $\mathcal{M}_n$ , the rangespace is  $\mathbb{R}$  and the nullspace is  $\mathcal{M}_{n,0}$ , so we have that  $\dim \mathcal{M}_n = 1 + \dim \mathcal{M}_{n,0}$ .

We will finish by showing that  $\dim \mathcal{M}_{n,0} = n^2 - 2n - 1$  for  $n \geq 3$ . (For  $n = 1$  the dimension is clearly 0. Exercise 3 shows it is also 0 for  $n = 2$ .) If the

rows, columns, and diagonals of a matrix

$$\begin{pmatrix} a & b & c \\ d & e & f \\ g & h & i \end{pmatrix}$$

add to zero then we have an  $(2n + 2) \times n^2$  linear system.

$$\begin{array}{rcccc} a + b + c & & & = 0 \\ & d + e + f & & = 0 \\ & & g + h + i & = 0 \\ a & + d & + g & = 0 \\ & b & + e & + h = 0 \\ & & c & + f + i = 0 \\ a & & + e & + i = 0 \\ & c & + e & + g = 0 \end{array}$$

The matrix of coefficients for the particular cases of  $n = 3$  and  $n = 4$  are below, with the rows and columns numbered to help in reading the proof. With respect to the standard basis, each represents a linear map  $h: \mathbb{R}^{n^2} \rightarrow \mathbb{R}^{2n+2}$ . The domain has dimension  $n^2$  so if we show that the rank of the matrix is  $2n + 1$  then we will have what we want, that the dimension of the nullspace  $\mathcal{M}_{n,0}$  is  $n^2 - (2n + 1)$ .

	1	2	3	4	5	6	7	8	9
$\vec{\rho}_1$	1	1	1	0	0	0	0	0	0
$\vec{\rho}_2$	0	0	0	1	1	1	0	0	0
$\vec{\rho}_3$	0	0	0	0	0	0	1	1	1
$\vec{\rho}_4$	1	0	0	1	0	0	1	0	0
$\vec{\rho}_5$	0	1	0	0	1	0	0	1	0
$\vec{\rho}_6$	0	0	1	0	0	1	0	0	1
$\vec{\rho}_7$	1	0	0	0	1	0	0	0	1
$\vec{\rho}_8$	0	0	1	0	1	0	1	0	0

	1	2	3	4	5	6	7	8	9	10	11	12	13	14	15	16
$\vec{\rho}_1$	1	1	1	1	0	0	0	0	0	0	0	0	0	0	0	0
$\vec{\rho}_2$	0	0	0	0	1	1	1	1	0	0	0	0	0	0	0	0
$\vec{\rho}_3$	0	0	0	0	0	0	0	0	1	1	1	1	0	0	0	0
$\vec{\rho}_4$	0	0	0	0	0	0	0	0	0	0	0	0	1	1	1	1
$\vec{\rho}_5$	1	0	0	0	1	0	0	0	1	0	0	0	1	0	0	0
$\vec{\rho}_6$	0	1	0	0	0	1	0	0	0	1	0	0	0	1	0	0
$\vec{\rho}_7$	0	0	1	0	0	0	1	0	0	0	1	0	0	0	1	0
$\vec{\rho}_8$	0	0	0	1	0	0	0	1	0	0	0	1	0	0	0	1
$\vec{\rho}_9$	1	0	0	0	0	1	0	0	0	0	1	0	0	0	0	1
$\vec{\rho}_{10}$	0	0	0	1	0	0	1	0	0	1	0	0	1	0	0	0

We want to show that the rank of the matrix of coefficients, the number of rows in a maximal linearly independent set, is  $2n + 1$ . The first  $n$  rows of the matrix of coefficients add to the same vector as the second  $n$  rows, the vector of all ones. So a maximal linearly independent must omit at least one row. We will show that the set of all rows but the first  $\{\vec{\rho}_2 \dots \vec{\rho}_{2n+2}\}$  is linearly independent. So consider this linear relationship.

$$c_2\vec{\rho}_2 + \dots + c_{2n}\vec{\rho}_{2n} + c_{2n+1}\vec{\rho}_{2n+1} + c_{2n+2}\vec{\rho}_{2n+2} = \vec{0} \quad (*)$$

Now it gets messy. In the final two rows, in the first  $n$  columns, is a subrow that is all zeros except that it starts with a one in column 1 and a subrow that is all zeros except that it ends with a one in column  $n$ . With  $\vec{\rho}_1$  not in  $(*)$ , each of those columns contains only two ones and so we can conclude that  $c_{2n+1} = -c_{n+1}$  as well as that  $c_{2n+2} = -c_{2n}$ .

Next consider the columns between those two—in the  $n = 3$  illustration above this includes only the second column while in the  $n = 4$  matrix it includes both the second and third columns. Each such column has a single one. That is, for each column index  $j \in \{2 \dots n - 2\}$  the column consists of only zeros except for a one in row  $n + j$ , and hence  $c_{n+j} = 0$ .

On to the next block of columns, from  $n + 1$  through  $2n$ . Column  $n + 1$  has only two ones (because  $n \geq 3$  the ones in the last two rows do not fall in the first column of this block). Thus  $c_2 = -c_{n+1}$  and therefore  $c_2 = c_{2n+1}$ . Likewise, from column  $2n$  we conclude that  $c_2 = -c_{2n}$  and so  $c_2 = c_{2n+2}$ .

Because  $n \geq 3$  there is at least one column between column  $n + 1$  and column  $2n - 1$ . In at least one of those columns a one appears in  $\vec{\rho}_{2n+1}$ . If a one also appears in that column in  $\vec{\rho}_{2n+2}$  then we have  $c_2 = -(c_{2n+1} + c_{2n+2})$  (recall that  $c_{n+j} = 0$  for  $j \in \{2 \dots n - 2\}$ ). If a one does not appear in that column in  $\vec{\rho}_{2n+2}$  then we have  $c_2 = -c_{2n+1}$ . In either case  $c_2 = 0$ , and thus  $c_{2n+1} = c_{2n+2} = 0$  and  $c_{n+1} = c_{2n} = 0$ .

If the next block of  $n$ -many columns is not the last then similarly conclude from its first column that  $c_3 = c_{n+1} = 0$ .

Keep this up until we reach the last block of columns, those numbered  $(n - 1)n + 1$  through  $n^2$ . Because  $c_{n+1} = \dots = c_{2n} = 0$  column  $n^2$  gives that  $c_n = -c_{2n+1} = 0$ .

Therefore the rank of the matrix is  $2n + 1$ , as required.

The classic source on normal magic squares is [Ball & Coxeter]. More on the Lo Shu square is at [Wikipedia Lo Shu Square]. The proof given here began with [Ward].

### Exercises

- 1 Let  $M$  be a  $3 \times 3$  magic square with magic number  $s$ .
  - (a) Prove that the sum of  $M$ 's entries is  $3s$ .
  - (b) Prove that  $s = 3 \cdot m_{2,2}$ .
  - (c) Prove that  $m_{2,2}$  is the average of the entries in its row, its column, and in each diagonal.

- (d) Prove that  $m_{2,2}$  is the median of  $M$ 's entries.
- 2 Solve the system  $a + b = s$ ,  $c + d = s$ ,  $a + c = s$ ,  $b + d = s$ ,  $a + d = s$ , and  $b + c = s$ .
- 3 Show that  $\dim \mathcal{M}_{2,0} = 0$ .
- 4 Let the *trace* function be  $\text{Tr}(M) = m_{1,1} + \cdots + m_{n,n}$ . Define also the sum down the other diagonal  $\text{Tr}^*(M) = m_{1,n} + \cdots + m_{n,1}$ .
- (a) Show that the two functions  $\text{Tr}, \text{Tr}^*: \mathcal{M}_{n \times n} \rightarrow \mathbb{R}$  are linear.
- (b) Show that the function  $\theta: \mathcal{M}_{n \times n} \rightarrow \mathbb{R}^2$  given by  $\theta(M) = (\text{Tr}(M), \text{Tr}^*(M))$  is linear.
- (c) Generalize the prior item.
- 5 A square matrix is *semimagic* if the rows and columns add to the same value, that is, if we drop the condition on the diagonals.
- (a) Show that the set of semimagic squares  $\mathcal{H}_n$  is a subspace of  $\mathcal{M}_{n \times n}$ .
- (b) Show that the set  $\mathcal{H}_{n,0}$  of  $n \times n$  semimagic squares with magic number 0 is also a subspace of  $\mathcal{M}_{n \times n}$ .
- 6 [Beardon] Here is a slicker proof of the result of this Topic, when  $n \geq 3$ . See the prior two exercises for some definitions and needed results.
- (a) First show that  $\dim \mathcal{M}_{n,0} = \dim \mathcal{H}_{n,0} + 2$ . To do this, consider the function  $\theta: \mathcal{M}_n \rightarrow \mathbb{R}^2$  sending a matrix  $M$  to the ordered pair  $(\text{Tr}(M), \text{Tr}^*(M))$ . Specifically, consider the restriction of that map  $\theta: \mathcal{H}_n \rightarrow \mathbb{R}^2$  to the semimagic squares. Clearly its nullspace is  $\mathcal{M}_{n,0}$ . Show that when  $n \geq 3$  this restriction  $\theta$  is onto. (*Hint*: we need only find a basis for  $\mathbb{R}^2$  that is the image of two members of  $\mathcal{H}_n$ )
- (b) Let the function  $\phi: \mathcal{M}_{n \times n} \rightarrow \mathcal{M}_{(n-1) \times (n-1)}$  be the identity map except that it drops the final row and column:  $\phi(M) = \tilde{M}$  where  $\tilde{m}_{i,j} = m_{i,j}$  for all  $i, j \in \{1 \dots n-1\}$ . The check that  $\phi$  is linear is easy. Consider  $\phi$ 's restriction to the semimagic squares with magic number zero  $\phi: \mathcal{H}_{n,0} \rightarrow \mathcal{M}_{(n-1) \times (n-1)}$ . Show that  $\phi$  is one-to-one
- (c) Show that  $\phi$  is onto.
- (d) Conclude that  $\mathcal{H}_{n,0}$  has dimension  $(n-1)^2$ .
- (e) Conclude that  $\dim(\mathcal{M}_n) = n^2 - n$

## Markov Chains

Here is a simple game: a player bets on coin tosses, a dollar each time, and the game ends either when the player has no money or is up to five dollars. If the player starts with three dollars, what is the chance that the game takes at least five flips? Twenty-five flips?

At any point, this player has either \$0, or \$1, . . . , or \$5. We say that the player is in the *state*  $s_0, s_1, \dots, \text{ or } s_5$ . In the game the player moves from state to state. For instance, a player now in state  $s_3$  has on the next flip a 0.5 chance of moving to state  $s_2$  and a 0.5 chance of moving to  $s_4$ . The boundary states are a bit different; a player never leaves state  $s_0$  or state  $s_5$ .

Let  $p_i(n)$  be the probability that the player is in state  $s_i$  after  $n$  flips. Then, for instance, we have that the probability of being in state  $s_0$  after flip  $n + 1$  is  $p_0(n + 1) = p_0(n) + 0.5 \cdot p_1(n)$ . This matrix equation summarizes.

$$\begin{pmatrix} 1.0 & 0.5 & 0.0 & 0.0 & 0.0 & 0.0 \\ 0.0 & 0.0 & 0.5 & 0.0 & 0.0 & 0.0 \\ 0.0 & 0.5 & 0.0 & 0.5 & 0.0 & 0.0 \\ 0.0 & 0.0 & 0.5 & 0.0 & 0.5 & 0.0 \\ 0.0 & 0.0 & 0.0 & 0.5 & 0.0 & 0.0 \\ 0.0 & 0.0 & 0.0 & 0.0 & 0.5 & 1.0 \end{pmatrix} \begin{pmatrix} p_0(n) \\ p_1(n) \\ p_2(n) \\ p_3(n) \\ p_4(n) \\ p_5(n) \end{pmatrix} = \begin{pmatrix} p_0(n+1) \\ p_1(n+1) \\ p_2(n+1) \\ p_3(n+1) \\ p_4(n+1) \\ p_5(n+1) \end{pmatrix}$$

With the initial condition that the player starts with three dollars, these are components of the resulting vectors.

n = 0	n = 1	n = 2	n = 3	n = 4	...	n = 24
0	0	0	0.125	0.125		0.39600
0	0	0.25	0	0.1875		0.00276
0	0.5	0	0.375	0		0
1	0	0.5	0	0.3125		0.00447
0	0.5	0	0.25	0		0
0	0	0.25	0.25	0.375		0.59676

This exploration suggests that the game is not likely to go on for long, with the player quickly moving to an ending state. For instance, after the fourth flip there is a 0.50 probability that the game is already over.

This is a *Markov chain*, named for A. A. Markov, who worked in the first half of the 1900's. Each vector is a *probability vector*, whose entries are nonnegative real numbers that sum to 1. The matrix is a *transition matrix* or *stochastic matrix*, whose entries are nonnegative reals and whose columns sum to 1.

A characteristic feature of a Markov chain model is that it is *historyless* in that the next state depends only on the current state, not on any prior ones. Thus, a player who arrives at  $s_2$  by starting in state  $s_3$  and then going to state  $s_2$  has exactly the same chance of moving next to  $s_3$  as does a player whose history was to start in  $s_3$  then go to  $s_4$  then to  $s_3$  and then to  $s_2$ .

Here is a Markov chain from sociology. A study ([Macdonald & Ridge], p. 202) divided occupations in the United Kingdom into three levels: executives and professionals, supervisors and skilled manual workers, and unskilled workers. They asked about two thousand men, "At what level are you, and at what level was your father when you were fourteen years old?" Here the Markov model assumption about history may seem reasonable—we may guess that while a parent's occupation has a direct influence on the occupation of the child, the grandparent's occupation likely has no such direct influence. This summarizes the study's conclusions.

$$\begin{pmatrix} .60 & .29 & .16 \\ .26 & .37 & .27 \\ .14 & .34 & .57 \end{pmatrix} \begin{pmatrix} p_U(n) \\ p_M(n) \\ p_L(n) \end{pmatrix} = \begin{pmatrix} p_U(n+1) \\ p_M(n+1) \\ p_L(n+1) \end{pmatrix}$$

For instance, looking at the middle class for the next generation, a child of an upper class worker has a 0.26 probability of becoming middle class, a child of a middle class worker has a 0.37 chance of being middle class, and a child of a lower class worker has a 0.27 probability of becoming middle class. With the initial distribution of the respondent's fathers given below, this table gives the next five generations.

n = 0	n = 1	n = 2	n = 3	n = 4	n = 5
.12	.23	.29	.31	.32	.33
.32	.34	.34	.34	.33	.33
.56	.42	.37	.35	.34	.34

One more example. In professional American baseball there are two leagues, the American League and the National League. At the end of the annual season the team winning the American League and the team winning the National League play the World Series. The winner is the first team to take four games. That means that a series is in one of twenty-four states: 0-0 (no games won yet by either team), 1-0 (one game won for the American League team and no games for the National League team), etc.

Consider a series with a probability  $p$  that the American League team wins



each game. We have this.

$$\begin{pmatrix} 0 & 0 & 0 & 0 & \dots \\ p & 0 & 0 & 0 & \dots \\ 1-p & 0 & 0 & 0 & \dots \\ 0 & p & 0 & 0 & \dots \\ 0 & 1-p & p & 0 & \dots \\ 0 & 0 & 1-p & 0 & \dots \\ \vdots & \vdots & \vdots & \vdots & \ddots \end{pmatrix} \begin{pmatrix} p_{0-0}(n) \\ p_{1-0}(n) \\ p_{0-1}(n) \\ p_{2-0}(n) \\ p_{1-1}(n) \\ p_{0-2}(n) \\ \vdots \end{pmatrix} = \begin{pmatrix} p_{0-0}(n+1) \\ p_{1-0}(n+1) \\ p_{0-1}(n+1) \\ p_{2-0}(n+1) \\ p_{1-1}(n+1) \\ p_{0-2}(n+1) \\ \vdots \end{pmatrix}$$

An especially interesting special case is when the teams are evenly matched,  $p = 0.50$ . This table below lists the resulting components of the  $n = 0$  through  $n = 7$  vectors. (The code to generate this table in the computer algebra system Octave follows the exercises.)

Note that evenly-matched teams are likely to have a long series — there is a probability of 0.625 that the series goes at least six games.

	n = 0	n = 1	n = 2	n = 3	n = 4	n = 5	n = 6	n = 7
0-0	1	0	0	0	0	0	0	0
1-0	0	0.5	0	0	0	0	0	0
0-1	0	0.5	0	0	0	0	0	0
2-0	0	0	0.25	0	0	0	0	0
1-1	0	0	0.5	0	0	0	0	0
0-2	0	0	0.25	0	0	0	0	0
3-0	0	0	0	0.125	0	0	0	0
2-1	0	0	0	0.375	0	0	0	0
1-2	0	0	0	0.375	0	0	0	0
0-3	0	0	0	0.125	0	0	0	0
4-0	0	0	0	0	0.0625	0.0625	0.0625	0.0625
3-1	0	0	0	0	0.25	0	0	0
2-2	0	0	0	0	0.375	0	0	0
1-3	0	0	0	0	0.25	0	0	0
0-4	0	0	0	0	0.0625	0.0625	0.0625	0.0625
4-1	0	0	0	0	0	0.125	0.125	0.125
3-2	0	0	0	0	0	0.3125	0	0
2-3	0	0	0	0	0	0.3125	0	0
1-4	0	0	0	0	0	0.125	0.125	0.125
4-2	0	0	0	0	0	0	0.15625	0.15625
3-3	0	0	0	0	0	0	0.3125	0
2-4	0	0	0	0	0	0	0.15625	0.15625
4-3	0	0	0	0	0	0	0	0.15625
3-4	0	0	0	0	0	0	0	0.15625

Markov chains are a widely-used applications of matrix operations. They also give us an example of the use of matrices where we do not consider the significance of the maps represented by the matrices. For more on Markov chains, there are many sources such as [Kemeny & Snell] and [Iosifescu].

## Exercises

Use a computer for these problems. You can, for instance, adapt the Octave script given below.

- 1 These questions refer to the coin-flipping game.
  - (a) Check the computations in the table at the end of the first paragraph.
  - (b) Consider the second row of the vector table. Note that this row has alternating 0's. Must  $p_1(j)$  be 0 when  $j$  is odd? Prove that it must be, or produce a counterexample.
  - (c) Perform a computational experiment to estimate the chance that the player ends at five dollars, starting with one dollar, two dollars, and four dollars.
- 2 [Feller] We consider throws of a die, and say the system is in state  $s_i$  if the largest number yet appearing on the die was  $i$ .
  - (a) Give the transition matrix.
  - (b) Start the system in state  $s_1$ , and run it for five throws. What is the vector at the end?
- 3 [Kelton] There has been much interest in whether industries in the United States are moving from the Northeast and North Central regions to the South and West, motivated by the warmer climate, by lower wages, and by less unionization. Here is the transition matrix for large firms in Electric and Electronic Equipment.

	<i>NE</i>	<i>NC</i>	<i>S</i>	<i>W</i>	<i>Z</i>
<i>NE</i>	$\left( \begin{array}{c} 0.787 \\ 0 \\ 0 \\ 0 \\ 0.021 \end{array} \right)$	$\left( \begin{array}{c} 0 \\ 0.966 \\ 0.063 \\ 0 \\ 0.009 \end{array} \right)$	$\left( \begin{array}{c} 0 \\ 0.034 \\ 0.937 \\ 0.074 \\ 0.005 \end{array} \right)$	$\left( \begin{array}{c} 0.111 \\ 0 \\ 0 \\ 0.612 \\ 0.010 \end{array} \right)$	$\left( \begin{array}{c} 0.102 \\ 0 \\ 0 \\ 0.314 \\ 0.954 \end{array} \right)$

For example, a firm in the Northeast region will be in the West region next year with probability 0.111. (The  $Z$  entry is a "birth-death" state. For instance, with probability 0.102 a large Electric and Electronic Equipment firm from the Northeast will move out of this system next year: go out of business, move abroad, or move to another category of firm. There is a 0.021 probability that a firm in the *National Census of Manufacturers* will move into Electronics, or be created, or move in from abroad, into the Northeast. Finally, with probability 0.954 a firm out of the categories will stay out, according to this research.)

- (a) Does the Markov model assumption of lack of history seem justified?
- (b) Assume that the initial distribution is even, except that the value at  $Z$  is 0.9. Compute the vectors for  $n = 1$  through  $n = 4$ .
- (c) Suppose that the initial distribution is this.

<i>NE</i>	<i>NC</i>	<i>S</i>	<i>W</i>	<i>Z</i>
0.0000	0.6522	0.3478	0.0000	0.0000

Calculate the distributions for  $n = 1$  through  $n = 4$ .

- (d) Find the distribution for  $n = 50$  and  $n = 51$ . Has the system settled down to an equilibrium?
- 4 [Wickens] Here is a model of some kinds of learning. The learner starts in an undecided state  $s_U$ . Eventually the learner has to decide to do either response A (that is, end in state  $s_A$ ) or response B (ending in  $s_B$ ). However, the learner doesn't jump right from undecided to sure that A is the correct thing to do (or B). Instead, the learner spends some time in a "tentative-A" state, or a "tentative-B" state, trying the response out (denoted here  $t_A$  and  $t_B$ ). Imagine that once the learner has

decided, it is final, so once in  $s_A$  or  $s_B$ , the learner stays there. For the other state changes, we can posit transitions with probability  $p$  in either direction.

- (a) Construct the transition matrix.
  - (b) Take  $p = 0.25$  and take the initial vector to be 1 at  $s_U$ . Run this for five steps. What is the chance of ending up at  $s_A$ ?
  - (c) Do the same for  $p = 0.20$ .
  - (d) Graph  $p$  versus the chance of ending at  $s_A$ . Is there a threshold value for  $p$ , above which the learner is almost sure not to take longer than five steps?
- 5 A certain town is in a certain country (this is a hypothetical problem). Each year ten percent of the town dwellers move to other parts of the country. Each year one percent of the people from elsewhere move to the town. Assume that there are two states  $s_T$ , living in town, and  $s_C$ , living elsewhere.
- (a) Construct the transition matrix.
  - (b) Starting with an initial distribution  $s_T = 0.3$  and  $s_C = 0.7$ , get the results for the first ten years.
  - (c) Do the same for  $s_T = 0.2$ .
  - (d) Are the two outcomes alike or different?
- 6 For the World Series application, use a computer to generate the seven vectors for  $p = 0.55$  and  $p = 0.6$ .
- (a) What is the chance of the National League team winning it all, even though they have only a probability of 0.45 or 0.40 of winning any one game?
  - (b) Graph the probability  $p$  against the chance that the American League team wins it all. Is there a threshold value—a  $p$  above which the better team is essentially ensured of winning?
- 7 Above we define a transition matrix to have each entry nonnegative and each column sum to 1.
- (a) Check that the three transition matrices shown in this Topic meet these two conditions. Must any transition matrix do so?
  - (b) Observe that if  $A\vec{v}_0 = \vec{v}_1$  and  $A\vec{v}_1 = \vec{v}_2$  then  $A^2$  is a transition matrix from  $\vec{v}_0$  to  $\vec{v}_2$ . Show that a power of a transition matrix is also a transition matrix.
  - (c) Generalize the prior item by proving that the product of two appropriately-sized transition matrices is a transition matrix.

### Computer Code

This script *markov.m* for the computer algebra system Octave generated the table of World Series outcomes. (The hash character # marks the rest of a line as a comment.)

```
# Octave script file to compute chance of World Series outcomes.
function w = markov(p,v)
  q = 1-p;
  A=[0,0,0,0,0,0, 0,0,0,0,0,0, 0,0,0,0,0,0, 0,0,0,0,0,0; # 0-0
    p,0,0,0,0,0, 0,0,0,0,0,0, 0,0,0,0,0,0, 0,0,0,0,0,0; # 1-0
    q,0,0,0,0,0, 0,0,0,0,0,0, 0,0,0,0,0,0, 0,0,0,0,0,0; # 0-1
    0,p,0,0,0,0, 0,0,0,0,0,0, 0,0,0,0,0,0, 0,0,0,0,0,0; # 2-0
    0,q,p,0,0,0, 0,0,0,0,0,0, 0,0,0,0,0,0, 0,0,0,0,0,0; # 1-1
    0,0,q,0,0,0, 0,0,0,0,0,0, 0,0,0,0,0,0, 0,0,0,0,0,0; # 0-2
    0,0,0,p,0,0, 0,0,0,0,0,0, 0,0,0,0,0,0, 0,0,0,0,0,0; # 3-0
    0,0,0,q,p,0, 0,0,0,0,0,0, 0,0,0,0,0,0, 0,0,0,0,0,0; # 2-1
    0,0,0,0,q,p, 0,0,0,0,0,0, 0,0,0,0,0,0, 0,0,0,0,0,0; # 1-2
    0,0,0,0,0,q, 0,0,0,0,0,0, 0,0,0,0,0,0, 0,0,0,0,0,0; # 0-3
    0,0,0,0,0,0, p,0,0,0,1,0, 0,0,0,0,0,0, 0,0,0,0,0,0; # 4-0
    0,0,0,0,0,0, q,p,0,0,0,0, 0,0,0,0,0,0, 0,0,0,0,0,0; # 3-1
    0,0,0,0,0,0, 0,q,p,0,0,0, 0,0,0,0,0,0, 0,0,0,0,0,0; # 2-2
    0,0,0,0,0,0, 0,0,q,p,0,0, 0,0,0,0,0,0, 0,0,0,0,0,0; # 1-3
```

```

0,0,0,0,0,0, 0,0,0,q,0,0, 0,0,1,0,0,0, 0,0,0,0,0,0; # 0-4_
0,0,0,0,0,0, 0,0,0,0,0,p, 0,0,0,1,0,0, 0,0,0,0,0,0; # 4-1
0,0,0,0,0,0, 0,0,0,0,0,q, p,0,0,0,0,0, 0,0,0,0,0,0; # 3-2
0,0,0,0,0,0, 0,0,0,0,0,0, q,p,0,0,0,0, 0,0,0,0,0,0; # 2-3_
0,0,0,0,0,0, 0,0,0,0,0,0, 0,q,0,0,0,0, 1,0,0,0,0,0; # 1-4
0,0,0,0,0,0, 0,0,0,0,0,0, 0,0,0,0,p,0, 0,1,0,0,0,0; # 4-2
0,0,0,0,0,0, 0,0,0,0,0,0, 0,0,0,0,q,p, 0,0,0,0,0,0; # 3-3_
0,0,0,0,0,0, 0,0,0,0,0,0, 0,0,0,0,q, 0,0,0,1,0,0; # 2-4
0,0,0,0,0,0, 0,0,0,0,0,0, 0,0,0,0,0,0, 0,0,p,0,1,0; # 4-3
0,0,0,0,0,0, 0,0,0,0,0,0, 0,0,0,0,0,0, 0,0,q,0,0,1]; # 3-4
w = A * v;
endfunction

```

Then the Octave session was this.

```

> v0=[1;0;0;0;0;0;0;0;0;0;0;0;0;0;0;0;0]
> p=.5
> v1=markov(p,v0)
> v2=markov(p,v1)
...

```

Translating to another computer algebra system should be easy—all have commands similar to these.

## Orthonormal Matrices

In *The Elements*, Euclid considers two figures to be the same if they have the same size and shape. That is, while the triangles below are not equal because they are not the same set of points, they are *congruent*—essentially indistinguishable for Euclid’s purposes—because we can imagine picking the plane up, sliding it over and rotating it a bit, although not warping or stretching it, and then putting it back down, to superimpose the first figure on the second. (Euclid never explicitly states this principle but he uses it often [Casey].)

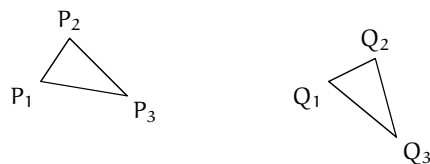

In modern terminology, “picking the plane up . . .” is considering a map from the plane to itself. Euclid considers only transformations of the plane that may slide or turn the plane but not bend or stretch it. Accordingly, we define a map  $f: \mathbb{R}^2 \rightarrow \mathbb{R}^2$  to be *distance-preserving* or a *rigid motion* or an *isometry*, if for all points  $P_1, P_2 \in \mathbb{R}^2$ , the distance from  $f(P_1)$  to  $f(P_2)$  equals the distance from  $P_1$  to  $P_2$ . We also define a plane *figure* to be a set of points in the plane and we say that two figures are *congruent* if there is a distance-preserving map from the plane to itself that carries one figure onto the other.

Many statements from Euclidean geometry follow easily from these definitions. Some are: (i) collinearity is invariant under any distance-preserving map (that is, if  $P_1, P_2$ , and  $P_3$  are collinear then so are  $f(P_1), f(P_2)$ , and  $f(P_3)$ ), (ii) betweenness is invariant under any distance-preserving map (if  $P_2$  is between  $P_1$  and  $P_3$  then so is  $f(P_2)$  between  $f(P_1)$  and  $f(P_3)$ ), (iii) the property of being a triangle is invariant under any distance-preserving map (if a figure is a triangle then the image of that figure is also a triangle), (iv) and the property of being a circle is invariant under any distance-preserving map. In 1872, F. Klein suggested that we can define Euclidean geometry as the study of properties that are invariant under these maps. (This forms part of Klein’s Erlanger Program, which proposes the organizing principle that we can describe each kind of geometry—Euclidean, projective, etc.—as the study of the properties that are

invariant under some group of transformations. The word ‘group’ here means more than just ‘collection’, but that lies outside of our scope.)

We can use linear algebra to characterize the distance-preserving maps of the plane.

We must first observe that there are distance-preserving transformations of the plane that are not linear. The obvious example is this *translation*.

$$\begin{pmatrix} x \\ y \end{pmatrix} \mapsto \begin{pmatrix} x \\ y \end{pmatrix} + \begin{pmatrix} 1 \\ 0 \end{pmatrix} = \begin{pmatrix} x+1 \\ y \end{pmatrix}$$

However, this example turns out to be the only example, in the sense that if  $f$  is distance-preserving and sends  $\vec{0}$  to  $\vec{v}_0$  then the map  $\vec{v} \mapsto f(\vec{v}) - \vec{v}_0$  is linear. That will follow immediately from this statement: a map  $t$  that is distance-preserving and sends  $\vec{0}$  to itself is linear. To prove this equivalent statement, let

$$t(\vec{e}_1) = \begin{pmatrix} a \\ b \end{pmatrix} \quad t(\vec{e}_2) = \begin{pmatrix} c \\ d \end{pmatrix}$$

for some  $a, b, c, d \in \mathbb{R}$ . Then to show that  $t$  is linear we can show that it can be represented by a matrix, that is, that  $t$  acts in this way for all  $x, y \in \mathbb{R}$ .

$$\vec{v} = \begin{pmatrix} x \\ y \end{pmatrix} \xrightarrow{t} \begin{pmatrix} ax + cy \\ bx + dy \end{pmatrix} \quad (*)$$

Recall that if we fix three non-collinear points then we can determine any point by giving its distance from those three. So we can determine any point  $\vec{v}$  in the domain by its distance from  $\vec{0}$ ,  $\vec{e}_1$ , and  $\vec{e}_2$ . Similarly, we can determine any point  $t(\vec{v})$  in the codomain by its distance from the three fixed points  $t(\vec{0})$ ,  $t(\vec{e}_1)$ , and  $t(\vec{e}_2)$  (these three are not collinear because, as mentioned above, collinearity is invariant and  $\vec{0}$ ,  $\vec{e}_1$ , and  $\vec{e}_2$  are not collinear). In fact, because  $t$  is distance-preserving, we can say more: for the point  $\vec{v}$  in the plane that is determined by being the distance  $d_0$  from  $\vec{0}$ , the distance  $d_1$  from  $\vec{e}_1$ , and the distance  $d_2$  from  $\vec{e}_2$ , its image  $t(\vec{v})$  must be the unique point in the codomain that is determined by being  $d_0$  from  $t(\vec{0})$ ,  $d_1$  from  $t(\vec{e}_1)$ , and  $d_2$  from  $t(\vec{e}_2)$ . Because of the uniqueness, checking that the action in  $(*)$  works in the  $d_0$ ,  $d_1$ , and  $d_2$  cases

$$\text{dist}\left(\begin{pmatrix} x \\ y \end{pmatrix}, \vec{0}\right) = \text{dist}\left(t\left(\begin{pmatrix} x \\ y \end{pmatrix}\right), t(\vec{0})\right) = \text{dist}\left(\begin{pmatrix} ax + cy \\ bx + dy \end{pmatrix}, \vec{0}\right)$$

(we assumed that  $t$  maps  $\vec{0}$  to itself)

$$\text{dist}\left(\begin{pmatrix} x \\ y \end{pmatrix}, \vec{e}_1\right) = \text{dist}\left(t\left(\begin{pmatrix} x \\ y \end{pmatrix}\right), t(\vec{e}_1)\right) = \text{dist}\left(\begin{pmatrix} ax + cy \\ bx + dy \end{pmatrix}, \begin{pmatrix} a \\ b \end{pmatrix}\right)$$

and

$$\text{dist}\left(\begin{pmatrix} x \\ y \end{pmatrix}, \vec{e}_2\right) = \text{dist}\left(t\left(\begin{pmatrix} x \\ y \end{pmatrix}\right), t(\vec{e}_2)\right) = \text{dist}\left(\begin{pmatrix} ax + cy \\ bx + dy \end{pmatrix}, \begin{pmatrix} c \\ d \end{pmatrix}\right)$$

suffices to show that (\*) describes  $t$ . Those checks are routine.

Thus we can write any distance-preserving  $f: \mathbb{R}^2 \rightarrow \mathbb{R}^2$  as  $f(\vec{v}) = t(\vec{v}) + \vec{v}_0$  for some constant vector  $\vec{v}_0$  and linear map  $t$  that is distance-preserving. So what is left in order to understand distance-preserving maps is to understand distance-preserving linear maps.

Not every linear map is distance-preserving. For example  $\vec{v} \mapsto 2\vec{v}$  does not preserve distances.

But there is a neat characterization: a linear transformation  $t$  of the plane is distance-preserving if and only if both  $\|t(\vec{e}_1)\| = \|t(\vec{e}_2)\| = 1$ , and  $t(\vec{e}_1)$  is orthogonal to  $t(\vec{e}_2)$ . The ‘only if’ half of that statement is easy—because  $t$  is distance-preserving it must preserve the lengths of vectors and because  $t$  is distance-preserving the Pythagorean theorem shows that it must preserve orthogonality. To show the ‘if’ half we can check that the map preserves lengths of vectors because then for all  $\vec{p}$  and  $\vec{q}$  the distance between the two is preserved  $\|t(\vec{p} - \vec{q})\| = \|t(\vec{p}) - t(\vec{q})\| = \|\vec{p} - \vec{q}\|$ . For that check let

$$\vec{v} = \begin{pmatrix} x \\ y \end{pmatrix} \quad t(\vec{e}_1) = \begin{pmatrix} a \\ b \end{pmatrix} \quad t(\vec{e}_2) = \begin{pmatrix} c \\ d \end{pmatrix}$$

and with the ‘if’ assumptions that  $a^2 + b^2 = c^2 + d^2 = 1$  and  $ac + bd = 0$  we have this.

$$\begin{aligned} \|t(\vec{v})\|^2 &= (ax + cy)^2 + (bx + dy)^2 \\ &= a^2x^2 + 2acxy + c^2y^2 + b^2x^2 + 2bdxy + d^2y^2 \\ &= x^2(a^2 + b^2) + y^2(c^2 + d^2) + 2xy(ac + bd) \\ &= x^2 + y^2 \\ &= \|\vec{v}\|^2 \end{aligned}$$

One thing that is neat about this characterization is that we can easily recognize matrices that represent such a map with respect to the standard bases: the columns are of length one and are mutually orthogonal. This is an *orthonormal matrix* or *orthogonal matrix* (people often use the second term to mean not just that the columns are orthogonal but also that they have length one).

We can use this to understand the geometric actions of distance-preserving maps. Because  $\|t(\vec{v})\| = \|\vec{v}\|$ , the map  $t$  sends any  $\vec{v}$  somewhere on the circle about the origin that has radius equal to the length of  $\vec{v}$ . In particular,  $\vec{e}_1$  and  $\vec{e}_2$  map to the unit circle. What’s more, once we fix the unit vector  $\vec{e}_1$  as mapped to the vector with components  $a$  and  $b$  then there are only two places where  $\vec{e}_2$  can go if its image is to be perpendicular to the first vector’s image: it can map either to one where  $\vec{e}_2$  maintains its position a quarter circle clockwise from  $\vec{e}_1$

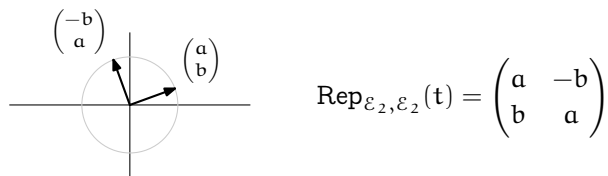

or to one where it goes a quarter circle counterclockwise.

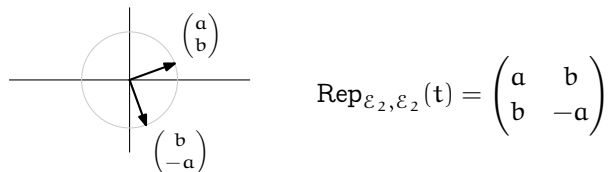

We can geometrically describe these two cases. Let  $\theta$  be the counterclockwise angle between the  $x$ -axis and the image of  $\vec{e}_1$ . The first matrix above represents, with respect to the standard bases, a *rotation* of the plane by  $\theta$  radians.

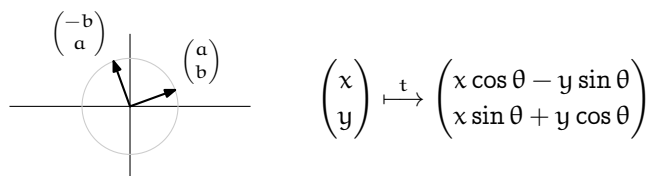

The second matrix above represents a *reflection* of the plane through the line bisecting the angle between  $\vec{e}_1$  and  $t(\vec{e}_1)$ .

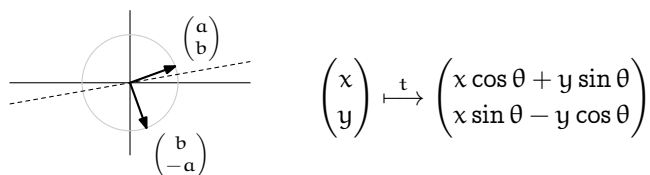

(This picture shows  $\vec{e}_1$  reflected up into the first quadrant and  $\vec{e}_2$  reflected down into the fourth quadrant.)

Note: in the domain the angle between  $\vec{e}_1$  and  $\vec{e}_2$  runs counterclockwise, and in the first map above the angle from  $t(\vec{e}_1)$  to  $t(\vec{e}_2)$  is also counterclockwise, so it preserves the orientation of the angle. But the second map reverses the orientation. A distance-preserving map is *direct* if it preserves orientations and *opposite* if it reverses orientation.

So, we have characterized the Euclidean study of congruence. It considers, for plane figures, the properties that are invariant under combinations of (i) a rotation followed by a translation, or (ii) a reflection followed by a translation (a reflection followed by a non-trivial translation is a *glide reflection*).

Another idea, besides congruence of figures, encountered in elementary geometry is that figures are *similar* if they are congruent after a change of scale. These two triangles are similar since the second is the same shape as the first, but 3/2-ths the size.



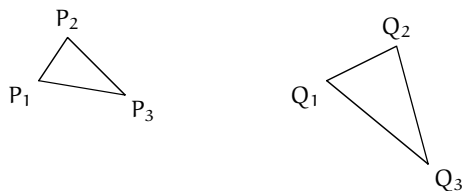

From the above work we have that figures are similar if there is an orthonormal matrix  $T$  such that the points  $\vec{q}$  on one figure are the images of the points  $\vec{p}$  on the other figure by  $\vec{q} = (kT)\vec{v} + \vec{p}_0$  for some nonzero real number  $k$  and constant vector  $\vec{p}_0$ .

Although these ideas are from Euclid, mathematics is timeless and they are still in use today. One application of the maps studied above is in computer graphics. We can, for example, animate this top view of a cube by putting together film frames of it rotating; that's a rigid motion.

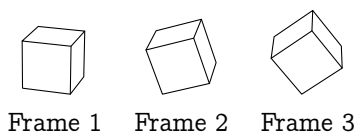

We could also make the cube appear to be moving away from us by producing film frames of it shrinking, which gives us figures that are similar.

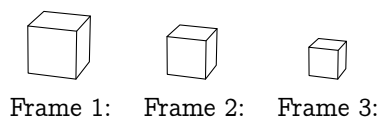

Computer graphics incorporates techniques from linear algebra in many other ways (see Exercise 4).

A beautiful book that explores some of this area is [Weyl]. More on groups, of transformations and otherwise, is in any book on Modern Algebra, for instance [Birkhoff & MacLane]. More on Klein and the Erlanger Program is in [Yaglom].

### Exercises

- Decide if each of these is an orthonormal matrix.
  - $\begin{pmatrix} 1/\sqrt{2} & -1/\sqrt{2} \\ -1/\sqrt{2} & -1/\sqrt{2} \end{pmatrix}$
  - $\begin{pmatrix} 1/\sqrt{3} & -1/\sqrt{3} \\ -1/\sqrt{3} & -1/\sqrt{3} \end{pmatrix}$
  - $\begin{pmatrix} 1/\sqrt{3} & -\sqrt{2}/\sqrt{3} \\ -\sqrt{2}/\sqrt{3} & -1/\sqrt{3} \end{pmatrix}$
- Write down the formula for each of these distance-preserving maps.
  - the map that rotates  $\pi/6$  radians, and then translates by  $\vec{e}_2$
  - the map that reflects about the line  $y = 2x$
  - the map that reflects about  $y = -2x$  and translates over 1 and up 1
- The proof that a map that is distance-preserving and sends the zero vector to itself incidentally shows that such a map is one-to-one and onto (the point in the domain determined by  $d_0$ ,  $d_1$ , and  $d_2$  corresponds to the point in the codomain determined by those three). Therefore any distance-preserving map has an inverse. Show that the inverse is also distance-preserving.

- (b) Prove that congruence is an equivalence relation between plane figures.
- 4 In practice the matrix for the distance-preserving linear transformation and the translation are often combined into one. Check that these two computations yield the same first two components.

$$\begin{pmatrix} a & c \\ b & d \end{pmatrix} \begin{pmatrix} x \\ y \end{pmatrix} + \begin{pmatrix} e \\ f \end{pmatrix} = \begin{pmatrix} a & c & e \\ b & d & f \\ 0 & 0 & 1 \end{pmatrix} \begin{pmatrix} x \\ y \\ 1 \end{pmatrix}$$

(These are *homogeneous coordinates*; see the Topic on Projective Geometry).

- 5 (a) Verify that the properties described in the second paragraph of this Topic as invariant under distance-preserving maps are indeed so.
- (b) Give two more properties that are of interest in Euclidean geometry from your experience in studying that subject that are also invariant under distance-preserving maps.
- (c) Give a property that is not of interest in Euclidean geometry and is not invariant under distance-preserving maps.

# Determinants

In the first chapter we highlighted the special case of linear systems with the same number of equations as unknowns, those of the form  $T\vec{x} = \vec{b}$  where  $T$  is a square matrix. We noted a distinction between two classes of  $T$ 's. If  $T$  is associated with a unique solution for any vector  $\vec{b}$  of constants, such as for the homogeneous system  $T\vec{x} = \vec{0}$ , then  $T$  is associated with a unique solution for every vector  $\vec{b}$ . We call such a matrix of coefficients nonsingular. The other kind of  $T$ , where every linear system for which it is the matrix of coefficients has either no solution or infinitely many solutions, is singular.

In our work since then the value of this distinction has been a theme. For instance, we now know that an  $n \times n$  matrix  $T$  is nonsingular if and only if each of these holds:

- any system  $T\vec{x} = \vec{b}$  has a solution and that solution is unique;
- Gauss-Jordan reduction of  $T$  yields an identity matrix;
- the rows of  $T$  form a linearly independent set;
- the columns of  $T$  form a linearly independent set, and a basis for  $\mathbb{R}^n$ ;
- any map that  $T$  represents is an isomorphism;
- an inverse matrix  $T^{-1}$  exists.

So when we look at a particular square matrix, one of the first things that we ask is whether it is nonsingular.

Naturally there is a formula that determines whether  $T$  is nonsingular. This chapter develops that formula. More precisely, we will develop infinitely many formulas, one for  $1 \times 1$  matrices, one for  $2 \times 2$  matrices, etc. These formulas are related, that is, we will develop a family of formulas, a scheme that describes the formula for each size.

Since we will restrict the discussion to square matrices, in this chapter we will often simply say 'matrix' in place of 'square matrix'.

## I Definition

Determining nonsingularity is trivial for  $1 \times 1$  matrices.

$$\begin{pmatrix} a \end{pmatrix} \text{ is nonsingular iff } a \neq 0$$

As part of our development of the method for computing matrix inverses, in Corollary Three.IV.4.11 we gave the formula for the inverse of a  $2 \times 2$  matrix.

$$\begin{pmatrix} a & b \\ c & d \end{pmatrix} \text{ is nonsingular iff } ad - bc \neq 0$$

We can produce the  $3 \times 3$  formula as we did the prior one, although the computation is intricate (see Exercise 9).

$$\begin{pmatrix} a & b & c \\ d & e & f \\ g & h & i \end{pmatrix} \text{ is nonsingular iff } aei + bfg + cdh - hfa - idb - gec \neq 0$$

With these cases in mind, we posit a family of formulas:  $a$ ,  $ad - bc$ , etc. For each  $n$  the formula gives rise to a *determinant* function  $\det_{n \times n}: \mathcal{M}_{n \times n} \rightarrow \mathbb{R}$  such that an  $n \times n$  matrix  $T$  is nonsingular if and only if  $\det_{n \times n}(T) \neq 0$ . (We usually omit the subscript  $n \times n$  because the size of  $T$  tells us which determinant function we mean.)

### I.1 Exploration

*This is an optional motivation of the general definition, suggesting how a person might develop that formula. The definition is in the next subsection.*

Above, in each case the matrix is nonsingular if and only if some formula is nonzero. But the three cases don't show an obvious pattern for the formula. We may spot that the  $1 \times 1$  term  $a$  has one letter, that the  $2 \times 2$  terms  $ad$  and  $bc$  have two letters, and that the  $3 \times 3$  terms  $aei$ , etc., have three letters. We may also spot that in those terms there is a letter from each row and column of the matrix, e.g., in the  $cdh$  term one letter comes from each row and from each column.

$$\begin{pmatrix} & c \\ d & h \end{pmatrix}$$

But these observations are perhaps more puzzling than enlightening. For instance, we might wonder why we add some of the terms while we subtract others.

A good problem solving strategy is to see what properties a solution must have and then search for something with those properties. So we shall start by asking what properties we require of the formulas.

At this point, our main way to decide whether a matrix is singular or nonsingular is to do Gaussian reduction and then check whether the diagonal of resulting echelon form matrix has any zeroes (that is, to check whether the product down the diagonal is zero). So we could guess that whatever formula we find, the proof that it is right may involve applying Gauss' method to the matrix to show that in the end the product down the diagonal is zero if and only if our formula gives zero.

This suggests a plan: we will look for a family of determinant formulas that are unaffected by row operations and such that the determinant of an echelon form matrix is the product of its diagonal entries. In the rest of this subsection we will test this plan against the  $2 \times 2$  and  $3 \times 3$  formulas. In the end we will have to modify the "unaffected by row operations" part, but not by much.

The first step in testing this plan is to see whether the  $2 \times 2$  and  $3 \times 3$  formulas are unaffected by the row operation of combining: if

$$T \xrightarrow{k\rho_i + \rho_j} \hat{T}$$

then is  $\det(\hat{T}) = \det(T)$ ? This check of the  $2 \times 2$  determinant after the  $k\rho_1 + \rho_2$  operation

$$\det\left(\begin{pmatrix} a & b \\ ka + c & kb + d \end{pmatrix}\right) = a(kb + d) - (ka + c)b = ad - bc$$

shows that it is indeed unchanged, and the other  $2 \times 2$  combination  $k\rho_2 + \rho_1$  gives the same result. The  $3 \times 3$  combination  $k\rho_3 + \rho_2$  leaves the determinant unchanged

$$\begin{aligned} \det\left(\begin{pmatrix} a & b & c \\ kg + d & kh + e & ki + f \\ g & h & i \end{pmatrix}\right) &= a(kh + e)i + b(ki + f)g + c(kg + d)h \\ &\quad - h(ki + f)a - i(kg + d)b - g(kh + e)c \\ &= aei + bfg + cdh - hfa - idb - gec \end{aligned}$$

as do the other  $3 \times 3$  row combination operations.

So there seems to be promise in the plan. Of course, perhaps if we had worked out the  $4 \times 4$  determinant formula and tested it then we might have found that it is affected by row combinations. This is an exploration and we do not yet have all the facts. Nonetheless, so far, so good.

Next is to compare  $\det(\hat{T})$  with  $\det(T)$  for row swaps. We now hit a snag: the  $2 \times 2$  row swap  $\rho_1 \leftrightarrow \rho_2$  does not yield  $ad - bc$ .

$$\det\left(\begin{pmatrix} c & d \\ a & b \end{pmatrix}\right) = cb - ad$$

And this  $\rho_1 \leftrightarrow \rho_3$  swap inside of a  $3 \times 3$  matrix

$$\det\left(\begin{pmatrix} g & h & i \\ d & e & f \\ a & b & c \end{pmatrix}\right) = gec + hfa + idb - bfg - cdh - aei$$

also does not give the same determinant as before the swap; again there is a sign change. Trying a different  $3 \times 3$  swap  $\rho_1 \leftrightarrow \rho_2$

$$\det \begin{pmatrix} d & e & f \\ a & b & c \\ g & h & i \end{pmatrix} = dbi + ecg + fah - hcd -iae - gbf$$

also gives a change of sign.

So row swaps seem to change the sign of a determinant formula. This does not wreck our plan entirely. We intend to decide nonsingularity by considering only whether the formula gives zero, not by considering its sign. Therefore, instead of expecting determinant formulas to be entirely unaffected by row operations, we modify our plan to have them to change sign on a swap.

To finish we compare  $\det(\hat{T})$  to  $\det(T)$  for the operation of multiplying a row by a scalar  $k \neq 0$ . This

$$\det \begin{pmatrix} a & b \\ kc & kd \end{pmatrix} = a(kd) - (kc)b = k \cdot (ad - bc)$$

ends with the determinant multiplied by  $k$ , and the other  $2 \times 2$  case has the same result. This  $3 \times 3$  case ends the same way

$$\begin{aligned} \det \begin{pmatrix} a & b & c \\ d & e & f \\ kg & kh & ki \end{pmatrix} &= ae(ki) + bf(kg) + cd(kh) \\ &\quad - (kh)fa - (ki)db - (kg)ec \\ &= k \cdot (aei + bfg + cdh - hfa - idb - gec) \end{aligned}$$

and the other two are similar. These make us suspect that multiplying a row by  $k$  multiplies the determinant by  $k$ . As before, this modifies our plan but does not wreck it. We are asking only that the zeroness of the determinant formula be unchanged and we are not focusing on the its sign or magnitude.

So, our modified plan is to look for determinants that remain unchanged under the operation of row combination, that change sign on a row swap, and that rescale on the rescaling of a row. In the next two subsections we will find that for each  $n$  there is such a function, and is unique.

For the next subsection, note that scalars factor out of a row without affecting other rows: here

$$\det \begin{pmatrix} 3 & 3 & 9 \\ 2 & 1 & 1 \\ 5 & 10 & -5 \end{pmatrix} = 3 \cdot \det \begin{pmatrix} 1 & 1 & 3 \\ 2 & 1 & 1 \\ 5 & 10 & -5 \end{pmatrix}$$

the 3 comes only out of the top row only, leaving the other rows unchanged. So in the definition of determinant we will write it as a function of the rows  $\det(\vec{\rho}_1, \vec{\rho}_2, \dots, \vec{\rho}_n)$ , not as  $\det(T)$  or as a function of the entries  $\det(t_{1,1}, \dots, t_{n,n})$ .

### Exercises

✓ 1.1 Evaluate the determinant of each.

$$(a) \begin{pmatrix} 3 & 1 \\ -1 & 1 \end{pmatrix} \quad (b) \begin{pmatrix} 2 & 0 & 1 \\ 3 & 1 & 1 \\ -1 & 0 & 1 \end{pmatrix} \quad (c) \begin{pmatrix} 4 & 0 & 1 \\ 0 & 0 & 1 \\ 1 & 3 & -1 \end{pmatrix}$$

1.2 Evaluate the determinant of each.

$$(a) \begin{pmatrix} 2 & 0 \\ -1 & 3 \end{pmatrix} \quad (b) \begin{pmatrix} 2 & 1 & 1 \\ 0 & 5 & -2 \\ 1 & -3 & 4 \end{pmatrix} \quad (c) \begin{pmatrix} 2 & 3 & 4 \\ 5 & 6 & 7 \\ 8 & 9 & 1 \end{pmatrix}$$

✓ 1.3 Verify that the determinant of an upper-triangular  $3 \times 3$  matrix is the product down the diagonal.

$$\det \begin{pmatrix} a & b & c \\ 0 & e & f \\ 0 & 0 & i \end{pmatrix} = aei$$

Do lower-triangular matrices work the same way?

✓ 1.4 Use the determinant to decide if each is singular or nonsingular.

$$(a) \begin{pmatrix} 2 & 1 \\ 3 & 1 \end{pmatrix} \quad (b) \begin{pmatrix} 0 & 1 \\ 1 & -1 \end{pmatrix} \quad (c) \begin{pmatrix} 4 & 2 \\ 2 & 1 \end{pmatrix}$$

1.5 Singular or nonsingular? Use the determinant to decide.

$$(a) \begin{pmatrix} 2 & 1 & 1 \\ 3 & 2 & 2 \\ 0 & 1 & 4 \end{pmatrix} \quad (b) \begin{pmatrix} 1 & 0 & 1 \\ 2 & 1 & 1 \\ 4 & 1 & 3 \end{pmatrix} \quad (c) \begin{pmatrix} 2 & 1 & 0 \\ 3 & -2 & 0 \\ 1 & 0 & 0 \end{pmatrix}$$

✓ 1.6 Each pair of matrices differ by one row operation. Use this operation to compare  $\det(A)$  with  $\det(B)$ .

$$(a) A = \begin{pmatrix} 1 & 2 \\ 2 & 3 \end{pmatrix} \quad B = \begin{pmatrix} 1 & 2 \\ 0 & -1 \end{pmatrix}$$

$$(b) A = \begin{pmatrix} 3 & 1 & 0 \\ 0 & 0 & 1 \\ 0 & 1 & 2 \end{pmatrix} \quad B = \begin{pmatrix} 3 & 1 & 0 \\ 0 & 1 & 2 \\ 0 & 0 & 1 \end{pmatrix}$$

$$(c) A = \begin{pmatrix} 1 & -1 & 3 \\ 2 & 2 & -6 \\ 1 & 0 & 4 \end{pmatrix} \quad B = \begin{pmatrix} 1 & -1 & 3 \\ 1 & 1 & -3 \\ 1 & 0 & 4 \end{pmatrix}$$

1.7 Show this.

$$\det \begin{pmatrix} 1 & 1 & 1 \\ a & b & c \\ a^2 & b^2 & c^2 \end{pmatrix} = (b-a)(c-a)(c-b)$$

✓ 1.8 Which real numbers  $x$  make this matrix singular?

$$\begin{pmatrix} 12-x & 4 \\ 8 & 8-x \end{pmatrix}$$

1.9 Do the Gaussian reduction to check the formula for  $3 \times 3$  matrices stated in the preamble to this section.

$$\begin{pmatrix} a & b & c \\ d & e & f \\ g & h & i \end{pmatrix} \text{ is nonsingular iff } aei + bfg + cdh - hfa - idb - gec \neq 0$$

1.10 Show that the equation of a line in  $\mathbb{R}^2$  thru  $(x_1, y_1)$  and  $(x_2, y_2)$  is given by this determinant.

$$\det \begin{pmatrix} x & y & 1 \\ x_1 & y_1 & 1 \\ x_2 & y_2 & 1 \end{pmatrix} = 0 \quad x_1 \neq x_2$$

- ✓ 1.11 Many people know this mnemonic for the determinant of a  $3 \times 3$  matrix: first repeat the first two columns and then sum the products on the forward diagonals and subtract the products on the backward diagonals. That is, first write

$$\begin{pmatrix} h_{1,1} & h_{1,2} & h_{1,3} & | & h_{1,1} & h_{1,2} \\ h_{2,1} & h_{2,2} & h_{2,3} & | & h_{2,1} & h_{2,2} \\ h_{3,1} & h_{3,2} & h_{3,3} & | & h_{3,1} & h_{3,2} \end{pmatrix}$$

and then calculate this.

$$h_{1,1}h_{2,2}h_{3,3} + h_{1,2}h_{2,3}h_{3,1} + h_{1,3}h_{2,1}h_{3,2} \\ - h_{3,1}h_{2,2}h_{1,3} - h_{3,2}h_{2,3}h_{1,1} - h_{3,3}h_{2,1}h_{1,2}$$

- (a) Check that this agrees with the formula given in the preamble to this section.  
 (b) Does it extend to other-sized determinants?

1.12 The *cross product* of the vectors

$$\vec{x} = \begin{pmatrix} x_1 \\ x_2 \\ x_3 \end{pmatrix} \quad \vec{y} = \begin{pmatrix} y_1 \\ y_2 \\ y_3 \end{pmatrix}$$

is the vector computed as this determinant.

$$\vec{x} \times \vec{y} = \det \begin{pmatrix} \vec{e}_1 & \vec{e}_2 & \vec{e}_3 \\ x_1 & x_2 & x_3 \\ y_1 & y_2 & y_3 \end{pmatrix}$$

Note that the first row's entries are vectors, the vectors from the standard basis for  $\mathbb{R}^3$ . Show that the cross product of two vectors is perpendicular to each vector.

1.13 Prove that each statement holds for  $2 \times 2$  matrices.

- (a) The determinant of a product is the product of the determinants  $\det(ST) = \det(S) \cdot \det(T)$ .  
 (b) If  $T$  is invertible then the determinant of the inverse is the inverse of the determinant  $\det(T^{-1}) = (\det(T))^{-1}$ .

Matrices  $T$  and  $T'$  are *similar* if there is a nonsingular matrix  $P$  such that  $T' = PTP^{-1}$ . (This definition is in Chapter Five.) Show that similar  $2 \times 2$  matrices have the same determinant.

- ✓ 1.14 Prove that the area of this region in the plane

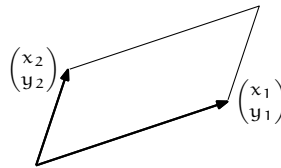

is equal to the value of this determinant.

$$\det \begin{pmatrix} x_1 & x_2 \\ y_1 & y_2 \end{pmatrix}$$

Compare with this.

$$\det \begin{pmatrix} x_2 & x_1 \\ y_2 & y_1 \end{pmatrix}$$

- 1.15 Prove that for  $2 \times 2$  matrices, the determinant of a matrix equals the determinant of its transpose. Does that also hold for  $3 \times 3$  matrices?  
 ✓ 1.16 Is the determinant function linear — is  $\det(x \cdot T + y \cdot S) = x \cdot \det(T) + y \cdot \det(S)$ ?  
 1.17 Show that if  $A$  is  $3 \times 3$  then  $\det(c \cdot A) = c^3 \cdot \det(A)$  for any scalar  $c$ .



1.18 Which real numbers  $\theta$  make

$$\begin{pmatrix} \cos \theta & -\sin \theta \\ \sin \theta & \cos \theta \end{pmatrix}$$

singular? Explain geometrically.

? 1.19 [Am. Math. Mon., Apr. 1955] If a third order determinant has elements 1, 2, ..., 9, what is the maximum value it may have?

## I.2 Properties of Determinants

We want a formula to determine whether an  $n \times n$  matrix is nonsingular. We will not begin by stating such a formula. Instead, we will begin by considering the function that such a formula calculates. We will define this function by its properties, then prove that the function with these properties exist and is unique, and also describe formulas that compute this function. (Because we will eventually show that the function exists and is unique, from the start we will say 'det(T)' instead of 'if there is a unique determinant function then det(T)').

**2.1 Definition** A  $n \times n$  *determinant* is a function  $\det: \mathcal{M}_{n \times n} \rightarrow \mathbb{R}$  such that

- (1)  $\det(\vec{\rho}_1, \dots, k \cdot \vec{\rho}_i + \vec{\rho}_j, \dots, \vec{\rho}_n) = \det(\vec{\rho}_1, \dots, \vec{\rho}_j, \dots, \vec{\rho}_n)$  for  $i \neq j$
- (2)  $\det(\vec{\rho}_1, \dots, \vec{\rho}_j, \dots, \vec{\rho}_i, \dots, \vec{\rho}_n) = -\det(\vec{\rho}_1, \dots, \vec{\rho}_i, \dots, \vec{\rho}_j, \dots, \vec{\rho}_n)$  for  $i \neq j$
- (3)  $\det(\vec{\rho}_1, \dots, k\vec{\rho}_i, \dots, \vec{\rho}_n) = k \cdot \det(\vec{\rho}_1, \dots, \vec{\rho}_i, \dots, \vec{\rho}_n)$  for any scalar  $k$
- (4)  $\det(I) = 1$  where  $I$  is an identity matrix

(the  $\vec{\rho}$ 's are the rows of the matrix). We often write  $|T|$  for  $\det(T)$ .

**2.2 Remark** Property (2) is redundant since

$$T \xrightarrow{\rho_i + \rho_j} \xrightarrow{-\rho_j + \rho_i} \xrightarrow{\rho_i + \rho_j} \xrightarrow{-\rho_i} \hat{T}$$

swaps rows  $i$  and  $j$ . We have listed it only for convenience.

**2.3 Remark** In Gauss' method the operation of multiplying a row by a constant  $k$  had a restriction that  $k \neq 0$ . Property (3) does not have the restriction because the next result shows that we do not need it here.

**2.4 Lemma** A matrix with two identical rows has a determinant of zero. A matrix with a zero row has a determinant of zero. A matrix is nonsingular if and only if its determinant is nonzero. The determinant of an echelon form matrix is the product down its diagonal.

**PROOF** To verify the first sentence, swap the two equal rows. The sign of the determinant changes but the matrix is the same and so its determinant is the same. Thus the determinant is zero.

The second sentence follows from property (3). Multiply the zero row by two. That doubles the determinant but it also leaves the row unchanged and hence leaves the determinant unchanged. Thus the determinant must be zero.

For the third sentence, where  $T \rightarrow \cdots \rightarrow \hat{T}$  is the Gauss-Jordan reduction, by the definition the determinant of  $T$  is zero if and only if the determinant of  $\hat{T}$  is zero (although the two could differ in sign or magnitude). A nonsingular  $T$  Gauss-Jordan reduces to an identity matrix and so has a nonzero determinant. A singular  $T$  reduces to a  $\hat{T}$  with a zero row; by the second sentence of this lemma its determinant is zero.

The fourth sentence has two cases. If the echelon form matrix is singular then it has a zero row. Thus it has a zero on its diagonal, so the product down its diagonal is zero. By the third sentence the determinant is zero and therefore this matrix's determinant equals the product down its diagonal.

If the echelon form matrix is nonsingular then none of its diagonal entries is zero so we can use property (3) to get 1's on the diagonal (again, the vertical bars  $|\cdots|$  indicate the determinant operation).

$$\begin{vmatrix} t_{1,1} & t_{1,2} & & t_{1,n} \\ 0 & t_{2,2} & & t_{2,n} \\ & & \ddots & \\ 0 & & & t_{n,n} \end{vmatrix} = t_{1,1} \cdot t_{2,2} \cdots t_{n,n} \cdot \begin{vmatrix} 1 & t_{1,2}/t_{1,1} & & t_{1,n}/t_{1,1} \\ 0 & 1 & & t_{2,n}/t_{2,2} \\ & & \ddots & \\ 0 & & & 1 \end{vmatrix}$$

Then the Jordan half of Gauss-Jordan elimination, using property (1) of the definition, leaves the identity matrix.

$$= t_{1,1} \cdot t_{2,2} \cdots t_{n,n} \cdot \begin{vmatrix} 1 & 0 & & 0 \\ 0 & 1 & & 0 \\ & & \ddots & \\ 0 & & & 1 \end{vmatrix} = t_{1,1} \cdot t_{2,2} \cdots t_{n,n} \cdot 1$$

So in this case also, the determinant is the product down the diagonal. QED

That gives us a way to compute the value of a determinant function on a matrix: do Gaussian reduction, keeping track of any changes of sign caused by row swaps and any scalars that we factor out, and finish by multiplying down the diagonal of the echelon form result. This algorithm is just as fast as Gauss' method and so practical on all of the matrices that we will see.

**2.5 Example** Doing  $2 \times 2$  determinants with Gauss' method

$$\begin{vmatrix} 2 & 4 \\ -1 & 3 \end{vmatrix} = \begin{vmatrix} 2 & 4 \\ 0 & 5 \end{vmatrix} = 10$$

doesn't give a big time savings because the  $2 \times 2$  determinant formula is easy. However, a  $3 \times 3$  determinant is often easier to calculate with Gauss' method

than with the formula given earlier.

$$\begin{vmatrix} 2 & 2 & 6 \\ 4 & 4 & 3 \\ 0 & -3 & 5 \end{vmatrix} = \begin{vmatrix} 2 & 2 & 6 \\ 0 & 0 & -9 \\ 0 & -3 & 5 \end{vmatrix} = - \begin{vmatrix} 2 & 2 & 6 \\ 0 & -3 & 5 \\ 0 & 0 & -9 \end{vmatrix} = -54$$

**2.6 Example** Determinants bigger than  $3 \times 3$  go quickly with the Gauss' method procedure.

$$\begin{vmatrix} 1 & 0 & 1 & 3 \\ 0 & 1 & 1 & 4 \\ 0 & 0 & 0 & 5 \\ 0 & 1 & 0 & 1 \end{vmatrix} = \begin{vmatrix} 1 & 0 & 1 & 3 \\ 0 & 1 & 1 & 4 \\ 0 & 0 & 0 & 5 \\ 0 & 0 & -1 & -3 \end{vmatrix} = - \begin{vmatrix} 1 & 0 & 1 & 3 \\ 0 & 1 & 1 & 4 \\ 0 & 0 & -1 & -3 \\ 0 & 0 & 0 & 5 \end{vmatrix} = -(-5) = 5$$

The prior example illustrates an important point. Although we have not yet found a  $4 \times 4$  determinant formula, if one exists then we know what value it gives to the matrix — if there is a function with properties (1)-(4) then on the above matrix the function must return 5.

**2.7 Lemma** For each  $n$ , if there is an  $n \times n$  determinant function then it is unique.

**PROOF** For any  $n \times n$  matrix we can perform Gauss' method on the matrix, keeping track of how the sign alternates on row swaps, and then multiply down the diagonal of the echelon form result. By the definition and the lemma, all  $n \times n$  determinant functions must return the same value on the matrix. QED

The 'if there is an  $n \times n$  determinant function' emphasizes that although we can use Gauss' method to compute the only value that a determinant function could possibly return, we haven't yet shown that such a function exists for all  $n$ . In the rest of the section we will do that.

### Exercises

For these, assume that an  $n \times n$  determinant function exists for all  $n$ .

✓ **2.8** Use Gauss' method to find each determinant.

$$(a) \begin{vmatrix} 3 & 1 & 2 \\ 3 & 1 & 0 \\ 0 & 1 & 4 \end{vmatrix} \quad (b) \begin{vmatrix} 1 & 0 & 0 & 1 \\ 2 & 1 & 1 & 0 \\ -1 & 0 & 1 & 0 \\ 1 & 1 & 1 & 0 \end{vmatrix}$$

**2.9** Use Gauss' method to find each.

$$(a) \begin{vmatrix} 2 & -1 \\ -1 & -1 \end{vmatrix} \quad (b) \begin{vmatrix} 1 & 1 & 0 \\ 3 & 0 & 2 \\ 5 & 2 & 2 \end{vmatrix}$$

**2.10** For which values of  $k$  does this system have a unique solution?

$$\begin{aligned} x + z - w &= 2 \\ y - 2z &= 3 \\ x + kz &= 4 \\ z - w &= 2 \end{aligned}$$

✓ **2.11** Express each of these in terms of  $|H|$ .

$$(a) \begin{vmatrix} h_{3,1} & h_{3,2} & h_{3,3} \\ h_{2,1} & h_{2,2} & h_{2,3} \\ h_{1,1} & h_{1,2} & h_{1,3} \end{vmatrix}$$

$$(b) \begin{vmatrix} -h_{1,1} & -h_{1,2} & -h_{1,3} \\ -2h_{2,1} & -2h_{2,2} & -2h_{2,3} \\ -3h_{3,1} & -3h_{3,2} & -3h_{3,3} \end{vmatrix}$$

$$(c) \begin{vmatrix} h_{1,1} + h_{3,1} & h_{1,2} + h_{3,2} & h_{1,3} + h_{3,3} \\ h_{2,1} & h_{2,2} & h_{2,3} \\ 5h_{3,1} & 5h_{3,2} & 5h_{3,3} \end{vmatrix}$$

- ✓ 2.12 Find the determinant of a diagonal matrix.
- 2.13 Describe the solution set of a homogeneous linear system if the determinant of the matrix of coefficients is nonzero.
- ✓ 2.14 Show that this determinant is zero.

$$\begin{vmatrix} y+z & x+z & x+y \\ x & y & z \\ 1 & 1 & 1 \end{vmatrix}$$

- 2.15 (a) Find the  $1 \times 1$ ,  $2 \times 2$ , and  $3 \times 3$  matrices with  $i, j$  entry given by  $(-1)^{i+j}$ .  
 (b) Find the determinant of the square matrix with  $i, j$  entry  $(-1)^{i+j}$ .
- 2.16 (a) Find the  $1 \times 1$ ,  $2 \times 2$ , and  $3 \times 3$  matrices with  $i, j$  entry given by  $i + j$ .  
 (b) Find the determinant of the square matrix with  $i, j$  entry  $i + j$ .
- ✓ 2.17 Show that determinant functions are not linear by giving a case where  $|A + B| \neq |A| + |B|$ .
- 2.18 The second condition in the definition, that row swaps change the sign of a determinant, is somewhat annoying. It means we have to keep track of the number of swaps, to compute how the sign alternates. Can we get rid of it? Can we replace it with the condition that row swaps leave the determinant unchanged? (If so then we would need new  $1 \times 1$ ,  $2 \times 2$ , and  $3 \times 3$  formulas, but that would be a minor matter.)
- 2.19 Prove that the determinant of any triangular matrix, upper or lower, is the product down its diagonal.
- 2.20 Refer to the definition of elementary matrices in the Mechanics of Matrix Multiplication subsection.
- (a) What is the determinant of each kind of elementary matrix?  
 (b) Prove that if  $E$  is any elementary matrix then  $|ES| = |E||S|$  for any appropriately sized  $S$ .  
 (c) (*This question doesn't involve determinants.*) Prove that if  $T$  is singular then a product  $TS$  is also singular.  
 (d) Show that  $|TS| = |T||S|$ .  
 (e) Show that if  $T$  is nonsingular then  $|T^{-1}| = |T|^{-1}$ .
- 2.21 Prove that the determinant of a product is the product of the determinants  $|TS| = |T||S|$  in this way. Fix the  $n \times n$  matrix  $S$  and consider the function  $d: \mathcal{M}_{n \times n} \rightarrow \mathbb{R}$  given by  $T \mapsto |TS|/|S|$ .
- (a) Check that  $d$  satisfies property (1) in the definition of a determinant function.  
 (b) Check property (2).  
 (c) Check property (3).  
 (d) Check property (4).  
 (e) Conclude the determinant of a product is the product of the determinants.
- 2.22 A *submatrix* of a given matrix  $A$  is one that we get by deleting some of the rows and columns of  $A$ . Thus, the first matrix here is a submatrix of the second.

$$\begin{pmatrix} 3 & 1 \\ 2 & 5 \end{pmatrix} \quad \begin{pmatrix} 3 & 4 & 1 \\ 0 & 9 & -2 \\ 2 & -1 & 5 \end{pmatrix}$$

Prove that for any square matrix, the rank of the matrix is  $r$  if and only if  $r$  is the largest integer such that there is an  $r \times r$  submatrix with a nonzero determinant.

✓ 2.23 Prove that a matrix with rational entries has a rational determinant.

? 2.24 [Am. Math. Mon., Feb. 1953] Find the element of likeness in (a) simplifying a fraction, (b) powdering the nose, (c) building new steps on the church, (d) keeping emeritus professors on campus, (e) putting B, C, D in the determinant

$$\begin{vmatrix} 1 & a & a^2 & a^3 \\ a^3 & 1 & a & a^2 \\ B & a^3 & 1 & a \\ C & D & a^3 & 1 \end{vmatrix}.$$

### I.3 The Permutation Expansion

The prior subsection defines a function to be a determinant if it satisfies four conditions, and shows that there is at most one  $n \times n$  determinant function for each  $n$ . What is left is to show that for each  $n$  such a function exists.

How could such a function not exist? After all, we have no difficulty computing determinants. We just start with a square matrix, use Gauss' method, and end by multiplying down the diagonal to get a number.

The difficulty is that we must show that the computation gives a well-defined result. Consider these two Gauss' method reductions of the same matrix, the first without any row swap

$$\begin{pmatrix} 1 & 2 \\ 3 & 4 \end{pmatrix} \xrightarrow{-3\rho_1 + \rho_2} \begin{pmatrix} 1 & 2 \\ 0 & -2 \end{pmatrix}$$

and the second with one.

$$\begin{pmatrix} 1 & 2 \\ 3 & 4 \end{pmatrix} \xrightarrow{\rho_1 \leftrightarrow \rho_2} \begin{pmatrix} 3 & 4 \\ 1 & 2 \end{pmatrix} \xrightarrow{-(1/3)\rho_1 + \rho_2} \begin{pmatrix} 3 & 4 \\ 0 & 2/3 \end{pmatrix}$$

Both calculations yield the determinant  $-2$  since in the second one we must keep track of the fact that the row swap changes the sign of the result of multiplying down the diagonal. To illustrate how a computation that is like the ones that we are doing could fail to be well-defined, suppose that Definition 2.1 did not include condition (2). That is, suppose that we instead tried to define determinants so that the value would not change on a row swap. Then first reduction above would yield  $-2$  while the second would yield  $+2$ . We could still do computations but they wouldn't give consistent outcomes—there is no function that satisfies conditions (1), (3), (4), and also this altered second condition.

Of course, observing that Definition 2.1 does the right thing with these two reductions of a single matrix is not enough. In the rest of this section we will show that there is never a conflict.

To do this we will define an alternative way to compute the value of a determinant, one that makes it easier to prove that the conditions are satisfied.

The key idea is in property (3) of Definition 2.1. It shows that the determinant function is not linear.

**3.1 Example** For this matrix

$$A = \begin{pmatrix} 2 & 1 \\ -1 & 3 \end{pmatrix}$$

$\det(2A) \neq 2 \cdot \det(A)$ . Instead, scalars come out of each of the rows separately.

$$\begin{vmatrix} 4 & 2 \\ -2 & 6 \end{vmatrix} = 2 \cdot \begin{vmatrix} 2 & 1 \\ -2 & 6 \end{vmatrix} = 4 \cdot \begin{vmatrix} 2 & 1 \\ -1 & 3 \end{vmatrix}$$

Since scalars come out a row at a time, we might guess that determinants are linear a row at a time.

**3.2 Definition** Let  $V$  be a vector space. A map  $f: V^n \rightarrow \mathbb{R}$  is *multilinear* if

$$(1) f(\vec{\rho}_1, \dots, \vec{v} + \vec{w}, \dots, \vec{\rho}_n) = f(\vec{\rho}_1, \dots, \vec{v}, \dots, \vec{\rho}_n) + f(\vec{\rho}_1, \dots, \vec{w}, \dots, \vec{\rho}_n)$$

$$(2) f(\vec{\rho}_1, \dots, k\vec{v}, \dots, \vec{\rho}_n) = k \cdot f(\vec{\rho}_1, \dots, \vec{v}, \dots, \vec{\rho}_n)$$

for  $\vec{v}, \vec{w} \in V$  and  $k \in \mathbb{R}$ .

**3.3 Lemma** Determinants are multilinear.

**PROOF** Property (2) here is just condition (3) in Definition 2.1 so we need only verify property (1).

There are two cases. If the set of other rows  $\{\vec{\rho}_1, \dots, \vec{\rho}_{i-1}, \vec{\rho}_{i+1}, \dots, \vec{\rho}_n\}$  is linearly dependent then all three matrices are singular and so all three determinants are zero and the equality is trivial.

Therefore assume that the set of other rows is linearly independent. This set has  $n - 1$  members so we can make a basis by adding one more vector  $\langle \vec{\rho}_1, \dots, \vec{\rho}_{i-1}, \vec{\beta}, \vec{\rho}_{i+1}, \dots, \vec{\rho}_n \rangle$ . Express  $\vec{v}$  and  $\vec{w}$  with respect to this basis

$$\vec{v} = v_1 \vec{\rho}_1 + \dots + v_{i-1} \vec{\rho}_{i-1} + v_i \vec{\beta} + v_{i+1} \vec{\rho}_{i+1} + \dots + v_n \vec{\rho}_n$$

$$\vec{w} = w_1 \vec{\rho}_1 + \dots + w_{i-1} \vec{\rho}_{i-1} + w_i \vec{\beta} + w_{i+1} \vec{\rho}_{i+1} + \dots + w_n \vec{\rho}_n$$

and add.

$$\vec{v} + \vec{w} = (v_1 + w_1) \vec{\rho}_1 + \dots + (v_i + w_i) \vec{\beta} + \dots + (v_n + w_n) \vec{\rho}_n$$

Consider the left side of property (1) and expand  $\vec{v} + \vec{w}$ .

$$\det(\vec{\rho}_1, \dots, (v_1 + w_1) \vec{\rho}_1 + \dots + (v_i + w_i) \vec{\beta} + \dots + (v_n + w_n) \vec{\rho}_n, \dots, \vec{\rho}_n) \quad (*)$$

By the definition of determinant's condition (1), the value of (\*) is unchanged by the operation of adding  $-(v_1 + w_1) \vec{\rho}_1$  to the  $i$ -th row  $\vec{v} + \vec{w}$ . The  $i$ -th row becomes this.

$$\vec{v} + \vec{w} - (v_1 + w_1) \vec{\rho}_1 = (v_2 + w_2) \vec{\rho}_2 + \dots + (v_i + w_i) \vec{\beta} + \dots + (v_n + w_n) \vec{\rho}_n$$

Next add  $-(v_2 + w_2)\vec{\rho}_2$ , etc., to eliminate all of the terms from the other rows. Apply the definition of determinant's condition (3).

$$\begin{aligned} \det(\vec{\rho}_1, \dots, \vec{v} + \vec{w}, \dots, \vec{\rho}_n) &= \det(\vec{\rho}_1, \dots, (v_i + w_i) \cdot \vec{\beta}, \dots, \vec{\rho}_n) \\ &= (v_i + w_i) \cdot \det(\vec{\rho}_1, \dots, \vec{\beta}, \dots, \vec{\rho}_n) \\ &= v_i \cdot \det(\vec{\rho}_1, \dots, \vec{\beta}, \dots, \vec{\rho}_n) + w_i \cdot \det(\vec{\rho}_1, \dots, \vec{\beta}, \dots, \vec{\rho}_n) \end{aligned}$$

Now this is a sum of two determinants. To finish, bring  $v_i$  and  $w_i$  back inside in front of the  $\vec{\beta}$ 's and use row combinations again, this time to reconstruct the expressions of  $\vec{v}$  and  $\vec{w}$  in terms of the basis. That is, start with the operations of adding  $v_i\vec{\rho}_1$  to  $v_i\vec{\beta}$  and  $w_i\vec{\rho}_1$  to  $w_i\vec{\beta}$ , etc., to get the expansions of  $\vec{v}$  and  $\vec{w}$ . QED

Multilinearity allows us to expand a determinant into a sum of determinants, each of which involves a simple matrix.

**3.4 Example** Use property (1) of multilinearity to break up the first row

$$\begin{vmatrix} 2 & 1 \\ 4 & 3 \end{vmatrix} = \begin{vmatrix} 2 & 0 \\ 4 & 3 \end{vmatrix} + \begin{vmatrix} 0 & 1 \\ 4 & 3 \end{vmatrix}$$

and then break each of those two along the second row.

$$= \begin{vmatrix} 2 & 0 \\ 4 & 0 \end{vmatrix} + \begin{vmatrix} 2 & 0 \\ 0 & 3 \end{vmatrix} + \begin{vmatrix} 0 & 1 \\ 4 & 0 \end{vmatrix} + \begin{vmatrix} 0 & 1 \\ 0 & 3 \end{vmatrix}$$

We are left with four determinants such that in each row of each of the four there is a single entry from the original matrix.

**3.5 Example** In the same way, a  $3 \times 3$  determinant separates into a sum of many simpler determinants. Splitting along the first row produces three determinants (we have highlighted the zero in the 1,3 position to set it off visually from the zeroes that appear as part of the splitting).

$$\begin{vmatrix} 2 & 1 & -1 \\ 4 & 3 & \mathbf{0} \\ 2 & 1 & 5 \end{vmatrix} = \begin{vmatrix} 2 & 0 & 0 \\ 4 & 3 & \mathbf{0} \\ 2 & 1 & 5 \end{vmatrix} + \begin{vmatrix} 0 & 1 & 0 \\ 4 & 3 & \mathbf{0} \\ 2 & 1 & 5 \end{vmatrix} + \begin{vmatrix} 0 & 0 & -1 \\ 4 & 3 & \mathbf{0} \\ 2 & 1 & 5 \end{vmatrix}$$

Each of these splits in three along the second row. Each of the nine splits in three along the third row, resulting in twenty seven determinants such that each row contains a single entry from the starting matrix.

$$= \begin{vmatrix} 2 & 0 & 0 \\ 4 & 0 & 0 \\ 2 & 0 & 0 \end{vmatrix} + \begin{vmatrix} 2 & 0 & 0 \\ 4 & 0 & 0 \\ 0 & 1 & 0 \end{vmatrix} + \begin{vmatrix} 2 & 0 & 0 \\ 4 & 0 & 0 \\ 0 & 0 & 5 \end{vmatrix} + \begin{vmatrix} 2 & 0 & 0 \\ 0 & 3 & 0 \\ 2 & 0 & 0 \end{vmatrix} + \dots + \begin{vmatrix} 0 & 0 & -1 \\ 0 & 0 & \mathbf{0} \\ 0 & 0 & 5 \end{vmatrix}$$

So with multilinearity, an  $n \times n$  determinant expands into a sum of  $n^n$  determinants where each row of each summand contains a single entry from the starting matrix. However, many of these summand determinants are zero.

**3.6 Example** In each of these examples from the prior expansion, two of the entries from the original matrix are in the same column.

$$\begin{vmatrix} 2 & 0 & 0 \\ 4 & 0 & 0 \\ 0 & 1 & 0 \end{vmatrix} \quad \begin{vmatrix} 0 & 0 & -1 \\ 0 & 3 & 0 \\ 0 & 0 & 5 \end{vmatrix} \quad \begin{vmatrix} 0 & 1 & 0 \\ 0 & 0 & 0 \\ 0 & 0 & 5 \end{vmatrix}$$

For instance in the first matrix, the 2 and the 4 both come from the first column of the original matrix. Any such matrix is singular because one row is a multiple of the other. Thus, any such determinant is zero, by Lemma 2.4.

With that observation the above expansion of the  $3 \times 3$  determinant into the sum of the twenty seven determinants simplifies to the sum of these six, the ones where the entries from the original matrix come not just one per row but also one per column.

$$\begin{vmatrix} 2 & 1 & -1 \\ 4 & 3 & 0 \\ 2 & 1 & 5 \end{vmatrix} = \begin{vmatrix} 2 & 0 & 0 \\ 0 & 3 & 0 \\ 0 & 0 & 5 \end{vmatrix} + \begin{vmatrix} 2 & 0 & 0 \\ 0 & 0 & 0 \\ 0 & 1 & 0 \end{vmatrix} \\ + \begin{vmatrix} 0 & 1 & 0 \\ 4 & 0 & 0 \\ 0 & 0 & 5 \end{vmatrix} + \begin{vmatrix} 0 & 1 & 0 \\ 0 & 0 & 0 \\ 2 & 0 & 0 \end{vmatrix} \\ + \begin{vmatrix} 0 & 0 & -1 \\ 4 & 0 & 0 \\ 0 & 1 & 0 \end{vmatrix} + \begin{vmatrix} 0 & 0 & -1 \\ 0 & 3 & 0 \\ 2 & 0 & 0 \end{vmatrix}$$

We can bring out the scalars.

$$= (2)(3)(5) \begin{vmatrix} 1 & 0 & 0 \\ 0 & 1 & 0 \\ 0 & 0 & 1 \end{vmatrix} + (2)(0)(1) \begin{vmatrix} 1 & 0 & 0 \\ 0 & 0 & 1 \\ 0 & 1 & 0 \end{vmatrix} \\ + (1)(4)(5) \begin{vmatrix} 0 & 1 & 0 \\ 1 & 0 & 0 \\ 0 & 0 & 1 \end{vmatrix} + (1)(0)(2) \begin{vmatrix} 0 & 1 & 0 \\ 0 & 0 & 1 \\ 1 & 0 & 0 \end{vmatrix} \\ + (-1)(4)(1) \begin{vmatrix} 0 & 0 & 1 \\ 1 & 0 & 0 \\ 0 & 1 & 0 \end{vmatrix} + (-1)(3)(2) \begin{vmatrix} 0 & 0 & 1 \\ 0 & 1 & 0 \\ 1 & 0 & 0 \end{vmatrix}$$

To finish, we evaluate those six determinants by row-swapping them to the identity matrix, keeping track of the sign changes.

$$= 30 \cdot (+1) + 0 \cdot (-1) \\ + 20 \cdot (-1) + 0 \cdot (+1) \\ - 4 \cdot (+1) - 6 \cdot (-1) = 12$$

That example captures the new calculation scheme. Multilinearity gives us many separate determinants, each with one entry per row from the original



matrix. Most of these have one row that is a multiple of another so we can omit them. We are left with those determinants that have one entry per row and column from the original matrix. By factoring out the scalars we can further reduce the determinants that we must compute to those one-entry-per-row-and-column matrices where all the entries are 1's.

**3.7 Definition** A square matrix whose entries are 0 except for one 1 in each row and column is a *permutation matrix*.

We next introduce a notation for permutation matrices. Let  $\iota_j$  be the row vector that is all 0's except for a 1 in its  $j$ -th entry, so that the four-wide  $\iota_2$  is  $\begin{pmatrix} 0 & 1 & 0 & 0 \end{pmatrix}$ . We can construct permutation matrices by permuting, that is, scrambling, the numbers 1, 2, ...,  $n$ , and using them as indices on the  $\iota$ 's. For instance, to get a  $4 \times 4$  permutation matrix, we can scramble the numbers from 1 to 4 into this sequence  $\langle 3, 2, 1, 4 \rangle$  and take the corresponding  $\iota$ 's.

$$\begin{pmatrix} \iota_3 \\ \iota_2 \\ \iota_1 \\ \iota_4 \end{pmatrix} = \begin{pmatrix} 0 & 0 & 1 & 0 \\ 0 & 1 & 0 & 0 \\ 1 & 0 & 0 & 0 \\ 0 & 0 & 0 & 1 \end{pmatrix}$$

**3.8 Definition** An  $n$ -*permutation* is an arrangement of the numbers 1, ...,  $n$ .

**3.9 Example** The 2-permutations are  $\phi_1 = \langle 1, 2 \rangle$  and  $\phi_2 = \langle 2, 1 \rangle$ . These are the associated permutation matrices.

$$P_{\phi_1} = \begin{pmatrix} \iota_1 \\ \iota_2 \end{pmatrix} = \begin{pmatrix} 1 & 0 \\ 0 & 1 \end{pmatrix} \quad P_{\phi_2} = \begin{pmatrix} \iota_2 \\ \iota_1 \end{pmatrix} = \begin{pmatrix} 0 & 1 \\ 1 & 0 \end{pmatrix}$$

We sometimes write permutations as functions, e.g.,  $\phi_2(1) = 2$ , and  $\phi_2(2) = 1$ . Then  $P_{\phi_2}$ 's first row is  $\iota_{\phi_2(1)} = \iota_2$  and its second is  $\iota_{\phi_2(2)} = \iota_1$ .

The 3-permutations are  $\phi_1 = \langle 1, 2, 3 \rangle$ ,  $\phi_2 = \langle 1, 3, 2 \rangle$ ,  $\phi_3 = \langle 2, 1, 3 \rangle$ ,  $\phi_4 = \langle 2, 3, 1 \rangle$ ,  $\phi_5 = \langle 3, 1, 2 \rangle$ , and  $\phi_6 = \langle 3, 2, 1 \rangle$ . One example permutation matrix is  $P_{\phi_5}$  with rows  $\iota_{\phi_5(1)} = \iota_3$ ,  $\iota_{\phi_5(2)} = \iota_1$ , and  $\iota_{\phi_5(3)} = \iota_2$ .

$$P_{\phi_5} = \begin{pmatrix} \iota_3 \\ \iota_1 \\ \iota_2 \end{pmatrix} = \begin{pmatrix} 0 & 0 & 1 \\ 1 & 0 & 0 \\ 0 & 1 & 0 \end{pmatrix}$$

**3.10 Definition** The *permutation expansion* for determinants is

$$\begin{vmatrix} t_{1,1} & t_{1,2} & \dots & t_{1,n} \\ t_{2,1} & t_{2,2} & \dots & t_{2,n} \\ \vdots & \vdots & \ddots & \vdots \\ t_{n,1} & t_{n,2} & \dots & t_{n,n} \end{vmatrix} = t_{1,\phi_1(1)}t_{2,\phi_1(2)} \cdots t_{n,\phi_1(n)}|P_{\phi_1}| \\ + t_{1,\phi_2(1)}t_{2,\phi_2(2)} \cdots t_{n,\phi_2(n)}|P_{\phi_2}| \\ \vdots \\ + t_{1,\phi_k(1)}t_{2,\phi_k(2)} \cdots t_{n,\phi_k(n)}|P_{\phi_k}|$$

where  $\phi_1, \dots, \phi_k$  are all of the  $n$ -permutations.

This formula is often written in *summation notation*

$$|T| = \sum_{\text{permutations } \phi} t_{1,\phi(1)} t_{2,\phi(2)} \cdots t_{n,\phi(n)} |P_\phi|$$

read aloud as, “the sum, over all permutations  $\phi$ , of terms having the form  $t_{1,\phi(1)} t_{2,\phi(2)} \cdots t_{n,\phi(n)} |P_\phi|$ .”

**3.11 Example** The familiar  $2 \times 2$  determinant formula follows from the above.

$$\begin{aligned} \begin{vmatrix} t_{1,1} & t_{1,2} \\ t_{2,1} & t_{2,2} \end{vmatrix} &= t_{1,1} t_{2,2} \cdot |P_{\phi_1}| + t_{1,2} t_{2,1} \cdot |P_{\phi_2}| \\ &= t_{1,1} t_{2,2} \cdot \begin{vmatrix} 1 & 0 \\ 0 & 1 \end{vmatrix} + t_{1,2} t_{2,1} \cdot \begin{vmatrix} 0 & 1 \\ 1 & 0 \end{vmatrix} \\ &= t_{1,1} t_{2,2} - t_{1,2} t_{2,1} \end{aligned}$$

So does the  $3 \times 3$  determinant formula.

$$\begin{aligned} \begin{vmatrix} t_{1,1} & t_{1,2} & t_{1,3} \\ t_{2,1} & t_{2,2} & t_{2,3} \\ t_{3,1} & t_{3,2} & t_{3,3} \end{vmatrix} &= t_{1,1} t_{2,2} t_{3,3} |P_{\phi_1}| + t_{1,1} t_{2,3} t_{3,2} |P_{\phi_2}| + t_{1,2} t_{2,1} t_{3,3} |P_{\phi_3}| \\ &\quad + t_{1,2} t_{2,3} t_{3,1} |P_{\phi_4}| + t_{1,3} t_{2,1} t_{3,2} |P_{\phi_5}| + t_{1,3} t_{2,2} t_{3,1} |P_{\phi_6}| \\ &= t_{1,1} t_{2,2} t_{3,3} - t_{1,1} t_{2,3} t_{3,2} - t_{1,2} t_{2,1} t_{3,3} \\ &\quad + t_{1,2} t_{2,3} t_{3,1} + t_{1,3} t_{2,1} t_{3,2} - t_{1,3} t_{2,2} t_{3,1} \end{aligned}$$

Computing a determinant by permutation expansion usually takes longer than Gauss' method. However, while it is not often used in practice, we use it for the theory, to prove that the determinant function is well-defined.

We will just state the result here and defer its proof to the following subsection.

**3.12 Theorem** For each  $n$  there is an  $n \times n$  determinant function.

Also in the next subsection is the proof of this result (these two proofs share some features).

**3.13 Theorem** The determinant of a matrix equals the determinant of its transpose.

Because of this theorem, while we have so far stated determinant results in terms of rows (e.g., determinants are multilinear in their rows, row swaps change the sign, etc.), all of the results also hold in terms of columns.

**3.14 Corollary** A matrix with two equal columns is singular. Column swaps change the sign of a determinant. Determinants are multilinear in their columns.

**PROOF** For the first statement, transposing the matrix results in a matrix with the same determinant, and with two equal rows, and hence a determinant of zero. We can prove the other two in the same way. QED

We finish this subsection with a summary: determinant functions exist, are unique, and we know how to compute them. As for what determinants are about, perhaps these lines [Kemp] help make it memorable.

Determinant none,  
 Solution: lots or none.  
 Determinant some,  
 Solution: just one.

### Exercises

*This summarizes the notation that we use for the 2- and 3- permutations.*

i	1	2		i	1	2	3
$\phi_1(i)$	1	2		$\phi_1(i)$	1	2	3
$\phi_2(i)$	2	1		$\phi_2(i)$	1	3	2
				$\phi_3(i)$	2	1	3
				$\phi_4(i)$	2	3	1
				$\phi_5(i)$	3	1	2
				$\phi_6(i)$	3	2	1

✓ 3.15 Compute the determinant by using the permutation expansion.

$$(a) \begin{vmatrix} 1 & 2 & 3 \\ 4 & 5 & 6 \\ 7 & 8 & 9 \end{vmatrix} \quad (b) \begin{vmatrix} 2 & 2 & 1 \\ 3 & -1 & 0 \\ -2 & 0 & 5 \end{vmatrix}$$

✓ 3.16 Compute these both with Gauss' method and the permutation expansion formula.

$$(a) \begin{vmatrix} 2 & 1 \\ 3 & 1 \end{vmatrix} \quad (b) \begin{vmatrix} 0 & 1 & 4 \\ 0 & 2 & 3 \\ 1 & 5 & 1 \end{vmatrix}$$

✓ 3.17 Use the permutation expansion formula to derive the formula for  $3 \times 3$  determinants.

3.18 List all of the 4-permutations.

3.19 A permutation, regarded as a function from the set  $\{1, \dots, n\}$  to itself, is one-to-one and onto. Therefore, each permutation has an inverse.

- (a) Find the inverse of each 2-permutation.  
 (b) Find the inverse of each 3-permutation.

3.20 Prove that  $f$  is multilinear if and only if for all  $\vec{v}, \vec{w} \in V$  and  $k_1, k_2 \in \mathbb{R}$ , this holds.

$$f(\vec{\rho}_1, \dots, k_1 \vec{v}_1 + k_2 \vec{v}_2, \dots, \vec{\rho}_n) = k_1 f(\vec{\rho}_1, \dots, \vec{v}_1, \dots, \vec{\rho}_n) + k_2 f(\vec{\rho}_1, \dots, \vec{v}_2, \dots, \vec{\rho}_n)$$

3.21 How would determinants change if we changed property (4) of the definition to read that  $|I| = 2$ ?

3.22 Verify the second and third statements in Corollary 3.14.

✓ 3.23 Show that if an  $n \times n$  matrix has a nonzero determinant then we can express any column vector  $\vec{v} \in \mathbb{R}^n$  as a linear combination of the columns of the matrix.

3.24 [Strang 80] True or false: a matrix whose entries are only zeros or ones has a determinant equal to zero, one, or negative one.

3.25 (a) Show that there are 120 terms in the permutation expansion formula of a  $5 \times 5$  matrix.

(b) How many are sure to be zero if the 1, 2 entry is zero?

3.26 How many  $n$ -permutations are there?

3.27 Show that the inverse of a permutation matrix is its transpose.

3.28 A matrix  $A$  is *skew-symmetric* if  $A^{\text{trans}} = -A$ , as in this matrix.

$$A = \begin{pmatrix} 0 & 3 \\ -3 & 0 \end{pmatrix}$$

Show that  $n \times n$  skew-symmetric matrices with nonzero determinants exist only for even  $n$ .

✓ 3.29 What is the smallest number of zeros, and the placement of those zeros, needed to ensure that a  $4 \times 4$  matrix has a determinant of zero?

✓ 3.30 If we have  $n$  data points  $(x_1, y_1), (x_2, y_2), \dots, (x_n, y_n)$  and want to find a polynomial  $p(x) = a_{n-1}x^{n-1} + a_{n-2}x^{n-2} + \dots + a_1x + a_0$  passing through those points then we can plug in the points to get an  $n$  equation/ $n$  unknown linear system. The matrix of coefficients for that system is the *Vandermonde matrix*. Prove that the determinant of the transpose of that matrix of coefficients

$$\begin{vmatrix} 1 & 1 & \dots & 1 \\ x_1 & x_2 & \dots & x_n \\ x_1^2 & x_2^2 & \dots & x_n^2 \\ \vdots & \vdots & \dots & \vdots \\ x_1^{n-1} & x_2^{n-1} & \dots & x_n^{n-1} \end{vmatrix}$$

equals the product, over all indices  $i, j \in \{1, \dots, n\}$  with  $i < j$ , of terms of the form  $x_j - x_i$ . (This shows that the determinant is zero, and the linear system has no solution, if and only if the  $x_i$ 's in the data are not distinct.)

3.31 We can divide a matrix into *blocks*, as here,

$$\left( \begin{array}{cc|c} 1 & 2 & 0 \\ 3 & 4 & 0 \\ \hline 0 & 0 & -2 \end{array} \right)$$

which shows four blocks, the square  $2 \times 2$  and  $1 \times 1$  ones in the upper left and lower right, and the zero blocks in the upper right and lower left. Show that if a matrix is such that we can partition it as

$$T = \left( \begin{array}{c|c} J & Z_2 \\ \hline Z_1 & K \end{array} \right)$$

where  $J$  and  $K$  are square, and  $Z_1$  and  $Z_2$  are all zeroes, then  $|T| = |J| \cdot |K|$ .

✓ 3.32 Prove that for any  $n \times n$  matrix  $T$  there are at most  $n$  distinct reals  $r$  such that the matrix  $T - rI$  has determinant zero (we shall use this result in Chapter Five).

? 3.33 [Math. Mag., Jan. 1963, Q307] The nine positive digits can be arranged into  $3 \times 3$  arrays in  $9!$  ways. Find the sum of the determinants of these arrays.

3.34 [Math. Mag., Jan. 1963, Q237] Show that

$$\begin{vmatrix} x-2 & x-3 & x-4 \\ x+1 & x-1 & x-3 \\ x-4 & x-7 & x-10 \end{vmatrix} = 0.$$

? 3.35 [Am. Math. Mon., Jan. 1949] Let  $S$  be the sum of the integer elements of a magic square of order three and let  $D$  be the value of the square considered as a determinant. Show that  $D/S$  is an integer.

? 3.36 [Am. Math. Mon., Jun. 1931] Show that the determinant of the  $n^2$  elements in

the upper left corner of the Pascal triangle

$$\begin{array}{cccccc} 1 & 1 & 1 & 1 & . & . \\ 1 & 2 & 3 & . & . & \\ 1 & 3 & . & . & & \\ 1 & . & . & & & \\ \vdots & & & & & \\ \vdots & & & & & \end{array}$$

has the value unity.

## I.4 Determinants Exist

*This subsection is optional. It proves two results from the prior subsection. These proofs involve the properties of permutations, which will use again only in the optional Jordan Canonical Form subsection.*

The prior subsection develops the permutation expansion formula for determinants.

$$\begin{aligned} \begin{vmatrix} t_{1,1} & t_{1,2} & \cdots & t_{1,n} \\ t_{2,1} & t_{2,2} & \cdots & t_{2,n} \\ \vdots & \vdots & \ddots & \vdots \\ t_{n,1} & t_{n,2} & \cdots & t_{n,n} \end{vmatrix} &= t_{1,\phi_1(1)} t_{2,\phi_1(2)} \cdots t_{n,\phi_1(n)} |P_{\phi_1}| \\ &+ t_{1,\phi_2(1)} t_{2,\phi_2(2)} \cdots t_{n,\phi_2(n)} |P_{\phi_2}| \\ &\vdots \\ &+ t_{1,\phi_k(1)} t_{2,\phi_k(2)} \cdots t_{n,\phi_k(n)} |P_{\phi_k}| \\ &= \sum_{\text{permutations } \phi} t_{1,\phi(1)} t_{2,\phi(2)} \cdots t_{n,\phi(n)} |P_{\phi}| \end{aligned}$$

This reduces the problem of showing that for any size  $n$  the determinant function on all  $n \times n$  matrices is well-defined to only showing that the determinant is well-defined on the set of permutation matrices of that size.

A permutation matrix can be row-swapped to the identity matrix and so we can calculate its determinant by keeping track of the number of swaps. However, we still must show that the result is well-defined. Recall what the difficulty is: the determinant of

$$P_{\phi} = \begin{pmatrix} 0 & 1 & 0 & 0 \\ 1 & 0 & 0 & 0 \\ 0 & 0 & 1 & 0 \\ 0 & 0 & 0 & 1 \end{pmatrix}$$

could be computed with one swap

$$P_{\phi} \xrightarrow{\rho_1 \leftrightarrow \rho_2} \begin{pmatrix} 1 & 0 & 0 & 0 \\ 0 & 1 & 0 & 0 \\ 0 & 0 & 1 & 0 \\ 0 & 0 & 0 & 1 \end{pmatrix}$$

or with three.

$$P_\phi \xrightarrow{\rho_3 \leftrightarrow \rho_1} \begin{pmatrix} 0 & 0 & 1 & 0 \\ 1 & 0 & 0 & 0 \\ 0 & 1 & 0 & 0 \\ 0 & 0 & 0 & 1 \end{pmatrix} \xrightarrow{\rho_2 \leftrightarrow \rho_3} \begin{pmatrix} 0 & 0 & 1 & 0 \\ 0 & 1 & 0 & 0 \\ 1 & 0 & 0 & 0 \\ 0 & 0 & 0 & 1 \end{pmatrix} \xrightarrow{\rho_1 \leftrightarrow \rho_3} \begin{pmatrix} 1 & 0 & 0 & 0 \\ 0 & 1 & 0 & 0 \\ 0 & 0 & 1 & 0 \\ 0 & 0 & 0 & 1 \end{pmatrix}$$

Both reductions have an odd number of swaps so we figure that  $|P_\phi| = -1$  but if there were some way to do it with an even number of swaps then we would have two different answers to one question. Below, Corollary 4.4 proves that this cannot happen—there is no permutation matrix that can be row-swapped to an identity matrix in two ways, one with an even number of swaps and the other with an odd number of swaps.

So the critical step will be a way to calculate whether the number of swaps that it takes could be even or odd.

#### 4.1 Definition Two rows of a permutation matrix

$$\begin{pmatrix} \vdots \\ \iota_k \\ \vdots \\ \iota_j \\ \vdots \end{pmatrix}$$

such that  $k > j$  are in an *inversion* of their natural order.

#### 4.2 Example This permutation matrix

$$\begin{pmatrix} \iota_3 \\ \iota_2 \\ \iota_1 \end{pmatrix} = \begin{pmatrix} 0 & 0 & 1 \\ 0 & 1 & 0 \\ 1 & 0 & 0 \end{pmatrix}$$

has three inversions:  $\iota_3$  precedes  $\iota_1$ ,  $\iota_3$  precedes  $\iota_2$ , and  $\iota_2$  precedes  $\iota_1$ .

#### 4.3 Lemma A row-swap in a permutation matrix changes the number of inversions from even to odd, or from odd to even.

**PROOF** Consider a swap of rows  $j$  and  $k$ , where  $k > j$ . If the two rows are adjacent

$$P_\phi = \begin{pmatrix} \vdots \\ \iota_{\phi(j)} \\ \iota_{\phi(k)} \\ \vdots \end{pmatrix} \xrightarrow{\rho_k \leftrightarrow \rho_j} \begin{pmatrix} \vdots \\ \iota_{\phi(k)} \\ \iota_{\phi(j)} \\ \vdots \end{pmatrix}$$

then since inversions involving rows not in this pair are not affected, the swap changes the total number of inversions by one, either removing or producing one

inversion depending on whether  $\phi(j) > \phi(k)$  or not. Consequently, the total number of inversions changes from odd to even or from even to odd.

If the rows are not adjacent then we can swap them via a sequence of adjacent swaps, first bringing row  $k$  up

$$\begin{pmatrix} \vdots \\ \iota_{\phi(j)} \\ \iota_{\phi(j+1)} \\ \iota_{\phi(j+2)} \\ \vdots \\ \iota_{\phi(k)} \\ \vdots \end{pmatrix} \xrightarrow{\rho_k \leftrightarrow \rho_{k-1}} \xrightarrow{\rho_{k-1} \leftrightarrow \rho_{k-2}} \dots \xrightarrow{\rho_{j+1} \leftrightarrow \rho_j} \begin{pmatrix} \vdots \\ \iota_{\phi(k)} \\ \iota_{\phi(j)} \\ \iota_{\phi(j+1)} \\ \vdots \\ \iota_{\phi(k-1)} \\ \vdots \end{pmatrix}$$

and then bringing row  $j$  down.

$$\xrightarrow{\rho_{j+1} \leftrightarrow \rho_{j+2}} \xrightarrow{\rho_{j+2} \leftrightarrow \rho_{j+3}} \dots \xrightarrow{\rho_{k-1} \leftrightarrow \rho_k} \begin{pmatrix} \vdots \\ \iota_{\phi(k)} \\ \iota_{\phi(j+1)} \\ \iota_{\phi(j+2)} \\ \vdots \\ \iota_{\phi(j)} \\ \vdots \end{pmatrix}$$

Each of these adjacent swaps changes the number of inversions from odd to even or from even to odd. There are an odd number  $(k - j) + (k - j - 1)$  of them. The total change in the number of inversions is from even to odd or from odd to even. QED

**4.4 Corollary** If a permutation matrix has an odd number of inversions then swapping it to the identity takes an odd number of swaps. If it has an even number of inversions then swapping to the identity takes an even number of swaps.

**PROOF** The identity matrix has zero inversions. To change an odd number to zero requires an odd number of swaps, and to change an even number to zero requires an even number of swaps. QED

**4.5 Definition** The *sgnum* of a permutation  $\text{sgn}(\phi)$  is  $-1$  if the number of inversions in  $P_\phi$  is odd and is  $+1$  if the number of inversions is even.

**4.6 Example** In the notation for the 3-permutations from Example 3.9 we have

$$P_{\phi_1} = \begin{pmatrix} 1 & 0 & 0 \\ 0 & 1 & 0 \\ 0 & 0 & 1 \end{pmatrix} \quad \text{and} \quad P_{\phi_2} = \begin{pmatrix} 1 & 0 & 0 \\ 0 & 0 & 1 \\ 0 & 1 & 0 \end{pmatrix}$$

so  $\text{sgn}(\phi_1) = 1$  because there are no inversions, while  $\text{sgn}(\phi_2) = -1$  because there is one.

We still have not shown that the determinant function is well-defined because we have not considered row operations on permutation matrices other than row swaps. We will finesse this issue. We will define a function  $d: \mathcal{M}_{n \times n} \rightarrow \mathbb{R}$  by altering the permutation expansion formula, replacing  $|P_\phi|$  with  $\text{sgn}(\phi)$ .

$$d(T) = \sum_{\text{permutations } \phi} t_{1,\phi(1)} t_{2,\phi(2)} \cdots t_{n,\phi(n)} \text{sgn}(\phi)$$

This gives the same value as the permutation expansion because the corollary shows that  $\det(P_\phi) = \text{sgn}(\phi)$ . The advantage of this formula is that the number of inversions is clearly well-defined—just count them. Therefore, we will finish showing that an  $n \times n$  determinant function exists by showing that this  $d$  satisfies the conditions in the determinant's definition.

**4.7 Lemma** The function  $d$  above is a determinant. Hence determinants exist for every  $n$ .

PROOF We'll must check that it has the four properties from the definition.

Property (4) is easy; where  $I$  is the  $n \times n$  identity, in

$$d(I) = \sum_{\text{perm } \phi} t_{1,\phi(1)} t_{2,\phi(2)} \cdots t_{n,\phi(n)} \text{sgn}(\phi)$$

all of the terms in the summation are zero except for the product down the diagonal, which is one.

For property (3) consider  $d(\hat{T})$  where  $T \xrightarrow{k\rho_i} \hat{T}$ .

$$\begin{aligned} \sum_{\text{perm } \phi} \hat{t}_{1,\phi(1)} \cdots \hat{t}_{i,\phi(i)} \cdots \hat{t}_{n,\phi(n)} \text{sgn}(\phi) \\ = \sum_{\phi} t_{1,\phi(1)} \cdots k t_{i,\phi(i)} \cdots t_{n,\phi(n)} \text{sgn}(\phi) \end{aligned}$$

Factor out the  $k$  to get the desired equality.

$$= k \cdot \sum_{\phi} t_{1,\phi(1)} \cdots t_{i,\phi(i)} \cdots t_{n,\phi(n)} \text{sgn}(\phi) = k \cdot d(T)$$

For (2) suppose that  $T \xrightarrow{\rho_i \leftrightarrow \rho_j} \hat{T}$ . We must show this is the negative of  $d(T)$ .

$$d(\hat{T}) = \sum_{\text{perm } \phi} \hat{t}_{1,\phi(1)} \cdots \hat{t}_{i,\phi(i)} \cdots \hat{t}_{j,\phi(j)} \cdots \hat{t}_{n,\phi(n)} \text{sgn}(\phi) \quad (*)$$

We will show that each term in  $(*)$  is associated with a term in  $d(t)$ , and that the two terms are negatives of each other. Consider the matrix from the multilinear



expansion of  $d(\hat{T})$  giving the term  $\hat{t}_{1,\phi(1)} \cdots \hat{t}_{i,\phi(i)} \cdots \hat{t}_{j,\phi(j)} \cdots \hat{t}_{n,\phi(n)} \operatorname{sgn}(\phi)$ .

$$\begin{pmatrix} \vdots \\ \hat{t}_{i,\phi(i)} \\ \vdots \\ \hat{t}_{j,\phi(j)} \\ \vdots \end{pmatrix}$$

It is the result of the  $\rho_i \leftrightarrow \rho_j$  operation performed on this matrix.

$$\begin{pmatrix} \vdots \\ t_{i,\phi(j)} \\ \vdots \\ t_{j,\phi(i)} \\ \vdots \end{pmatrix}$$

That is, the term with hatted  $t$ 's is associated with this term from the  $d(T)$  expansion:  $t_{1,\sigma(1)} \cdots t_{j,\sigma(j)} \cdots t_{i,\sigma(i)} \cdots t_{n,\sigma(n)} \operatorname{sgn}(\sigma)$ , where the permutation  $\sigma$  equals  $\phi$  but with the  $i$ -th and  $j$ -th numbers interchanged,  $\sigma(i) = \phi(j)$  and  $\sigma(j) = \phi(i)$ . The two terms have the same multiplicands  $\hat{t}_{1,\phi(1)} = t_{1,\sigma(1)}$ ,  $\dots$ , including the entries from the swapped rows  $\hat{t}_{i,\phi(i)} = t_{j,\phi(i)} = t_{j,\sigma(j)}$  and  $\hat{t}_{j,\phi(j)} = t_{i,\phi(j)} = t_{i,\sigma(i)}$ . But the two terms are negatives of each other since  $\operatorname{sgn}(\phi) = -\operatorname{sgn}(\sigma)$  by Lemma 4.3.

Now, any permutation  $\phi$  can be derived from some other permutation  $\sigma$  by such a swap, in one and only one way. Therefore the summation in (\*) is in fact a sum over all permutations, taken once and only once.

$$\begin{aligned} d(\hat{T}) &= \sum_{\text{perm } \phi} \hat{t}_{1,\phi(1)} \cdots \hat{t}_{i,\phi(i)} \cdots \hat{t}_{j,\phi(j)} \cdots \hat{t}_{n,\phi(n)} \operatorname{sgn}(\phi) \\ &= \sum_{\text{perm } \sigma} t_{1,\sigma(1)} \cdots t_{j,\sigma(j)} \cdots t_{i,\sigma(i)} \cdots t_{n,\sigma(n)} \cdot (-\operatorname{sgn}(\sigma)) \end{aligned}$$

Thus  $d(\hat{T}) = -d(T)$ .

To do property (1) suppose that  $T \xrightarrow{k\rho_i + \rho_j} \hat{T}$  and consider the effect of a row combination.

$$\begin{aligned} d(\hat{T}) &= \sum_{\text{perm } \phi} \hat{t}_{1,\phi(1)} \cdots \hat{t}_{i,\phi(i)} \cdots \hat{t}_{j,\phi(j)} \cdots \hat{t}_{n,\phi(n)} \operatorname{sgn}(\phi) \\ &= \sum_{\phi} t_{1,\phi(1)} \cdots t_{i,\phi(i)} \cdots (kt_{i,\phi(j)} + t_{j,\phi(j)}) \cdots t_{n,\phi(n)} \operatorname{sgn}(\phi) \end{aligned}$$

Do the algebra.

$$\begin{aligned}
&= \sum_{\phi} [t_{1,\phi(1)} \cdots t_{i,\phi(i)} \cdots k t_{i,\phi(j)} \cdots t_{n,\phi(n)} \operatorname{sgn}(\phi) \\
&\quad + t_{1,\phi(1)} \cdots t_{i,\phi(i)} \cdots t_{j,\phi(j)} \cdots t_{n,\phi(n)} \operatorname{sgn}(\phi)] \\
&= \sum_{\phi} t_{1,\phi(1)} \cdots t_{i,\phi(i)} \cdots k t_{i,\phi(j)} \cdots t_{n,\phi(n)} \operatorname{sgn}(\phi) \\
&\quad + \sum_{\phi} t_{1,\phi(1)} \cdots t_{i,\phi(i)} \cdots t_{j,\phi(j)} \cdots t_{n,\phi(n)} \operatorname{sgn}(\phi) \\
&= k \cdot \sum_{\phi} t_{1,\phi(1)} \cdots t_{i,\phi(i)} \cdots t_{i,\phi(j)} \cdots t_{n,\phi(n)} \operatorname{sgn}(\phi) \\
&\quad + d(T)
\end{aligned}$$

Finish by observing that the terms  $t_{1,\phi(1)} \cdots t_{i,\phi(i)} \cdots t_{i,\phi(j)} \cdots t_{n,\phi(n)} \operatorname{sgn}(\phi)$  add to zero: this sum represents  $d(S)$  where  $S$  is a matrix equal to  $T$  except that row  $j$  of  $S$  is a copy of row  $i$  of  $T$  (because the factor is  $t_{i,\phi(j)}$ , not  $t_{j,\phi(j)}$ ) and so  $S$  has two equal rows, rows  $i$  and  $j$ . Since we have already shown that  $d$  changes sign on row swaps, as in Lemma 2.4 we conclude that  $d(S) = 0$ . QED

We have now shown that determinant functions exist for each size. We already know that for each size there is at most one determinant. Therefore, the permutation expansion computes the one and only determinant.

We end this subsection by proving the other result remaining from the prior subsection.

**4.8 Theorem** The determinant of a matrix equals the determinant of its transpose.

PROOF Call the matrix  $T$  and denote the entries of  $T^{\text{trans}}$  with  $s$ 's so that  $t_{i,j} = s_{j,i}$ . Substitution gives this

$$|T| = \sum_{\text{perms } \phi} t_{1,\phi(1)} \cdots t_{n,\phi(n)} \operatorname{sgn}(\phi) = \sum_{\phi} s_{\phi(1),1} \cdots s_{\phi(n),n} \operatorname{sgn}(\phi)$$

and we will finish the argument by manipulating the expression on the right to be recognizable as the determinant of the transpose. We have written all permutation expansions with the row indices ascending. To rewrite the expression on the right in this way, note that because  $\phi$  is a permutation the row indices  $\phi(1), \dots, \phi(n)$  are just the numbers  $1, \dots, n$ , rearranged. Apply commutativity to have these ascend, giving  $s_{1,\phi^{-1}(1)} \cdots s_{n,\phi^{-1}(n)}$ .

$$= \sum_{\phi^{-1}} s_{1,\phi^{-1}(1)} \cdots s_{n,\phi^{-1}(n)} \operatorname{sgn}(\phi^{-1})$$

Exercise 14 shows that  $\operatorname{sgn}(\phi^{-1}) = \operatorname{sgn}(\phi)$ . Since every permutation is the inverse of another, a sum over all inverses  $\phi^{-1}$  is a sum over all permutations

$$= \sum_{\text{perms } \sigma} s_{1,\sigma(1)} \cdots s_{n,\sigma(n)} \operatorname{sgn}(\sigma) = |T^{\text{trans}}|$$

as required.

QED

## Exercises

These summarize the notation used in this book for the 2- and 3- permutations.

i	1	2
$\phi_1(i)$	1	2
$\phi_2(i)$	2	1

i	1	2	3
$\phi_1(i)$	1	2	3
$\phi_2(i)$	1	3	2
$\phi_3(i)$	2	1	3
$\phi_4(i)$	2	3	1
$\phi_5(i)$	3	1	2
$\phi_6(i)$	3	2	1

- 4.9 Give the permutation expansion of a general  $2 \times 2$  matrix and its transpose.
- ✓ 4.10 This problem appears also in the prior subsection.
- (a) Find the inverse of each 2-permutation.
- (b) Find the inverse of each 3-permutation.
- ✓ 4.11 (a) Find the signum of each 2-permutation.
- (b) Find the signum of each 3-permutation.
- 4.12 Find the only nonzero term in the permutation expansion of this matrix.

$$\begin{vmatrix} 0 & 1 & 0 & 0 \\ 1 & 0 & 1 & 0 \\ 0 & 1 & 0 & 1 \\ 0 & 0 & 1 & 0 \end{vmatrix}$$

Compute that determinant by finding the signum of the associated permutation.

- 4.13 [Strang 80] What is the signum of the  $n$ -permutation  $\phi = \langle n, n-1, \dots, 2, 1 \rangle$ ?
- 4.14 Prove these.
- (a) Every permutation has an inverse.
- (b)  $\text{sgn}(\phi^{-1}) = \text{sgn}(\phi)$
- (c) Every permutation is the inverse of another.
- 4.15 Prove that the matrix of the permutation inverse is the transpose of the matrix of the permutation  $P_{\phi^{-1}} = P_{\phi}^{\text{trans}}$ , for any permutation  $\phi$ .
- ✓ 4.16 Show that a permutation matrix with  $m$  inversions can be row swapped to the identity in  $m$  steps. Contrast this with Corollary 4.4.
- ✓ 4.17 For any permutation  $\phi$  let  $g(\phi)$  be the integer defined in this way.

$$g(\phi) = \prod_{i < j} [\phi(j) - \phi(i)]$$

(This is the product, over all indices  $i$  and  $j$  with  $i < j$ , of terms of the given form.)

- (a) Compute the value of  $g$  on all 2-permutations.
- (b) Compute the value of  $g$  on all 3-permutations.
- (c) Prove that  $g(\phi)$  is not 0.
- (d) Prove this.

$$\text{sgn}(\phi) = \frac{g(\phi)}{|g(\phi)|}$$

Many authors give this formula as the definition of the signum function.

## II Geometry of Determinants

The prior section develops the determinant algebraically, by considering formulas satisfying certain properties. This section complements that with a geometric approach. One advantage of this approach is that while we have so far only considered whether or not a determinant is zero, here we shall give a meaning to the value of the determinant. (The prior section treats determinants as functions of the rows but in this section we focus on columns.)

### II.1 Determinants as Size Functions

This parallelogram picture is familiar from the construction of the sum of the two vectors.

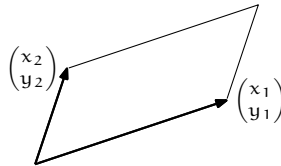

**1.1 Definition** In  $\mathbb{R}^n$  the *box* (or *parallelepiped*) formed by  $\langle \vec{v}_1, \dots, \vec{v}_n \rangle$  is the set  $\{t_1\vec{v}_1 + \dots + t_n\vec{v}_n \mid t_1, \dots, t_n \in [0..1]\}$ .

Thus, the parallelogram shown above is the box defined by  $\langle \begin{pmatrix} x_1 \\ y_1 \end{pmatrix}, \begin{pmatrix} x_2 \\ y_2 \end{pmatrix} \rangle$ .

We are interested in the area of the box. One way to compute it is to draw this rectangle and subtract the area of each subregion.

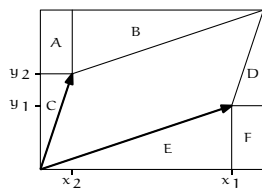

area of parallelogram

$$\begin{aligned} &= \text{area of rectangle} - \text{area of A} - \text{area of B} \\ &\quad - \dots - \text{area of F} \\ &= (x_1 + x_2)(y_1 + y_2) - x_2y_1 - x_1y_1/2 \\ &\quad - x_2y_2/2 - x_2y_2/2 - x_1y_1/2 - x_2y_1 \\ &= x_1y_2 - x_2y_1 \end{aligned}$$

The fact that the area equals the value of the determinant

$$\begin{vmatrix} x_1 & x_2 \\ y_1 & y_2 \end{vmatrix} = x_1y_2 - x_2y_1$$

is no coincidence. The properties from the definition of determinants make good postulates for a function that measures the size of the box defined by the matrix's columns.

For instance, a function that measures the size of the box should have the property that multiplying one of the box-defining vectors by a scalar (here  $k = 1.4$ ) will multiply the size by that scalar.

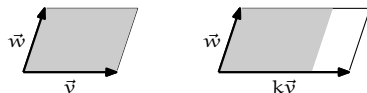

(On the right the rescaled region is in solid lines with the original region in shade for comparison.) That is, we can reasonably expect of a size measure that  $\text{size}(\dots, k\vec{v}, \dots) = k \cdot \text{size}(\dots, \vec{v}, \dots)$ . Of course, this property is familiar from the definition of determinants.

Another property of determinants that should apply to any function giving the size of a box is that it is unaffected by combining rows. Here are before-combining and after-combining boxes (the scalar shown is  $k = 0.35$ ). The box formed by  $\vec{v}$  and  $k\vec{v} + \vec{w}$  is more slanted than the original one but the two have the same base and the same height and hence the same area.

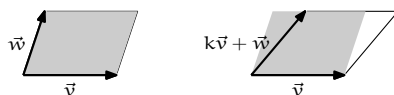

(As before, the figure on the right has the original region in shade for comparison.) So we expect that  $\text{size}(\dots, \vec{v}, \dots, \vec{w}, \dots) = \text{size}(\dots, \vec{v}, \dots, k\vec{v} + \vec{w}, \dots)$ ; again, a restatement of a determinant postulate.

Lastly, we expect that  $\text{size}(\vec{e}_1, \vec{e}_2) = 1$



and we naturally extend that to any number of dimensions  $\text{size}(\vec{e}_1, \dots, \vec{e}_n) = 1$ .

Because property (2) of determinants is redundant (as remarked following the definition) we have that the properties of the determinant function are reasonable to expect of a function that gives the size of boxes. The prior section starts with these properties and shows that the determinant exists and is unique, so we know that these postulates are consistent and that we do not need any more postulates. Thus, we will interpret  $\det(\vec{v}_1, \dots, \vec{v}_n)$  as the size of the box formed by the vectors.

**1.2 Remark** Although property (2) of the definition of determinants is redundant, it raises an important point. Consider these two.

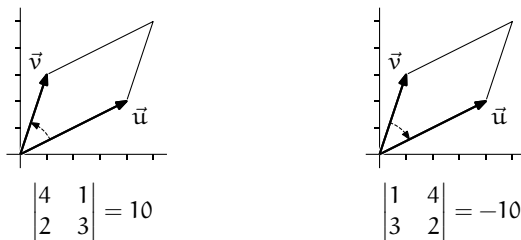

Swapping changes the sign. If we take  $\vec{u}$  first and then  $\vec{v}$ , following the counterclockwise arc, then the sign is positive. Following the clockwise arc gives a negative sign. The sign returned by the size function reflects the *orientation*

or *sense* of the box. (We see the same thing if we picture the effect of scalar multiplication by a negative scalar.)

Although it is both interesting and important, we don't need the idea of orientation for the development below and so we will pass it by. (See Exercise 27.)

**1.3 Definition** The *volume* of a box is the absolute value of the determinant of a matrix with those vectors as columns.

**1.4 Example** By the formula that takes the area of the base times the height, the volume of this parallelepiped is 12. That agrees with the determinant.

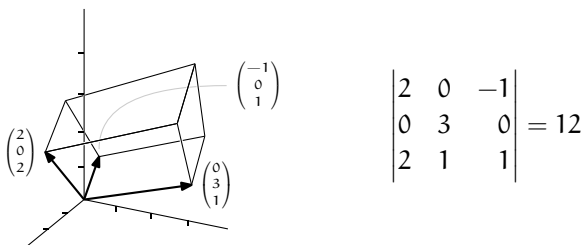

We can also compute the volume as the absolute value of this determinant.

$$\begin{vmatrix} 0 & 2 & 0 \\ 3 & 0 & 3 \\ 1 & 2 & 1 \end{vmatrix} = -12$$

The next result describes some of the geometry of the linear functions that act on  $\mathbb{R}^n$ .

**1.5 Theorem** A transformation  $t: \mathbb{R}^n \rightarrow \mathbb{R}^n$  changes the size of all boxes by the same factor, namely the size of the image of a box  $|t(S)|$  is  $|T|$  times the size of the box  $|S|$ , where  $T$  is the matrix representing  $t$  with respect to the standard basis.

That is, for all  $n \times n$  matrices, the determinant of a product is the product of the determinants  $|TS| = |T| \cdot |S|$ .

The two sentences say the same thing, first in map terms and then in matrix terms. This is because  $|t(S)| = |TS|$ , as both give the size of the box that is the image of the unit box  $\mathcal{E}_n$  under the composition  $t \circ s$  (where  $s$  is the map represented by  $S$  with respect to the standard basis).

**PROOF** First consider the  $|T| = 0$  case. A matrix has a zero determinant if and only if it is not invertible. Observe that if  $TS$  is invertible then there is an  $M$  such that  $(TS)M = I$ , so  $T(SM) = I$ , which shows that  $T$  is invertible, with inverse  $SM$ . By contrapositive, if  $T$  is not invertible then neither is  $TS$ —if  $|T| = 0$  then  $|TS| = 0$ .

Now consider the case that  $|T| \neq 0$ , that  $T$  is nonsingular. Recall that any nonsingular matrix factors into a product of elementary matrices  $T = E_1 E_2 \cdots E_r$ . To finish this argument we will verify that  $|ES| = |E| \cdot |S|$  for all matrices  $S$  and

elementary matrices  $E$ . The result will then follow because  $|TS| = |E_1 \cdots E_r S| = |E_1| \cdots |E_r| \cdot |S| = |E_1 \cdots E_r| \cdot |S| = |T| \cdot |S|$ .

There are three kinds of elementary matrix. We will cover the  $M_i(k)$  case; the  $P_{i,j}$  and  $C_{i,j}(k)$  checks are similar. We have that  $M_i(k)S$  equals  $S$  except that row  $i$  is multiplied by  $k$ . The third property of determinant functions then gives that  $|M_i(k)S| = k \cdot |S|$ . But  $|M_i(k)| = k$ , again by the third property because  $M_i(k)$  is derived from the identity by multiplication of row  $i$  by  $k$ . Thus  $|ES| = |E| \cdot |S|$  holds for  $E = M_i(k)$ . QED

**1.6 Example** Application of the map  $t$  represented with respect to the standard bases by

$$\begin{pmatrix} 1 & 1 \\ -2 & 0 \end{pmatrix}$$

will double sizes of boxes, e.g., from this

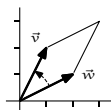

$$\begin{vmatrix} 2 & 1 \\ 1 & 2 \end{vmatrix} = 3$$

to this

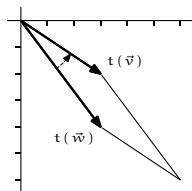

$$\begin{vmatrix} 3 & 3 \\ -4 & -2 \end{vmatrix} = 6$$

**1.7 Corollary** If a matrix is invertible then the determinant of its inverse is the inverse of its determinant  $|T^{-1}| = 1/|T|$ .

PROOF  $1 = |I| = |TT^{-1}| = |T| \cdot |T^{-1}|$

QED

Recall that determinants are not additive homomorphisms, that  $\det(A + B)$  need not equal  $\det(A) + \det(B)$ . In contrast, the above theorem says that determinants are multiplicative homomorphisms:  $\det(AB)$  equals  $\det(A) \cdot \det(B)$ .

**Exercises**

**1.8** Find the volume of the region defined by the vectors.

- (a)  $\langle \begin{pmatrix} 1 \\ 3 \end{pmatrix}, \begin{pmatrix} -1 \\ 4 \end{pmatrix} \rangle$
- (b)  $\langle \begin{pmatrix} 2 \\ 1 \\ 0 \end{pmatrix}, \begin{pmatrix} 3 \\ -2 \\ 4 \end{pmatrix}, \begin{pmatrix} 8 \\ -3 \\ 8 \end{pmatrix} \rangle$
- (c)  $\langle \begin{pmatrix} 1 \\ 2 \\ 0 \\ 1 \end{pmatrix}, \begin{pmatrix} 2 \\ 2 \\ 2 \\ 2 \end{pmatrix}, \begin{pmatrix} -1 \\ 3 \\ 0 \\ 5 \end{pmatrix}, \begin{pmatrix} 0 \\ 1 \\ 0 \\ 7 \end{pmatrix} \rangle$

- ✓ 1.9 Is

$$\begin{pmatrix} 4 \\ 1 \\ 2 \end{pmatrix}$$

inside of the box formed by these three?

$$\begin{pmatrix} 3 \\ 3 \\ 1 \end{pmatrix} \quad \begin{pmatrix} 2 \\ 6 \\ 1 \end{pmatrix} \quad \begin{pmatrix} 1 \\ 0 \\ 5 \end{pmatrix}$$

- ✓ 1.10 Find the volume of this region.

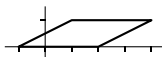

- ✓ 1.11 Suppose that  $|A| = 3$ . By what factor do these change volumes?

(a)  $A$     (b)  $A^2$     (c)  $A^{-2}$

- ✓ 1.12 By what factor does each transformation change the size of boxes?

(a)  $\begin{pmatrix} x \\ y \end{pmatrix} \mapsto \begin{pmatrix} 2x \\ 3y \end{pmatrix}$     (b)  $\begin{pmatrix} x \\ y \end{pmatrix} \mapsto \begin{pmatrix} 3x - y \\ -2x + y \end{pmatrix}$     (c)  $\begin{pmatrix} x \\ y \\ z \end{pmatrix} \mapsto \begin{pmatrix} x - y \\ x + y + z \\ y - 2z \end{pmatrix}$

- 1.13 What is the area of the image of the rectangle  $[2..4] \times [2..5]$  under the action of this matrix?

$$\begin{pmatrix} 2 & 3 \\ 4 & -1 \end{pmatrix}$$

- 1.14 If  $t: \mathbb{R}^3 \rightarrow \mathbb{R}^3$  changes volumes by a factor of 7 and  $s: \mathbb{R}^3 \rightarrow \mathbb{R}^3$  changes volumes by a factor of  $3/2$  then by what factor will their composition change volumes?

- 1.15 In what way does the definition of a box differ from the definition of a span?

- ✓ 1.16 Why doesn't this picture contradict Theorem 1.5?

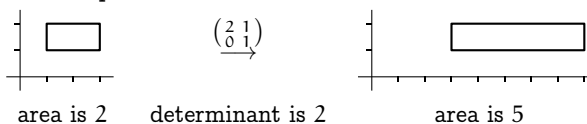

- ✓ 1.17 Does  $|TS| = |ST|$ ?  $|T(SP)| = |(TS)P|$ ?

- 1.18 (a) Suppose that  $|A| = 3$  and that  $|B| = 2$ . Find  $|A^2 \cdot B^{\text{trans}} \cdot B^{-2} \cdot A^{\text{trans}}|$ .

- (b) Assume that  $|A| = 0$ . Prove that  $|6A^3 + 5A^2 + 2A| = 0$ .

- ✓ 1.19 Let  $T$  be the matrix representing (with respect to the standard bases) the map that rotates plane vectors counterclockwise thru  $\theta$  radians. By what factor does  $T$  change sizes?

- ✓ 1.20 Must a transformation  $t: \mathbb{R}^2 \rightarrow \mathbb{R}^2$  that preserves areas also preserve lengths?

- ✓ 1.21 What is the volume of a parallelepiped in  $\mathbb{R}^3$  bounded by a linearly dependent set?

- ✓ 1.22 Find the area of the triangle in  $\mathbb{R}^3$  with endpoints  $(1, 2, 1)$ ,  $(3, -1, 4)$ , and  $(2, 2, 2)$ . (Area, not volume. The triangle defines a plane—what is the area of the triangle in that plane?)

- ✓ 1.23 An alternate proof of Theorem 1.5 uses the definition of determinant functions.

- (a) Note that the vectors forming  $S$  make a linearly dependent set if and only if  $|S| = 0$ , and check that the result holds in this case.

- (b) For the  $|S| \neq 0$  case, to show that  $|TS|/|S| = |T|$  for all transformations, consider the function  $d: \mathcal{M}_{n \times n} \rightarrow \mathbb{R}$  given by  $T \mapsto |TS|/|S|$ . Show that  $d$  has the first property of a determinant.



(c) Show that  $d$  has the remaining three properties of a determinant function.

(d) Conclude that  $|TS| = |T| \cdot |S|$ .

1.24 Give a non-identity matrix with the property that  $A^{\text{trans}} = A^{-1}$ . Show that if  $A^{\text{trans}} = A^{-1}$  then  $|A| = \pm 1$ . Does the converse hold?

1.25 The algebraic property of determinants that factoring a scalar out of a single row will multiply the determinant by that scalar shows that where  $H$  is  $3 \times 3$ , the determinant of  $cH$  is  $c^3$  times the determinant of  $H$ . Explain this geometrically, that is, using Theorem 1.5. (The observation that increasing the linear size of a three-dimensional object by a factor of  $c$  will increase its volume by a factor of  $c^3$  while only increasing its surface area by an amount proportional to a factor of  $c^2$  is the *Square-cube law* [Wikipedia Square-cube Law].)

✓ 1.26 We say that matrices  $H$  and  $G$  are *similar* if there is a nonsingular matrix  $P$  such that  $H = P^{-1}GP$  (we will study this relation in Chapter Five). Show that similar matrices have the same determinant.

1.27 We usually represent vectors in  $\mathbb{R}^2$  with respect to the standard basis so vectors in the first quadrant have both coordinates positive.

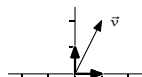

$$\text{Rep}_{\mathcal{E}_2}(\vec{v}) = \begin{pmatrix} +3 \\ +2 \end{pmatrix}$$

Moving counterclockwise around the origin, we cycle thru four regions:

$$\dots \rightarrow \begin{pmatrix} + \\ + \end{pmatrix} \rightarrow \begin{pmatrix} - \\ + \end{pmatrix} \rightarrow \begin{pmatrix} - \\ - \end{pmatrix} \rightarrow \begin{pmatrix} + \\ - \end{pmatrix} \rightarrow \dots$$

Using this basis

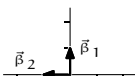
$$B = \left\langle \begin{pmatrix} 0 \\ 1 \end{pmatrix}, \begin{pmatrix} -1 \\ 0 \end{pmatrix} \right\rangle$$

gives the same counterclockwise cycle. We say these two bases have the same *orientation*.

(a) Why do they give the same cycle?

(b) What other configurations of unit vectors on the axes give the same cycle?

(c) Find the determinants of the matrices formed from those (ordered) bases.

(d) What other counterclockwise cycles are possible, and what are the associated determinants?

(e) What happens in  $\mathbb{R}^1$ ?

(f) What happens in  $\mathbb{R}^3$ ?

A fascinating general-audience discussion of orientations is in [Gardner].

1.28 This question uses material from the optional *Determinant Functions Exist subsection*. Prove Theorem 1.5 by using the permutation expansion formula for the determinant.

✓ 1.29 (a) Show that this gives the equation of a line in  $\mathbb{R}^2$  thru  $(x_2, y_2)$  and  $(x_3, y_3)$ .

$$\begin{vmatrix} x & x_2 & x_3 \\ y & y_2 & y_3 \\ 1 & 1 & 1 \end{vmatrix} = 0$$

(b) [Petersen] Prove that the area of a triangle with vertices  $(x_1, y_1)$ ,  $(x_2, y_2)$ , and  $(x_3, y_3)$  is

$$\frac{1}{2} \begin{vmatrix} x_1 & x_2 & x_3 \\ y_1 & y_2 & y_3 \\ 1 & 1 & 1 \end{vmatrix}.$$

(c) [Math. Mag., Jan. 1973] Prove that the area of a triangle with vertices at  $(x_1, y_1)$ ,  $(x_2, y_2)$ , and  $(x_3, y_3)$  whose coordinates are integers has an area of  $N$  or  $N/2$  for some positive integer  $N$ .

### III Laplace's Expansion

Determinants are a font of interesting and amusing formulas. Here is one that is often used to compute determinants by hand.

#### III.1 Laplace's Expansion Formula

1.1 Example In this permutation expansion

$$\begin{aligned} \begin{vmatrix} t_{1,1} & t_{1,2} & t_{1,3} \\ t_{2,1} & t_{2,2} & t_{2,3} \\ t_{3,1} & t_{3,2} & t_{3,3} \end{vmatrix} &= t_{1,1}t_{2,2}t_{3,3} \begin{vmatrix} 1 & 0 & 0 \\ 0 & 1 & 0 \\ 0 & 0 & 1 \end{vmatrix} + t_{1,1}t_{2,3}t_{3,2} \begin{vmatrix} 1 & 0 & 0 \\ 0 & 0 & 1 \\ 0 & 1 & 0 \end{vmatrix} \\ &\quad + t_{1,2}t_{2,1}t_{3,3} \begin{vmatrix} 0 & 1 & 0 \\ 1 & 0 & 0 \\ 0 & 0 & 1 \end{vmatrix} + t_{1,2}t_{2,3}t_{3,1} \begin{vmatrix} 0 & 1 & 0 \\ 0 & 0 & 1 \\ 1 & 0 & 0 \end{vmatrix} \\ &\quad + t_{1,3}t_{2,1}t_{3,2} \begin{vmatrix} 0 & 0 & 1 \\ 1 & 0 & 0 \\ 0 & 1 & 0 \end{vmatrix} + t_{1,3}t_{2,2}t_{3,1} \begin{vmatrix} 0 & 0 & 1 \\ 0 & 1 & 0 \\ 1 & 0 & 0 \end{vmatrix} \end{aligned}$$

we can factor out the entries from the first row

$$\begin{aligned} &= t_{1,1} \cdot \left[ \begin{vmatrix} t_{2,2}t_{3,3} & 1 & 0 & 0 \\ 0 & 1 & 0 & 0 \\ 0 & 0 & 1 & 0 \end{vmatrix} + \begin{vmatrix} t_{2,3}t_{3,2} & 1 & 0 & 0 \\ 0 & 0 & 1 & 0 \\ 0 & 1 & 0 & 0 \end{vmatrix} \right] \\ &\quad + t_{1,2} \cdot \left[ \begin{vmatrix} t_{2,1}t_{3,3} & 0 & 1 & 0 \\ t_{2,1}t_{3,3} & 1 & 0 & 0 \\ 0 & 0 & 1 & 0 \end{vmatrix} + \begin{vmatrix} t_{2,3}t_{3,1} & 0 & 1 & 0 \\ t_{2,3}t_{3,1} & 0 & 0 & 1 \\ 1 & 0 & 0 & 0 \end{vmatrix} \right] \\ &\quad + t_{1,3} \cdot \left[ \begin{vmatrix} t_{2,1}t_{3,2} & 0 & 0 & 1 \\ t_{2,1}t_{3,2} & 1 & 0 & 0 \\ 0 & 1 & 0 & 0 \end{vmatrix} + \begin{vmatrix} t_{2,2}t_{3,1} & 0 & 0 & 1 \\ t_{2,2}t_{3,1} & 0 & 1 & 0 \\ 1 & 0 & 0 & 0 \end{vmatrix} \right] \end{aligned}$$

and in the permutation matrices swap to get the first rows into place.

$$\begin{aligned} &= t_{1,1} \cdot \left[ \begin{vmatrix} t_{2,2}t_{3,3} & 1 & 0 & 0 \\ 0 & 1 & 0 & 0 \\ 0 & 0 & 1 & 0 \end{vmatrix} + \begin{vmatrix} t_{2,3}t_{3,2} & 1 & 0 & 0 \\ 0 & 0 & 1 & 0 \\ 0 & 1 & 0 & 0 \end{vmatrix} \right] \\ &\quad - t_{1,2} \cdot \left[ \begin{vmatrix} t_{2,1}t_{3,3} & 1 & 0 & 0 \\ t_{2,1}t_{3,3} & 0 & 1 & 0 \\ 0 & 0 & 1 & 0 \end{vmatrix} + \begin{vmatrix} t_{2,3}t_{3,1} & 1 & 0 & 0 \\ t_{2,3}t_{3,1} & 0 & 0 & 1 \\ 0 & 1 & 0 & 0 \end{vmatrix} \right] \\ &\quad + t_{1,3} \cdot \left[ \begin{vmatrix} t_{2,1}t_{3,2} & 1 & 0 & 0 \\ t_{2,1}t_{3,2} & 0 & 1 & 0 \\ 0 & 0 & 1 & 0 \end{vmatrix} + \begin{vmatrix} t_{2,2}t_{3,1} & 1 & 0 & 0 \\ t_{2,2}t_{3,1} & 0 & 0 & 1 \\ 0 & 1 & 0 & 0 \end{vmatrix} \right] \end{aligned}$$

The point of the swapping (one swap to each of the permutation matrices on the second line and two swaps to each on the third line) is that the three lines simplify to three terms.

$$= t_{1,1} \cdot \begin{vmatrix} t_{2,2} & t_{2,3} \\ t_{3,2} & t_{3,3} \end{vmatrix} - t_{1,2} \cdot \begin{vmatrix} t_{2,1} & t_{2,3} \\ t_{3,1} & t_{3,3} \end{vmatrix} + t_{1,3} \cdot \begin{vmatrix} t_{2,1} & t_{2,2} \\ t_{3,1} & t_{3,2} \end{vmatrix}$$

The formula given in Theorem 1.5, which generalizes this example, is a *recurrence*—the determinant is expressed as a combination of determinants. This formula isn't circular because, as here, the determinant is expressed in terms of determinants of matrices of smaller size.

**1.2 Definition** For any  $n \times n$  matrix  $T$ , the  $(n-1) \times (n-1)$  matrix formed by deleting row  $i$  and column  $j$  of  $T$  is the  $i, j$  *minor* of  $T$ . The  $i, j$  *cofactor*  $T_{i,j}$  of  $T$  is  $(-1)^{i+j}$  times the determinant of the  $i, j$  minor of  $T$ .

**1.3 Example** The 1, 2 cofactor of the matrix from Example 1.1 is the negative of the second  $2 \times 2$  determinant.

$$T_{1,2} = -1 \cdot \begin{vmatrix} t_{2,1} & t_{2,3} \\ t_{3,1} & t_{3,3} \end{vmatrix}$$

**1.4 Example** Where

$$T = \begin{pmatrix} 1 & 2 & 3 \\ 4 & 5 & 6 \\ 7 & 8 & 9 \end{pmatrix}$$

these are the 1, 2 and 2, 2 cofactors.

$$T_{1,2} = (-1)^{1+2} \cdot \begin{vmatrix} 4 & 6 \\ 7 & 9 \end{vmatrix} = 6 \quad T_{2,2} = (-1)^{2+2} \cdot \begin{vmatrix} 1 & 3 \\ 7 & 9 \end{vmatrix} = -12$$

**1.5 Theorem (Laplace Expansion of Determinants)** Where  $T$  is an  $n \times n$  matrix, we can find the determinant by expanding by cofactors on any row  $i$  or column  $j$ .

$$\begin{aligned} |T| &= t_{i,1} \cdot T_{i,1} + t_{i,2} \cdot T_{i,2} + \cdots + t_{i,n} \cdot T_{i,n} \\ &= t_{1,j} \cdot T_{1,j} + t_{2,j} \cdot T_{2,j} + \cdots + t_{n,j} \cdot T_{n,j} \end{aligned}$$

PROOF Exercise 27.

QED

**1.6 Example** We can compute the determinant

$$|T| = \begin{vmatrix} 1 & 2 & 3 \\ 4 & 5 & 6 \\ 7 & 8 & 9 \end{vmatrix}$$

by expanding along the first row, as in Example 1.1.

$$|T| = 1 \cdot (+1) \begin{vmatrix} 5 & 6 \\ 8 & 9 \end{vmatrix} + 2 \cdot (-1) \begin{vmatrix} 4 & 6 \\ 7 & 9 \end{vmatrix} + 3 \cdot (+1) \begin{vmatrix} 4 & 5 \\ 7 & 8 \end{vmatrix} = -3 + 12 - 9 = 0$$

Alternatively, we can expand down the second column.

$$|T| = 2 \cdot (-1) \begin{vmatrix} 4 & 6 \\ 7 & 9 \end{vmatrix} + 5 \cdot (+1) \begin{vmatrix} 1 & 3 \\ 7 & 9 \end{vmatrix} + 8 \cdot (-1) \begin{vmatrix} 1 & 3 \\ 4 & 6 \end{vmatrix} = 12 - 60 + 48 = 0$$

**1.7 Example** A row or column with many zeroes suggests a Laplace expansion.

$$\begin{vmatrix} 1 & 5 & 0 \\ 2 & 1 & 1 \\ 3 & -1 & 0 \end{vmatrix} = 0 \cdot (+1) \begin{vmatrix} 2 & 1 \\ 3 & -1 \end{vmatrix} + 1 \cdot (-1) \begin{vmatrix} 1 & 5 \\ 3 & -1 \end{vmatrix} + 0 \cdot (+1) \begin{vmatrix} 1 & 5 \\ 2 & 1 \end{vmatrix} = 16$$

We finish by applying this result to derive a new formula for the inverse of a matrix. With Theorem 1.5, we can calculate the determinant of an  $n \times n$  matrix  $T$  by taking linear combinations of entries from a row and their associated cofactors.

$$t_{i,1} \cdot T_{i,1} + t_{i,2} \cdot T_{i,2} + \cdots + t_{i,n} \cdot T_{i,n} = |T| \quad (*)$$

Recall that a matrix with two identical rows has a zero determinant. Thus, for any matrix  $T$ , weighing the cofactors by entries from the “wrong” row — row  $k$  with  $k \neq i$  — gives zero

$$t_{i,1} \cdot T_{k,1} + t_{i,2} \cdot T_{k,2} + \cdots + t_{i,n} \cdot T_{k,n} = 0 \quad (**)$$

because it represents the expansion along the row  $k$  of a matrix with row  $i$  equal to row  $k$ . This equation summarizes  $(*)$  and  $(**)$ .

$$\begin{pmatrix} t_{1,1} & t_{1,2} & \cdots & t_{1,n} \\ t_{2,1} & t_{2,2} & \cdots & t_{2,n} \\ \vdots & \vdots & \ddots & \vdots \\ t_{n,1} & t_{n,2} & \cdots & t_{n,n} \end{pmatrix} \begin{pmatrix} T_{1,1} & T_{2,1} & \cdots & T_{n,1} \\ T_{1,2} & T_{2,2} & \cdots & T_{n,2} \\ \vdots & \vdots & \ddots & \vdots \\ T_{1,n} & T_{2,n} & \cdots & T_{n,n} \end{pmatrix} = \begin{pmatrix} |T| & 0 & \cdots & 0 \\ 0 & |T| & \cdots & 0 \\ \vdots & \vdots & \ddots & \vdots \\ 0 & 0 & \cdots & |T| \end{pmatrix}$$

Note that the order of the subscripts in the matrix of cofactors is opposite to the order of subscripts in the other matrix; e.g., along the first row of the matrix of cofactors the subscripts are 1, 1 then 2, 1, etc.

**1.8 Definition** The matrix *adjoint* to the square matrix  $T$  is

$$\text{adj}(T) = \begin{pmatrix} T_{1,1} & T_{2,1} & \cdots & T_{n,1} \\ T_{1,2} & T_{2,2} & \cdots & T_{n,2} \\ \vdots & \vdots & \ddots & \vdots \\ T_{1,n} & T_{2,n} & \cdots & T_{n,n} \end{pmatrix}$$

where  $T_{j,i}$  is the  $j, i$  cofactor.

**1.9 Theorem** Where  $T$  is a square matrix,  $T \cdot \text{adj}(T) = \text{adj}(T) \cdot T = |T| \cdot I$ .

PROOF Equations  $(*)$  and  $(**)$ .

QED

**1.10 Example** If

$$T = \begin{pmatrix} 1 & 0 & 4 \\ 2 & 1 & -1 \\ 1 & 0 & 1 \end{pmatrix}$$

then  $\text{adj}(T)$  is

$$\begin{pmatrix} T_{1,1} & T_{2,1} & T_{3,1} \\ T_{1,2} & T_{2,2} & T_{3,2} \\ T_{1,3} & T_{2,3} & T_{3,3} \end{pmatrix} = \begin{pmatrix} \begin{vmatrix} 1 & -1 \\ 0 & 1 \end{vmatrix} & -\begin{vmatrix} 0 & 4 \\ 0 & 1 \end{vmatrix} & \begin{vmatrix} 0 & 4 \\ 1 & -1 \end{vmatrix} \\ -\begin{vmatrix} 2 & -1 \\ 1 & 1 \end{vmatrix} & \begin{vmatrix} 1 & 4 \\ 1 & 1 \end{vmatrix} & -\begin{vmatrix} 1 & 4 \\ 2 & -1 \end{vmatrix} \\ \begin{vmatrix} 2 & 1 \\ 1 & 0 \end{vmatrix} & -\begin{vmatrix} 1 & 0 \\ 1 & 0 \end{vmatrix} & \begin{vmatrix} 1 & 0 \\ 2 & 1 \end{vmatrix} \end{pmatrix} = \begin{pmatrix} 1 & 0 & -4 \\ -3 & -3 & 9 \\ -1 & 0 & 1 \end{pmatrix}$$

and taking the product with  $T$  gives the diagonal matrix  $|T| \cdot I$ .

$$\begin{pmatrix} 1 & 0 & 4 \\ 2 & 1 & -1 \\ 1 & 0 & 1 \end{pmatrix} \begin{pmatrix} 1 & 0 & -4 \\ -3 & -3 & 9 \\ -1 & 0 & 1 \end{pmatrix} = \begin{pmatrix} -3 & 0 & 0 \\ 0 & -3 & 0 \\ 0 & 0 & -3 \end{pmatrix}$$

**1.11 Corollary** If  $|T| \neq 0$  then  $T^{-1} = (1/|T|) \cdot \text{adj}(T)$ .

**1.12 Example** The inverse of the matrix from Example 1.10 is  $(1/-3) \cdot \text{adj}(T)$ .

$$T^{-1} = \begin{pmatrix} 1/-3 & 0/-3 & -4/-3 \\ -3/-3 & -3/-3 & 9/-3 \\ -1/-3 & 0/-3 & 1/-3 \end{pmatrix} = \begin{pmatrix} -1/3 & 0 & 4/3 \\ 1 & 1 & -3 \\ 1/3 & 0 & -1/3 \end{pmatrix}$$

The formulas from this section are often used for by-hand calculation and are sometimes useful with special types of matrices. However, they are not the best choice for computation with arbitrary matrices because they require more arithmetic than, for instance, the Gauss-Jordan method.

### Exercises

✓ **1.13** Find the cofactor.

$$T = \begin{pmatrix} 1 & 0 & 2 \\ -1 & 1 & 3 \\ 0 & 2 & -1 \end{pmatrix}$$

(a)  $T_{2,3}$    (b)  $T_{3,2}$    (c)  $T_{1,3}$

✓ **1.14** Find the determinant by expanding

$$\begin{vmatrix} 3 & 0 & 1 \\ 1 & 2 & 2 \\ -1 & 3 & 0 \end{vmatrix}$$

(a) on the first row   (b) on the second row   (c) on the third column.

**1.15** Find the adjoint of the matrix in Example 1.6.

✓ **1.16** Find the matrix adjoint to each.

$$(a) \begin{pmatrix} 2 & 1 & 4 \\ -1 & 0 & 2 \\ 1 & 0 & 1 \end{pmatrix} \quad (b) \begin{pmatrix} 3 & -1 \\ 2 & 4 \end{pmatrix} \quad (c) \begin{pmatrix} 1 & 1 \\ 5 & 0 \end{pmatrix} \quad (d) \begin{pmatrix} 1 & 4 & 3 \\ -1 & 0 & 3 \\ 1 & 8 & 9 \end{pmatrix}$$

✓ 1.17 Find the inverse of each matrix in the prior question with Theorem 1.9.

1.18 Find the matrix adjoint to this one.

$$\begin{pmatrix} 2 & 1 & 0 & 0 \\ 1 & 2 & 1 & 0 \\ 0 & 1 & 2 & 1 \\ 0 & 0 & 1 & 2 \end{pmatrix}$$

✓ 1.19 Expand across the first row to derive the formula for the determinant of a  $2 \times 2$  matrix.

✓ 1.20 Expand across the first row to derive the formula for the determinant of a  $3 \times 3$  matrix.

✓ 1.21 (a) Give a formula for the adjoint of a  $2 \times 2$  matrix.

(b) Use it to derive the formula for the inverse.

✓ 1.22 Can we compute a determinant by expanding down the diagonal?

1.23 Give a formula for the adjoint of a diagonal matrix.

✓ 1.24 Prove that the transpose of the adjoint is the adjoint of the transpose.

1.25 Prove or disprove:  $\text{adj}(\text{adj}(T)) = T$ .

1.26 A square matrix is *upper triangular* if each  $i, j$  entry is zero in the part above the diagonal, that is, when  $i > j$ .

(a) Must the adjoint of an upper triangular matrix be upper triangular? Lower triangular?

(b) Prove that the inverse of a upper triangular matrix is upper triangular, if an inverse exists.

1.27 This question requires material from the optional *Determinants Exist subsection*. Prove Theorem 1.5 by using the permutation expansion.

1.28 Prove that the determinant of a matrix equals the determinant of its transpose using Laplace's expansion and induction on the size of the matrix.

? 1.29 Show that

$$F_n = \begin{vmatrix} 1 & -1 & 1 & -1 & 1 & -1 & \dots \\ 1 & 1 & 0 & 1 & 0 & 1 & \dots \\ 0 & 1 & 1 & 0 & 1 & 0 & \dots \\ 0 & 0 & 1 & 1 & 0 & 1 & \dots \\ \cdot & \cdot & \cdot & \cdot & \cdot & \cdot & \dots \end{vmatrix}$$

where  $F_n$  is the  $n$ -th term of  $1, 1, 2, 3, 5, \dots, x, y, x + y, \dots$ , the Fibonacci sequence, and the determinant is of order  $n - 1$ . [*Am. Math. Mon.*, Jun. 1949]

## Topic

---

# Cramer's Rule

We have seen that a linear system

$$\begin{aligned}x_1 + 2x_2 &= 6 \\ 3x_1 + x_2 &= 8\end{aligned}$$

is equivalent to a linear relationship among vectors.

$$x_1 \cdot \begin{pmatrix} 1 \\ 3 \end{pmatrix} + x_2 \cdot \begin{pmatrix} 2 \\ 1 \end{pmatrix} = \begin{pmatrix} 6 \\ 8 \end{pmatrix}$$

This pictures that vector equation. A parallelogram with sides formed from  $\begin{pmatrix} 1 \\ 3 \end{pmatrix}$  and  $\begin{pmatrix} 2 \\ 1 \end{pmatrix}$  is nested inside a parallelogram with sides formed from  $x_1 \begin{pmatrix} 1 \\ 3 \end{pmatrix}$  and  $x_2 \begin{pmatrix} 2 \\ 1 \end{pmatrix}$ .

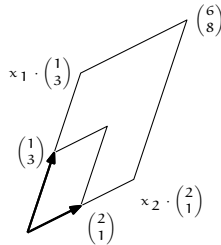

That is, we can restate the algebraic question of finding the solution of a linear system in geometric terms: by what factors  $x_1$  and  $x_2$  must we dilate the vectors to expand the small parallelogram so that it will fill the larger one?

We can apply the geometric significance of determinants to that picture to get a new formula. Compare the sizes of these shaded boxes.

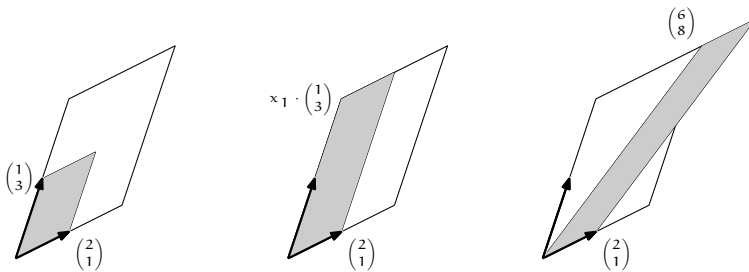

The second is defined by the vectors  $x_1 \begin{pmatrix} 1 \\ 3 \end{pmatrix}$  and  $\begin{pmatrix} 2 \\ 1 \end{pmatrix}$ , and one of the properties of the size function—the determinant—is that therefore the size of the second box is  $x_1$  times the size of the first box. Since the third box is defined by the vector  $x_1 \begin{pmatrix} 1 \\ 3 \end{pmatrix} + x_2 \begin{pmatrix} 2 \\ 1 \end{pmatrix} = \begin{pmatrix} 6 \\ 8 \end{pmatrix}$  and the vector  $\begin{pmatrix} 2 \\ 1 \end{pmatrix}$ , and since the determinant does not change when we add  $x_2$  times the second column to the first column, the size of the third box equals that of the second.

$$\begin{vmatrix} 6 & 2 \\ 8 & 1 \end{vmatrix} = \begin{vmatrix} x_1 \cdot 1 & 2 \\ x_1 \cdot 3 & 1 \end{vmatrix} = x_1 \cdot \begin{vmatrix} 1 & 2 \\ 3 & 1 \end{vmatrix}$$

Solving gives the value of one of the variables.

$$x_1 = \frac{\begin{vmatrix} 6 & 2 \\ 8 & 1 \end{vmatrix}}{\begin{vmatrix} 1 & 2 \\ 3 & 1 \end{vmatrix}} = \frac{-10}{-5} = 2$$

The generalization of this example is *Cramer's Rule*: if  $|A| \neq 0$  then the system  $A\vec{x} = \vec{b}$  has the unique solution  $x_i = |B_i|/|A|$  where the matrix  $B_i$  is formed from  $A$  by replacing column  $i$  with the vector  $\vec{b}$ . The proof is Exercise 3.

For instance, to solve this system for  $x_2$

$$\begin{pmatrix} 1 & 0 & 4 \\ 2 & 1 & -1 \\ 1 & 0 & 1 \end{pmatrix} \begin{pmatrix} x_1 \\ x_2 \\ x_3 \end{pmatrix} = \begin{pmatrix} 2 \\ 1 \\ -1 \end{pmatrix}$$

we do this computation.

$$x_2 = \frac{\begin{vmatrix} 1 & 2 & 4 \\ 2 & 1 & -1 \\ 1 & -1 & 1 \end{vmatrix}}{\begin{vmatrix} 1 & 0 & 4 \\ 2 & 1 & -1 \\ 1 & 0 & 1 \end{vmatrix}} = \frac{-18}{-3}$$

Cramer's Rule allows us to solve simple two equations/two unknowns systems by eye (they must be simple in that we can mentally compute with the numbers in the system). With practice a person can also do simple three equations/three unknowns systems. But computing large determinants takes a long time so solving large systems by Cramer's Rule is not practical.

### Exercises

- 1 Use Cramer's Rule to solve each for each of the variables.



$$\begin{array}{ll} \text{(a)} & \begin{array}{l} x - y = 4 \\ -x + 2y = -7 \end{array} \\ \text{(b)} & \begin{array}{l} -2x + y = -2 \\ x - 2y = -2 \end{array} \end{array}$$

2 Use Cramer's Rule to solve this system for  $z$ .

$$\begin{array}{r} 2x + y + z = 1 \\ 3x \quad + z = 4 \\ x - y - z = 2 \end{array}$$

3 Prove Cramer's Rule.

4 Suppose that a linear system has as many equations as unknowns, that all of its coefficients and constants are integers, and that its matrix of coefficients has determinant 1. Prove that the entries in the solution are all integers. (*Remark.* This is often used to invent linear systems for exercises. If an instructor makes the linear system with this property then the solution is not some disagreeable fraction.)

5 Use Cramer's Rule to give a formula for the solution of a two equations/two unknowns linear system.

6 Can Cramer's Rule tell the difference between a system with no solutions and one with infinitely many?

7 The first picture in this Topic (the one that doesn't use determinants) shows a unique solution case. Produce a similar picture for the case of infinitely many solutions, and the case of no solutions.

## Speed of Calculating Determinants

The permutation expansion formula for computing determinants is useful for proving theorems, but the method of using row operations is a much better for finding the determinants of a large matrix. We can make this statement precise by considering, as computer algorithm designers do, the number of arithmetic operations that each method uses.

We measure the speed of an algorithm by finding how the time taken by the computer grows as the size of its input data set grows. For instance, if we increase the size of the input data by a factor of ten does the time taken by the computer grow by a factor of ten, or by a factor of a hundred, or by a factor of a thousand? That is, is the time proportional to the size of the data set, or to the square of that size, or to the cube of that size, etc.?

Recall the permutation expansion formula for determinants.

$$\begin{vmatrix} t_{1,1} & t_{1,2} & \dots & t_{1,n} \\ t_{2,1} & t_{2,2} & \dots & t_{2,n} \\ \vdots & & & \\ t_{n,1} & t_{n,2} & \dots & t_{n,n} \end{vmatrix} = \sum_{\text{permutations } \phi} t_{1,\phi(1)} t_{2,\phi(2)} \cdots t_{n,\phi(n)} |P_\phi|$$

There are  $n! = n \cdot (n-1) \cdot (n-2) \cdots 2 \cdot 1$  different  $n$ -permutations. This factorial function grows quickly; for instance when  $n$  is only 10 then the expansion above has  $10! = 3,628,800$  terms, each with  $n$  multiplications. Doing  $n!$  many operations is doing more than  $n^2$  many operations (roughly: multiplying the first two factors in  $n!$  gives  $n \cdot (n-1)$ , which for large  $n$  is approximately  $n^2$  and then multiplying in more factors will make the factorial even larger). Similarly, the factorial function grows faster than the cube or the fourth power or any polynomial function. So a computer program that uses the permutation expansion formula, and thus performs a number of operations that is greater than or equal to the factorial of the number of rows, would be very slow. It would take a time longer than the square of the number of rows, longer than the cube, etc.

In contrast, the time taken by the row reduction method does not grow so fast. The fragment of row-reduction code shown below is in the computer language FORTRAN, which is widely used for numeric code. The matrix is in

the  $N \times N$  array  $A$ . The program's outer loop runs through each  $ROW$  between 1 and  $N-1$  and does the entry-by-entry combination  $-\text{PIVINV} \cdot \rho_{ROW} + \rho_I$  with the lower rows.

```
DO 10 ROW=1, N-1
  PIVINV=1.0/A(ROW,ROW)
  DO 20 I=ROW+1, N
    DO 30 J=I, N
      A(I,J)=A(I,J)-PIVINV*A(ROW,J)
    30 CONTINUE
  20 CONTINUE
10 CONTINUE
```

(This code is naive; for example it does not handle the case that the  $A(ROW,ROW)$  is zero. Analysis of a finished version that includes all of the tests and subcases is messier but gives the same conclusion.) For each  $ROW$ , the nested  $I$  and  $J$  loops perform the combination with the lower rows by doing arithmetic on the entries in  $A$  that are below and to the right of  $A(ROW,ROW)$ . There are  $(N - ROW)^2$  such entries. On average,  $ROW$  will be  $N/2$ . Therefore, this program will perform the arithmetic about  $(N/2)^2$  times, that is, this program will run in a time proportional to the square of the number of equations. Taking into account the outer loop, we estimate that the running time of the algorithm is proportional to the cube of the number of equations.

Finding the fastest algorithm to compute the determinant is a topic of current research. So far, people have found algorithms that run in time between the square and cube of  $N$ .

The contrast between these two methods for computing determinants makes the point that although in principle they give the same answer, in practice we want the one that is fast.

### Exercises

*Most of these presume access to a computer.*

1 Computer systems generate random numbers (of course, these are only pseudo-random, in that they come from an algorithm, but they pass a number of reasonable statistical tests for randomness).

(a) Fill a  $5 \times 5$  array with random numbers (say, in the range  $[0..1)$ ). See if it is singular. Repeat that experiment a few times. Are singular matrices frequent or rare (in this sense)?

(b) Time your computer algebra system at finding the determinant of ten  $5 \times 5$  arrays of random numbers. Find the average time per array. Repeat the prior item for  $15 \times 15$  arrays,  $25 \times 25$  arrays,  $35 \times 35$  arrays, etc. You may find that you need to get above a certain size to get a timing that you can use. (Notice that, when an array is singular, we can sometimes decide that quickly, for instance if the first row equals the second. In the light of your answer to the first part, do you expect that singular systems play a large role in your average?)

(c) Graph the input size versus the average time.

2 Compute the determinant of each of these by hand using the two methods discussed above.

$$(a) \begin{vmatrix} 2 & 1 \\ 5 & -3 \end{vmatrix} \quad (b) \begin{vmatrix} 3 & 1 & 1 \\ -1 & 0 & 5 \\ -1 & 2 & -2 \end{vmatrix} \quad (c) \begin{vmatrix} 2 & 1 & 0 & 0 \\ 1 & 3 & 2 & 0 \\ 0 & -1 & -2 & 1 \\ 0 & 0 & -2 & 1 \end{vmatrix}$$

Count the number of multiplications and divisions used in each case, for each of the methods. (On a computer, multiplications and divisions take much longer than additions and subtractions, so algorithm designers worry about them more.)

- 3 What  $10 \times 10$  array can you invent that takes your computer system the longest to reduce? The shortest?
- 4 The FORTRAN language specification requires that arrays be stored “by column,” that is, the entire first column is stored contiguously, then the second column, etc. Does the code fragment given take advantage of this, or can it be rewritten to make it faster, by taking advantage of the fact that computer fetches are faster from contiguous locations?

## Topic

---

# Projective Geometry

There are geometries other than the familiar Euclidean one. One such geometry arose in art, where people observed that what a viewer sees is not necessarily what is there. This is Leonardo da Vinci's *The Last Supper*.

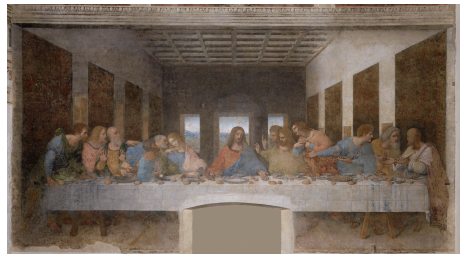

Look at where the ceiling meets the left and right walls. In the room those lines are parallel but as viewers we see lines that, if extended, would intersect. The intersection point is the *vanishing point*. This aspect of perspective is familiar as an image of railroad tracks that appear to converge at the horizon.

To depict the room da Vinci has adopted a model of how we see, of how we project the three dimensional scene to a two dimensional image. This model is only a first approximation: it does not take into account the curve of our retina, that our lens bends the light, that we have binocular vision, or that our brain's processing greatly affects what we see. Nonetheless it is interesting, both artistically and mathematically.

This is a *central projection* from a single point to the plane of the canvas.

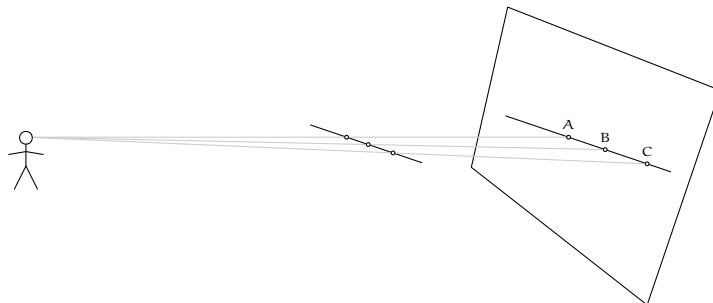

It is not a orthogonal projection since the line from the viewer to  $C$  is not orthogonal to the image plane.

The operation of central projection preserves some geometric properties, for instance lines project to lines. However, it fails to preserve some others, for instance equal length segments can project to segments of unequal length ( $AB$  is longer than  $BC$ , because the segment projected to  $AB$  is closer to the viewer and closer things look bigger). The study of the effects of central projections is projective geometry.

There are three cases of central projection. The first is the projection done by a movie projector.

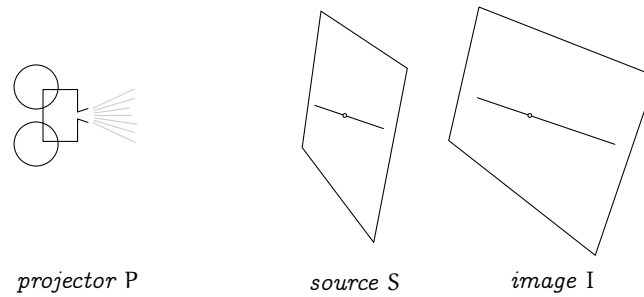

We can think that each source point is “pushed” from the domain plane outward to the image point in the codomain plane. The second case of projection is that of the artist “pulling” the source back to the canvas.

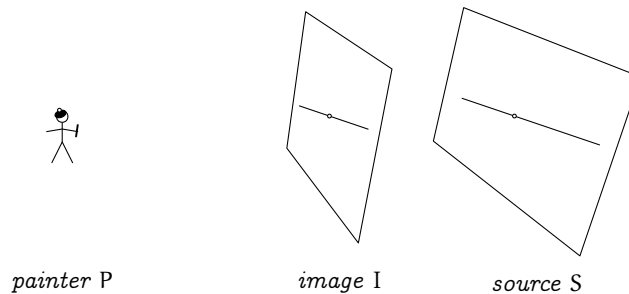

The two are different because in the first case  $S$  is in the middle while in the second case  $I$  is in the middle. One more configuration is possible, with  $P$  in the middle. An example of this is when we use a pinhole to shine the image of a solar eclipse onto a piece of paper.

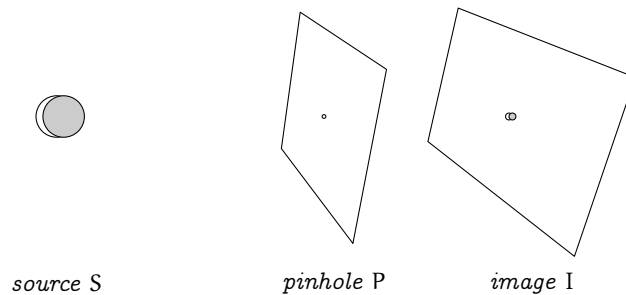

Although the three are not exactly the same, they are similar. We shall say that each is a central projection by  $P$  of  $S$  to  $I$ . We next look at three models of central projection, of increasing abstractness but also of increasing uniformity. The last will bring out the linear algebra.

Consider again the effect of railroad tracks that appear to converge to a point. We model this with parallel lines in a domain plane  $S$  and a projection via a  $P$  to a codomain plane  $I$ . (The gray lines are parallel to  $S$  and  $I$  planes.)

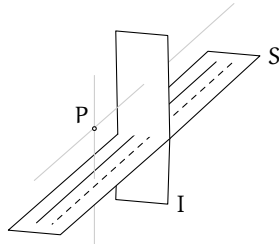

All three projection cases appear in this one setting. The first picture below shows  $P$  acting as a movie projector by pushing points from part of  $S$  out to image points on the lower half of  $I$ . The middle picture shows  $P$  acting as the artist by pulling points from another part of  $S$  back to image points in the middle of  $I$ . In the third picture  $P$  acts as the pinhole, projecting points from  $S$  to the upper part of  $I$ . This third picture is the trickiest—the points that are projected near to the vanishing point are the ones that are far out on the bottom left of  $S$ . Points in  $S$  that are near to the vertical gray line are sent high up on  $I$ .

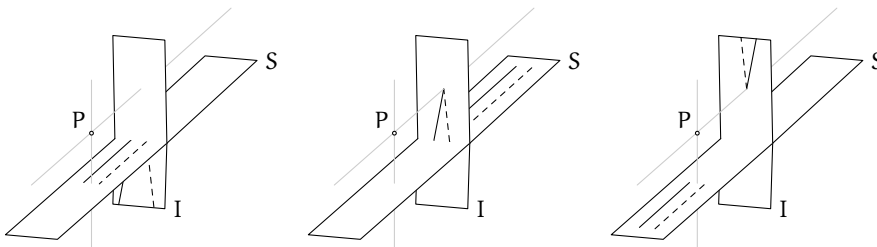

There are two awkward things about this situation. The first is that neither of the two points in the domain nearest to the vertical gray line (see below) has an image because a projection from those two is along the gray line that is parallel to the codomain plane (we sometimes say that these two are projected to infinity). The second awkward thing is that the vanishing point in  $I$  isn't the image of any point from  $S$  because a projection to this point would be along the gray line that is parallel to the domain plane (we sometimes say that the vanishing point is the image of a projection "from infinity").

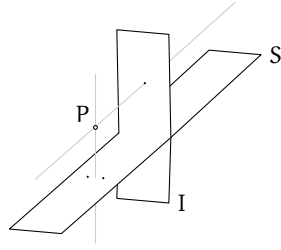

For a model that eliminates this awkwardness, put the projector  $P$  at the origin. Imagine that we cover  $P$  with a glass hemispheric dome. As  $P$  looks outward, anything in the line of vision is projected to the same spot on the dome. This includes things on the line between  $P$  and the dome, as in the case of projection by the movie projector. It includes things on the line further from  $P$  than the dome, as in the case of projection by the painter. It also includes things on the line that lie behind  $P$ , as in the case of projection by a pinhole.

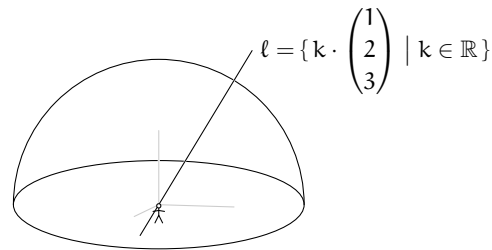

From this perspective  $P$ , all of the spots on the line are the same point. Accordingly, for any nonzero vector  $\vec{v} \in \mathbb{R}^3$ , we define the associated *point  $v$  in the projective plane* to be the set  $\{k\vec{v} \mid k \in \mathbb{R} \text{ and } k \neq 0\}$  of nonzero vectors lying on the same line through the origin as  $\vec{v}$ . To describe a projective point we can give any representative member of the line, so that the projective point shown above can be represented in any of these three ways.

$$\begin{pmatrix} 1 \\ 2 \\ 3 \end{pmatrix} \quad \begin{pmatrix} 1/3 \\ 2/3 \\ 1 \end{pmatrix} \quad \begin{pmatrix} -2 \\ -4 \\ -6 \end{pmatrix}$$

Each of these is a *homogeneous coordinate vector* for  $v$ .

This picture and definition clarifies the description of central projection but there is something awkward about the dome model: what if the viewer looks down? If we draw  $P$ 's line of sight so that the part coming toward us, out of the page, goes down below the dome then we can trace the line of sight backward, up past  $P$  and toward the part of the hemisphere that is behind the page. So in the dome model, looking down gives a projective point that is behind the viewer. Therefore, if the viewer in the picture above drops the line of sight toward the bottom of the dome then the projective point drops also and as the line of sight continues down past the equator, the projective point suddenly shifts from the front of the dome to the back of the dome. (This brings out that



in fact the dome is not quite an entire hemisphere, or else when the viewer is looking exactly along the equator then there are two points in the line on the dome. Instead we define it so that the points on the equator with a positive  $y$  coordinate, as well as the point where  $y = 0$  and  $x$  is positive, are on the dome but the other equatorial points are not.) This discontinuity means that we often have to treat equatorial points as a separate case. That is, while the railroad track discussion of central projection has three cases, the dome model has two.

We can do better, we can reduce to having no separate cases. Consider a sphere centered at the origin. Any line through the origin intersects the sphere in two spots, which are *antipodal*. Because we associate each line through the origin with a point in the projective plane, we can draw such a point as a pair of antipodal spots on the sphere. Below, we show the two antipodal spots connected by a dashed line to emphasize that they are not two different points, the pair of spots together make one projective point.

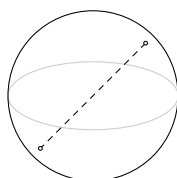

While drawing a point as a pair of antipodal spots is not as natural as the one-spot-per-point dome mode, on the other hand the awkwardness of the dome model is gone, in that if as a line of view slides from north to south, no sudden changes happen. This model of central projection is uniform.

So far we have described points in projective geometry. What about lines? What a viewer at the origin sees as a line is shown below as a great circle, the intersection of the model sphere with a plane through the origin.

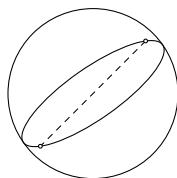

(We've included one of the projective points on this line to bring out a subtlety. Because two antipodal spots together make up a single projective point, the great circle's behind-the-paper part is the same set of projective points as its in-front-of-the-paper part.) Just as we did with each projective point, we will also describe a projective line with a triple of reals. For instance, the members of this plane through the origin in  $\mathbb{R}^3$

$$\left\{ \begin{pmatrix} x \\ y \\ z \end{pmatrix} \mid x + y - z = 0 \right\}$$

project to a line that we can describe with the row vector  $\begin{pmatrix} 1 & 1 & -1 \end{pmatrix}$  (we use a row vector to typographically set lines apart from points). In general, for any nonzero three-wide row vector  $\vec{L}$  we define the associated *line in the projective plane*, to be the set  $L = \{k\vec{L} \mid k \in \mathbb{R} \text{ and } k \neq 0\}$  of nonzero multiples of  $\vec{L}$ .

The reason that this description of a line as a triple is convenient is that in the projective plane, a point  $v$  and a line  $L$  are *incident*—the point lies on the line, the line passes through the point—if and only if a dot product of their representatives  $v_1L_1 + v_2L_2 + v_3L_3$  is zero (Exercise 4 shows that this is independent of the choice of representatives  $\vec{v}$  and  $\vec{L}$ ). For instance, the projective point described above by the column vector with components 1, 2, and 3 lies in the projective line described by  $\begin{pmatrix} 1 & 1 & -1 \end{pmatrix}$ , simply because any vector in  $\mathbb{R}^3$  whose components are in ratio 1 : 2 : 3 lies in the plane through the origin whose equation is of the form  $1k \cdot x + 1k \cdot y - 1k \cdot z = 0$  for any nonzero  $k$ . That is, the incidence formula is inherited from the three-space lines and planes of which  $v$  and  $L$  are projections.

Thus, we can do analytic projective geometry. For instance, the projective line  $L = \begin{pmatrix} 1 & 1 & -1 \end{pmatrix}$  has the equation  $1v_1 + 1v_2 - 1v_3 = 0$ , because points incident on the line have the property that their representatives satisfy this equation. One difference from familiar Euclidean analytic geometry is that in projective geometry we talk about the equation of a point. For a fixed point like

$$v = \begin{pmatrix} 1 \\ 2 \\ 3 \end{pmatrix}$$

the property that characterizes lines through this point (that is, lines incident on this point) is that the components of any representatives satisfy  $1L_1 + 2L_2 + 3L_3 = 0$  and so this is the equation of  $v$ .

This symmetry of the statements about lines and points brings up the *Duality Principle* of projective geometry: in any true statement, interchanging ‘point’ with ‘line’ results in another true statement. For example, just as two distinct points determine one and only one line, in the projective plane two distinct lines determine one and only one point. Here is a picture showing two lines that cross in antipodal spots and thus cross at one projective point.

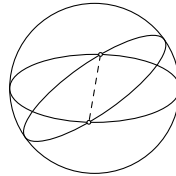

(\*)

Contrast this with Euclidean geometry, where two distinct lines may have a unique intersection or may be parallel. In this way, projective geometry is simpler, more uniform, than Euclidean geometry.

That simplicity is relevant because there is a relationship between the two spaces: we can view the projective plane as an extension of the Euclidean plane.

Take the sphere model of the projective plane to be the unit sphere in  $\mathbb{R}^3$  and take Euclidean space to be the plane  $z = 1$ . This gives us a way of viewing some points in projective space as corresponding to points in Euclidean space, because all of the points on the plane are projections of antipodal spots from the sphere.

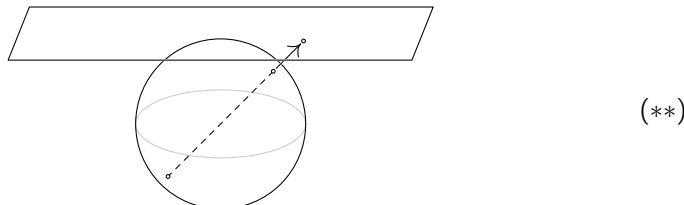

Note though that projective points on the equator don't project up to the plane. Instead, these project 'out to infinity'. We can thus think of projective space as consisting of the Euclidean plane with some extra points adjoined—the Euclidean plane is embedded in the projective plane. These extra points, the equatorial points, are the *ideal points* or *points at infinity* and the equator is the *ideal line* or *line at infinity* (it is not a Euclidean line, it is a projective line).

The advantage of the extension to the projective plane is that some of the awkwardness of Euclidean geometry disappears. For instance, the projective lines shown above in (\*) cross at antipodal spots, a single projective point, on the sphere's equator. If we put those lines into (\*\*) then they correspond to Euclidean lines that are parallel. That is, in moving from the Euclidean plane to the projective plane, we move from having two cases, that lines either intersect or are parallel, to having only one case, that lines intersect (possibly at a point at infinity).

The projective case is nicer in many ways than the Euclidean case but has the problem that we don't have the same experience or intuitions with it. That's one advantage of doing analytic geometry where the equations can lead us to the right conclusions. Analytic projective geometry uses linear algebra. For instance, for three points of the projective plane  $t$ ,  $u$ , and  $v$ , setting up the equations for those points by fixing vectors representing each, shows that the three are collinear—incident in a single line—if and only if the resulting three-equation system has infinitely many row vector solutions representing that line. That, in turn, holds if and only if this determinant is zero.

$$\begin{vmatrix} t_1 & u_1 & v_1 \\ t_2 & u_2 & v_2 \\ t_3 & u_3 & v_3 \end{vmatrix}$$

Thus, three points in the projective plane are collinear if and only if any three representative column vectors are linearly dependent. Similarly (and illustrating the Duality Principle), three lines in the projective plane are incident on a single point if and only if any three row vectors representing them are linearly dependent.

The following result is more evidence of the niceness of the geometry of the projective plane, compared with the Euclidean case. These two triangles *in perspective* from the point O because their corresponding vertices are collinear.

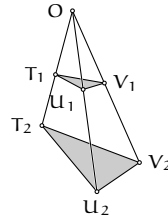

Consider the pairs of corresponding sides: the sides  $T_1U_1$  and  $T_2U_2$ , the sides  $T_1V_1$  and  $T_2V_2$ , and the sides  $U_1V_1$  and  $U_2V_2$ . Desargue's Theorem is that when we extend the three pairs of corresponding sides to full lines, they intersect (shown here as the point TU, the point TV, and the point UV), and further, those three intersection points are collinear.

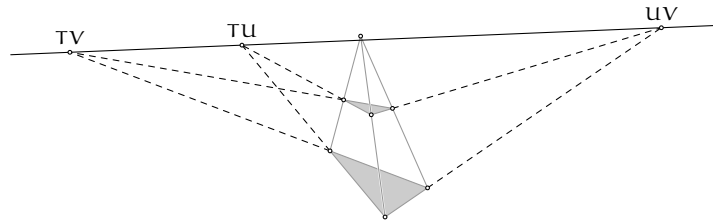

We will prove this theorem, using projective geometry. (We've drawn these as Euclidean figures because it is the more familiar image. To consider them as projective figures, we can imagine that, although the line segments shown are parts of great circles and so are curved, the model has such a large radius compared to the size of the figures that the sides appear in this sketch to be straight.)

For this proof we need a preliminary lemma [Coxeter]: if  $W, X, Y, Z$  are four points in the projective plane (no three of which are collinear) then there are homogeneous coordinate vectors  $\vec{w}, \vec{x}, \vec{y},$  and  $\vec{z}$  for the projective points, and a basis  $B$  for  $\mathbb{R}^3$ , satisfying this.

$$\text{Rep}_B(\vec{w}) = \begin{pmatrix} 1 \\ 0 \\ 0 \end{pmatrix} \quad \text{Rep}_B(\vec{x}) = \begin{pmatrix} 0 \\ 1 \\ 0 \end{pmatrix} \quad \text{Rep}_B(\vec{y}) = \begin{pmatrix} 0 \\ 0 \\ 1 \end{pmatrix} \quad \text{Rep}_B(\vec{z}) = \begin{pmatrix} 1 \\ 1 \\ 1 \end{pmatrix}$$

For the proof, because  $W, X,$  and  $Y$  are not on the same projective line, any homogeneous coordinate vectors  $\vec{w}_0, \vec{x}_0,$  and  $\vec{y}_0$  do not line on the same plane through the origin in  $\mathbb{R}^3$  and so form a spanning set for  $\mathbb{R}^3$ . Thus any homogeneous coordinate vector for  $Z$  is a combination  $\vec{z}_0 = a \cdot \vec{w}_0 + b \cdot \vec{x}_0 + c \cdot \vec{y}_0$ . Then, we can take  $\vec{w} = a \cdot \vec{w}_0, \vec{x} = b \cdot \vec{x}_0, \vec{y} = c \cdot \vec{y}_0,$  and  $\vec{z} = \vec{z}_0$ , where the basis is  $B = \langle \vec{w}, \vec{x}, \vec{y} \rangle$ .

Now, to prove Desargue's Theorem use the lemma to fix homogeneous coordinate vectors and a basis.

$$\text{Rep}_B(\vec{t}_1) = \begin{pmatrix} 1 \\ 0 \\ 0 \end{pmatrix} \quad \text{Rep}_B(\vec{u}_1) = \begin{pmatrix} 0 \\ 1 \\ 0 \end{pmatrix} \quad \text{Rep}_B(\vec{v}_1) = \begin{pmatrix} 0 \\ 0 \\ 1 \end{pmatrix} \quad \text{Rep}_B(\vec{o}) = \begin{pmatrix} 1 \\ 1 \\ 1 \end{pmatrix}$$

Because the projective point  $T_2$  is incident on the projective line  $OT_1$ , any homogeneous coordinate vector for  $T_2$  lies in the plane through the origin in  $\mathbb{R}^3$  that is spanned by homogeneous coordinate vectors of  $O$  and  $T_1$ :

$$\text{Rep}_B(\vec{t}_2) = a \begin{pmatrix} 1 \\ 1 \\ 1 \end{pmatrix} + b \begin{pmatrix} 1 \\ 0 \\ 0 \end{pmatrix}$$

for some scalars  $a$  and  $b$ . That is, the homogeneous coordinate vectors of members  $T_2$  of the line  $OT_1$  are of the form on the left below, and the forms for  $U_2$  and  $V_2$  are similar.

$$\text{Rep}_B(\vec{t}_2) = \begin{pmatrix} t_2 \\ 1 \\ 1 \end{pmatrix} \quad \text{Rep}_B(\vec{u}_2) = \begin{pmatrix} 1 \\ u_2 \\ 1 \end{pmatrix} \quad \text{Rep}_B(\vec{v}_2) = \begin{pmatrix} 1 \\ 1 \\ v_2 \end{pmatrix}$$

The projective line  $T_1U_1$  is the image of a plane through the origin in  $\mathbb{R}^3$ . One way to get its equation is to note that any vector in it is linearly dependent on the vectors for  $T_1$  and  $U_1$  and so this determinant is zero.

$$\begin{vmatrix} 1 & 0 & x \\ 0 & 1 & y \\ 0 & 0 & z \end{vmatrix} = 0 \quad \implies \quad z = 0$$

The equation of the plane in  $\mathbb{R}^3$  whose image is the projective line  $T_2U_2$  is this.

$$\begin{vmatrix} t_2 & 1 & x \\ 1 & u_2 & y \\ 1 & 1 & z \end{vmatrix} = 0 \quad \implies \quad (1 - u_2) \cdot x + (1 - t_2) \cdot y + (t_2 u_2 - 1) \cdot z = 0$$

Finding the intersection of the two is routine.

$$T_1U_1 \cap T_2U_2 = \begin{pmatrix} t_2 - 1 \\ 1 - u_2 \\ 0 \end{pmatrix}$$

(This is, of course, the homogeneous coordinate vector of a projective point.)

The other two intersections are similar.

$$T_1V_1 \cap T_2V_2 = \begin{pmatrix} 1 - t_2 \\ 0 \\ v_2 - 1 \end{pmatrix} \quad U_1V_1 \cap U_2V_2 = \begin{pmatrix} 0 \\ u_2 - 1 \\ 1 - v_2 \end{pmatrix}$$

Finish the proof by noting that these projective points are on one projective line because the sum of the three homogeneous coordinate vectors is zero.

Every projective theorem has a translation to a Euclidean version, although the Euclidean result may be messier to state and prove. Desargue's theorem illustrates this. In the translation to Euclidean space, we must treat separately the case where  $O$  lies on the ideal line, for then the lines  $T_1T_2$ ,  $U_1U_2$ , and  $V_1V_2$  are parallel.

The parenthetical remark following the statement of Desargue's Theorem suggests thinking of the Euclidean pictures as figures from projective geometry for a model of very large radius. That is, just as a small area of the world seems to people living there to be flat, the projective plane is locally Euclidean.

Although its local properties are familiar, the projective plane has a global property that is quite different from Euclidean space. The picture below shows a projective point. At that point we have drawn Cartesian axes,  $xy$ -axes. Of course, the axes appear in the picture at two antipodal spots, one in the northern hemisphere (that is, shown on the right, in black) and the other in the south. In the northern hemisphere a person who puts their right hand on the sphere, palm down, with their fingers pointing along the  $x$ -axis in the positive direction will have their thumb point in the positive direction on the  $y$ -axis. But the antipodal axes give the opposite: if a person puts their right hand on the southern hemisphere spot on the sphere, palm on the sphere's surface, with their fingers pointing toward positive infinity on the  $x$ -axis, then their thumb points on the  $y$ -axis toward negative infinity. Instead, to have their fingers point positively on the  $x$ -axis and their thumb point positively on the  $y$ , a person must use their left hand. Briefly, the projective plane is not orientable—in this geometry, left and right handedness are not fixed properties of figures.

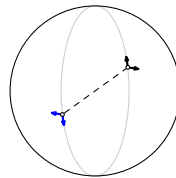

The sequence of pictures below dramatizes this non-orientability. They sketch a trip around this space in the direction of the  $y$  part of the  $xy$ -axis. (Warning: the trip shown is not halfway around, it is a full circuit. True, if we made this into a movie then we could watch the northern hemisphere spots in the drawing above gradually rotate about halfway around the sphere to the last picture below. And we could watch the southern hemisphere spots in the picture above slide through the south pole and up through the equator to the last picture. But: the spots at either end of the dashed line are the same projective point. We don't need to continue on much further; we are pretty much back to the projective point where we started by the last picture.)

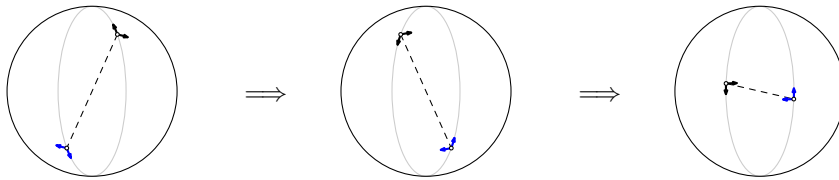

At the end of the circuit, the  $x$  part of the  $xy$ -axes sticks out in the other direction. Thus, in the projective plane we cannot describe a figure as right- or left-handed (another way to make this point is that we cannot describe a spiral as clockwise or counterclockwise).

This exhibition of the existence of a non-orientable space raises a question: is our universe orientable? For instance, could an astronaut leave earth right-handed and return left-handed? [Gardner] is a nontechnical reference. [Clarke] is a classic science fiction story about orientation reversal.

So projective geometry is mathematically interesting, in addition to the natural way in which it arises in art. It is more than just a technical device to shorten some proofs. For an overview, see [Courant & Robbins]. The approach we've taken here, the analytic approach, leads to quick theorems and—most importantly for us—illustrates the power of linear algebra (see [Hanes], [Ryan], and [Eggar]). But another approach, the synthetic approach of deriving the results from an axiom system, is both extraordinarily beautiful and is also the historical route of development. Two fine sources for this approach are [Coxeter] or [Seidenberg]. An interesting and easy application is [Davies]

**Exercises**

- 1 What is the equation of this point?

$$\begin{pmatrix} 1 \\ 0 \\ 0 \end{pmatrix}$$

- 2 (a) Find the line incident on these points in the projective plane.

$$\begin{pmatrix} 1 \\ 2 \\ 3 \end{pmatrix}, \begin{pmatrix} 4 \\ 5 \\ 6 \end{pmatrix}$$

- (b) Find the point incident on both of these projective lines.

$$(1 \ 2 \ 3), (4 \ 5 \ 6)$$

- 3 Find the formula for the line incident on two projective points. Find the formula for the point incident on two projective lines.
- 4 Prove that the definition of incidence is independent of the choice of the representatives of  $p$  and  $L$ . That is, if  $p_1, p_2, p_3$ , and  $q_1, q_2, q_3$  are two triples of homogeneous coordinates for  $p$ , and  $L_1, L_2, L_3$ , and  $M_1, M_2, M_3$  are two triples of homogeneous coordinates for  $L$ , prove that  $p_1L_1 + p_2L_2 + p_3L_3 = 0$  if and only if  $q_1M_1 + q_2M_2 + q_3M_3 = 0$ .
- 5 Give a drawing to show that central projection does not preserve circles, that a circle may project to an ellipse. Can a (non-circular) ellipse project to a circle?
- 6 Give the formula for the correspondence between the non-equatorial part of the antipodal model of the projective plane, and the plane  $z = 1$ .

- 7 (Pappus's Theorem) Assume that  $T_0$ ,  $U_0$ , and  $V_0$  are collinear and that  $T_1$ ,  $U_1$ , and  $V_1$  are collinear. Consider these three points: (i) the intersection  $V_2$  of the lines  $T_0U_1$  and  $T_1U_0$ , (ii) the intersection  $U_2$  of the lines  $T_0V_1$  and  $T_1V_0$ , and (iii) the intersection  $T_2$  of  $U_0V_1$  and  $U_1V_0$ .
- Draw a (Euclidean) picture.
  - Apply the lemma used in Desargue's Theorem to get simple homogeneous coordinate vectors for the  $T$ 's and  $V_0$ .
  - Find the resulting homogeneous coordinate vectors for  $U$ 's (these must each involve a parameter as, e.g.,  $U_0$  could be anywhere on the  $T_0V_0$  line).
  - Find the resulting homogeneous coordinate vectors for  $V_1$ . (*Hint*: it involves two parameters.)
  - Find the resulting homogeneous coordinate vectors for  $V_2$ . (It also involves two parameters.)
  - Show that the product of the three parameters is 1.
  - Verify that  $V_2$  is on the  $T_2U_2$  line.



# Similarity

We have shown that for any homomorphism there are bases  $B$  and  $D$  such that the representation matrix has a block partial-identity form.

$$\text{Rep}_{B,D}(h) = \left( \begin{array}{c|c} \text{Identity} & \text{Zero} \\ \hline \text{Zero} & \text{Zero} \end{array} \right)$$

This representation describes the map as sending  $c_1\vec{\beta}_1 + \cdots + c_n\vec{\beta}_n$  to  $c_1\vec{\delta}_1 + \cdots + c_k\vec{\delta}_k + \vec{0} + \cdots + \vec{0}$ , where  $n$  is the dimension of the domain and  $k$  is the dimension of the range. So, under this representation the action of the map is easy to understand because most of the matrix entries are zero.

This chapter considers the special case where the domain and codomain are the same. We naturally ask for the basis for the domain and codomain be the same, that is, we want a  $B$  so that  $\text{Rep}_{B,B}(t)$  is as simple as possible (we will take ‘simple’ to mean that it has many zeroes). We will find that we cannot always get a matrix having the above block partial-identity form but we will develop a form that comes close, a representation that is nearly diagonal.

## I Complex Vector Spaces

This chapter requires that we factor polynomials, but many polynomials do not factor over the real numbers. For instance,  $x^2 + 1$  does not factor into a product of two linear polynomials with real coefficients, instead it requires complex numbers  $x^2 + 1 = (x - i)(x + i)$ .

Therefore, in this chapter we shall use complex numbers for our scalars, including entries in vectors and matrices. That is, we are shifting from studying vector spaces over the real numbers to vector spaces over the complex numbers.

Any real number is a complex number and in this chapter most of the examples use only real numbers. Nonetheless, the critical theorems require that

the scalars be complex so the first section below is a quick review of complex numbers.

In this book, our approach is to shift to this more general context of taking scalars to be complex only for the pragmatic reason that we must do so now in order to move forward. However, the idea of doing vector spaces by taking scalars from a structure other than the real numbers is an interesting and useful one. Delightful presentations that take this approach from the start are in [Halmos] and [Hoffman & Kunze].

## 1.1 Factoring and Complex Numbers; A Review

*This subsection is a review only and we take the main results as known. For proofs, see [Birkhoff & MacLane] or [Ebbinghaus].*

We consider a *polynomial*  $p(x) = c_n x^n + \cdots + c_1 x + c_0$  with *leading coefficient*  $c_n \neq 0$ . The *degree* of the polynomial is  $n$  if  $n \geq 1$ . If  $n = 0$  then  $p$  is a *constant polynomial*  $p(x) = c_0$ . Constant polynomials that are not the zero polynomial,  $c_0 \neq 0$ , have degree zero. We define the zero polynomial to have degree  $-\infty$ .

Just as integers have a division operation—e.g., ‘4 goes 5 times into 21 with remainder 1’—so do polynomials.

**1.1 Theorem (Division Theorem for Polynomials)** Let  $c(x)$  be a polynomial. If  $m(x)$  is a non-zero polynomial then there are *quotient* and *remainder* polynomials  $q(x)$  and  $r(x)$  such that

$$c(x) = m(x) \cdot q(x) + r(x)$$

where the degree of  $r(x)$  is strictly less than the degree of  $m(x)$ .

**1.2 Remark** Defining the degree of the zero polynomial to be  $-\infty$ , which most but not all authors do, allows the equation  $\text{degree}(fg) = \text{degree}(f) + \text{degree}(g)$  to hold for all polynomial functions  $f$  and  $g$ .

The point of the integer division statement ‘4 goes 5 times into 21 with remainder 1’ is that the remainder is less than 4—while 4 goes 5 times, it does not go 6 times. In the same way, the point of the polynomial division statement is its final clause.

**1.3 Example** If  $c(x) = 2x^3 - 3x^2 + 4x$  and  $m(x) = x^2 + 1$  then  $q(x) = 2x - 3$  and  $r(x) = 2x + 3$ . Note that  $r(x)$  has a lower degree than  $m(x)$ .

**1.4 Corollary** The remainder when  $c(x)$  is divided by  $x - \lambda$  is the constant polynomial  $r(x) = c(\lambda)$ .

**PROOF** The remainder must be a constant polynomial because it is of degree less than the divisor  $x - \lambda$ . To determine the constant, take  $m(x)$  from the theorem to be  $x - \lambda$  and substitute  $\lambda$  for  $x$  to get  $c(\lambda) = (\lambda - \lambda) \cdot q(\lambda) + r(x)$ . QED

If a divisor  $m(x)$  goes into a dividend  $c(x)$  evenly, meaning that  $r(x)$  is the zero polynomial, then  $m(x)$  is a *factor* of  $c(x)$ . Any *root* of the factor (any  $\lambda \in \mathbb{R}$  such that  $m(\lambda) = 0$ ) is a root of  $c(x)$  since  $c(\lambda) = m(\lambda) \cdot q(\lambda) = 0$ .

**1.5 Corollary** If  $\lambda$  is a root of the polynomial  $c(x)$  then  $x - \lambda$  divides  $c(x)$  evenly, that is,  $x - \lambda$  is a factor of  $c(x)$ .

**PROOF** By the above corollary  $c(x) = (x - \lambda) \cdot q(x) + c(\lambda)$ . Since  $\lambda$  is a root,  $c(\lambda) = 0$  so  $x - \lambda$  is a factor. QED

Finding the roots and factors of a high-degree polynomial can be hard. But for second-degree polynomials we have the quadratic formula: the roots of  $ax^2 + bx + c$  are

$$\lambda_1 = \frac{-b + \sqrt{b^2 - 4ac}}{2a} \quad \lambda_2 = \frac{-b - \sqrt{b^2 - 4ac}}{2a}$$

(if the discriminant  $b^2 - 4ac$  is negative then the polynomial has no real number roots). A polynomial that cannot be factored into two lower-degree polynomials with real number coefficients is *irreducible over the reals*.

**1.6 Theorem** Any constant or linear polynomial is irreducible over the reals. A quadratic polynomial is irreducible over the reals if and only if its discriminant is negative. No cubic or higher-degree polynomial is irreducible over the reals.

**1.7 Corollary** Any polynomial with real coefficients can be factored into linear and irreducible quadratic polynomials. That factorization is unique; any two factorizations have the same powers of the same factors.

Note the analogy with the prime factorization of integers. In both cases, the uniqueness clause is very useful.

**1.8 Example** Because of uniqueness we know, without multiplying them out, that  $(x + 3)^2(x^2 + 1)^3$  does not equal  $(x + 3)^4(x^2 + x + 1)^2$ .

**1.9 Example** By uniqueness, if  $c(x) = m(x) \cdot q(x)$  then where  $c(x) = (x - 3)^2(x + 2)^3$  and  $m(x) = (x - 3)(x + 2)^2$ , we know that  $q(x) = (x - 3)(x + 2)$ .

While  $x^2 + 1$  has no real roots and so doesn't factor over the real numbers, if we imagine a root — traditionally denoted  $i$  so that  $i^2 + 1 = 0$  — then  $x^2 + 1$  factors into a product of linears  $(x - i)(x + i)$ .

So we adjoin this root  $i$  to the reals and close the new system with respect to addition, multiplication, etc. (i.e., we also add  $3 + i$ , and  $2i$ , and  $3 + 2i$ , etc., putting in all linear combinations of  $1$  and  $i$ ). We then get a new structure, the *complex numbers*  $\mathbb{C}$ .

In  $\mathbb{C}$  we can factor (obviously, at least some) quadratics that would be irreducible if we were to stick to the real numbers. Surprisingly, in  $\mathbb{C}$  we can not only factor  $x^2 + 1$  and its close relatives, we can factor any quadratic.

$$ax^2 + bx + c = a \cdot \left(x - \frac{-b + \sqrt{b^2 - 4ac}}{2a}\right) \cdot \left(x - \frac{-b - \sqrt{b^2 - 4ac}}{2a}\right)$$

**1.10 Example** The second degree polynomial  $x^2 + x + 1$  factors over the complex numbers into the product of two first degree polynomials.

$$\left(x - \frac{-1 + \sqrt{-3}}{2}\right)\left(x - \frac{-1 - \sqrt{-3}}{2}\right) = \left(x - \left(-\frac{1}{2} + \frac{\sqrt{3}}{2}i\right)\right)\left(x - \left(-\frac{1}{2} - \frac{\sqrt{3}}{2}i\right)\right)$$

**1.11 Theorem (Fundamental Theorem of Algebra)** Polynomials with complex coefficients factor into linear polynomials with complex coefficients. The factorization is unique.

## 1.2 Complex Representations

Recall the definitions of the complex number addition

$$(a + bi) + (c + di) = (a + c) + (b + d)i$$

and multiplication.

$$\begin{aligned}(a + bi)(c + di) &= ac + adi + bci + bd(-1) \\ &= (ac - bd) + (ad + bc)i\end{aligned}$$

**2.1 Example** For instance,  $(1 - 2i) + (5 + 4i) = 6 + 2i$  and  $(2 - 3i)(4 - 0.5i) = 6.5 - 13i$ .

Handling scalar operations with those rules, all of the operations that we've covered for real vector spaces carry over unchanged.

**2.2 Example** Matrix multiplication is the same, although the scalar arithmetic involves more bookkeeping.

$$\begin{aligned}&\begin{pmatrix} 1 + 1i & 2 - 0i \\ i & -2 + 3i \end{pmatrix} \begin{pmatrix} 1 + 0i & 1 - 0i \\ 3i & -i \end{pmatrix} \\ &= \begin{pmatrix} (1 + 1i) \cdot (1 + 0i) + (2 - 0i) \cdot (3i) & (1 + 1i) \cdot (1 - 0i) + (2 - 0i) \cdot (-i) \\ (i) \cdot (1 + 0i) + (-2 + 3i) \cdot (3i) & (i) \cdot (1 - 0i) + (-2 + 3i) \cdot (-i) \end{pmatrix} \\ &= \begin{pmatrix} 1 + 7i & 1 - 1i \\ -9 - 5i & 3 + 3i \end{pmatrix}\end{aligned}$$

Everything else from prior chapters that we can, we shall also carry over unchanged. For instance, we shall call this

$$\left\langle \begin{pmatrix} 1 + 0i \\ 0 + 0i \\ \vdots \\ 0 + 0i \end{pmatrix}, \dots, \begin{pmatrix} 0 + 0i \\ 0 + 0i \\ \vdots \\ 1 + 0i \end{pmatrix} \right\rangle$$

the *standard basis* for  $\mathbb{C}^n$  as a vector space over  $\mathbb{C}$  and again denote it  $\mathcal{E}_n$ .

## II Similarity

We've defined two matrices  $H$  and  $\hat{H}$  to be matrix equivalent if there are nonsingular  $P$  and  $Q$  such that  $\hat{H} = PHQ$ . We were motivated by this diagram showing both  $H$  and  $\hat{H}$  representing a map,  $h$  but with respect to different pairs of bases,  $B, D$  and  $\hat{B}, \hat{D}$ .

$$\begin{array}{ccc} V_{\text{wrt } B} & \xrightarrow[H]{} & W_{\text{wrt } D} \\ \text{id} \downarrow & & \text{id} \downarrow \\ V_{\text{wrt } \hat{B}} & \xrightarrow[\hat{H}]{} & W_{\text{wrt } \hat{D}} \end{array}$$

We now consider the special case where the codomain equals the domain and in particular we add the requirement that the codomain's basis equals the domain's basis, so we are considering representations with respect to  $B, B$  and  $D, D$ .

$$\begin{array}{ccc} V_{\text{wrt } B} & \xrightarrow[S]{} & V_{\text{wrt } B} \\ \text{id} \downarrow & & \text{id} \downarrow \\ V_{\text{wrt } D} & \xrightarrow[T]{} & V_{\text{wrt } D} \end{array}$$

In matrix terms,  $\text{Rep}_{D,D}(t) = \text{Rep}_{B,D}(\text{id}) \text{Rep}_{B,B}(t) (\text{Rep}_{B,D}(\text{id}))^{-1}$ .

### II.1 Definition and Examples

**1.1 Definition** The matrices  $T$  and  $S$  are *similar* if there is a nonsingular  $P$  such that  $T = PSP^{-1}$ .

Since nonsingular matrices are square,  $T$  and  $S$  must be square and of the same size. Exercise 12 checks that similarity is an equivalence relation.

**1.2 Example** Calculation with these two,

$$P = \begin{pmatrix} 2 & 1 \\ 1 & 1 \end{pmatrix} \quad S = \begin{pmatrix} 2 & -3 \\ 1 & -1 \end{pmatrix}$$

gives that  $S$  is similar to this matrix.

$$T = \begin{pmatrix} 0 & -1 \\ 1 & 1 \end{pmatrix}$$

**1.3 Example** The only matrix similar to the zero matrix is itself:  $PZP^{-1} = PZ = Z$ . The identity matrix has the same property:  $PIP^{-1} = PP^{-1} = I$ .

Since matrix similarity is a special case of matrix equivalence, if two matrices are similar then they are matrix equivalent. What about the converse: must any two matrix equivalent square matrices be similar? No; the prior example shows that the similarity classes are different from the matrix equivalence classes because the matrix equivalence class of the identity consists of all nonsingular matrices of that size. Thus these two are matrix equivalent but not similar.

$$T = \begin{pmatrix} 1 & 0 \\ 0 & 1 \end{pmatrix} \quad S = \begin{pmatrix} 1 & 2 \\ 0 & 3 \end{pmatrix}$$

So some matrix equivalence classes split into two or more similarity classes—similarity gives a finer partition than does equivalence. This pictures some matrix equivalence classes subdivided into similarity classes.

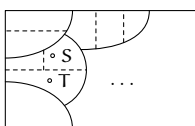

To understand the similarity relation we shall study the similarity classes. We approach this question in the same way that we've studied both the row equivalence and matrix equivalence relations, by finding a canonical form for representatives\* of the similarity classes, called Jordan form. With this canonical form, we can decide if two matrices are similar by checking whether they are in a class with the same representative. We've also seen with both row equivalence and matrix equivalence that a canonical form gives us insight into the ways in which members of the same class are alike (e.g., two identically-sized matrices are matrix equivalent if and only if they have the same rank).

### Exercises

1.4 For

$$S = \begin{pmatrix} 1 & 3 \\ -2 & -6 \end{pmatrix} \quad T = \begin{pmatrix} 0 & 0 \\ -11/2 & -5 \end{pmatrix} \quad P = \begin{pmatrix} 4 & 2 \\ -3 & 2 \end{pmatrix}$$

check that  $T = PSP^{-1}$ .

✓ 1.5 Example 1.3 shows that the only matrix similar to a zero matrix is itself and that the only matrix similar to the identity is itself.

- Show that the  $1 \times 1$  matrix  $(2)$ , also, is similar only to itself.
- Is a matrix of the form  $cI$  for some scalar  $c$  similar only to itself?
- Is a diagonal matrix similar only to itself?

✓ 1.6 Show that these matrices are not similar.

$$\begin{pmatrix} 1 & 0 & 4 \\ 1 & 1 & 3 \\ 2 & 1 & 7 \end{pmatrix} \quad \begin{pmatrix} 1 & 0 & 1 \\ 0 & 1 & 1 \\ 3 & 1 & 2 \end{pmatrix}$$

1.7 Consider the transformation  $t: \mathcal{P}_2 \rightarrow \mathcal{P}_2$  described by  $x^2 \mapsto x + 1$ ,  $x \mapsto x^2 - 1$ , and  $1 \mapsto 3$ .

- Find  $T = \text{Rep}_{B,B}(t)$  where  $B = \langle x^2, x, 1 \rangle$ .

\* More information on representatives is in the appendix.

- (b) Find  $S = \text{Rep}_{D,D}(t)$  where  $D = \langle 1, 1+x, 1+x+x^2 \rangle$ .
- (c) Find the matrix  $P$  such that  $T = PSP^{-1}$ .
- ✓ 1.8 Exhibit a nontrivial similarity relationship in this way: let  $t: \mathbb{C}^2 \rightarrow \mathbb{C}^2$  act by
- $$\begin{pmatrix} 1 \\ 2 \end{pmatrix} \mapsto \begin{pmatrix} 3 \\ 0 \end{pmatrix} \quad \begin{pmatrix} -1 \\ 1 \end{pmatrix} \mapsto \begin{pmatrix} -1 \\ 2 \end{pmatrix}$$
- and pick two bases, and represent  $t$  with respect to them  $T = \text{Rep}_{B,B}(t)$  and  $S = \text{Rep}_{D,D}(t)$ . Then compute the  $P$  and  $P^{-1}$  to change bases from  $B$  to  $D$  and back again.
- 1.9 Explain Example 1.3 in terms of maps.
- ✓ 1.10 [Halmos] Are there two matrices  $A$  and  $B$  that are similar while  $A^2$  and  $B^2$  are not similar?
- ✓ 1.11 Prove that if two matrices are similar and one is invertible then so is the other.
- ✓ 1.12 Show that similarity is an equivalence relation.
- 1.13 Consider a matrix representing, with respect to some  $B, B$ , reflection across the  $x$ -axis in  $\mathbb{R}^2$ . Consider also a matrix representing, with respect to some  $D, D$ , reflection across the  $y$ -axis. Must they be similar?
- 1.14 Prove that similarity preserves determinants and rank. Does the converse hold?
- 1.15 Is there a matrix equivalence class with only one matrix similarity class inside? One with infinitely many similarity classes?
- 1.16 Can two different diagonal matrices be in the same similarity class?
- ✓ 1.17 Prove that if two matrices are similar then their  $k$ -th powers are similar when  $k > 0$ . What if  $k \leq 0$ ?
- ✓ 1.18 Let  $p(x)$  be the polynomial  $c_n x^n + \cdots + c_1 x + c_0$ . Show that if  $T$  is similar to  $S$  then  $p(T) = c_n T^n + \cdots + c_1 T + c_0 I$  is similar to  $p(S) = c_n S^n + \cdots + c_1 S + c_0 I$ .
- 1.19 List all of the matrix equivalence classes of  $1 \times 1$  matrices. Also list the similarity classes, and describe which similarity classes are contained inside of each matrix equivalence class.
- 1.20 Does similarity preserve sums?
- 1.21 Show that if  $T - \lambda I$  and  $N$  are similar matrices then  $T$  and  $N + \lambda I$  are also similar.

## II.2 Diagonalizability

The prior subsection shows that although similar matrices are necessarily matrix equivalent, the converse does not hold. Some matrix equivalence classes break into two or more similarity classes; for instance, the nonsingular  $2 \times 2$  matrices form one matrix equivalence class but more than one similarity class.

Thus we cannot use the canonical form for matrix equivalence, a block partial-identity matrix, as a canonical form for matrix similarity. The diagram below illustrates. The stars are similarity class representatives. Each dashed-line similarity class subdivision has one star but each solid-curve matrix equivalence class division has only one partial identity matrix.



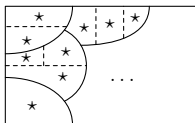

To develop a canonical form for representatives of the similarity classes we naturally build on previous work. This means first that the partial identity matrices should represent the similarity classes into which they fall. Beyond that, the representatives should be as simple as possible and the partial identities are simple in that they consist mostly of zero entries. The simplest extension of the partial identity form is the diagonal form.

**2.1 Definition** A transformation is *diagonalizable* if it has a diagonal representation with respect to the same basis for the codomain as for the domain. A *diagonalizable matrix* is one that is similar to a diagonal matrix:  $T$  is diagonalizable if there is a nonsingular  $P$  such that  $PTP^{-1}$  is diagonal.

**2.2 Example** The matrix

$$\begin{pmatrix} 4 & -2 \\ 1 & 1 \end{pmatrix}$$

is diagonalizable.

$$\begin{pmatrix} 2 & 0 \\ 0 & 3 \end{pmatrix} = \begin{pmatrix} -1 & 2 \\ 1 & -1 \end{pmatrix} \begin{pmatrix} 4 & -2 \\ 1 & 1 \end{pmatrix} \begin{pmatrix} -1 & 2 \\ 1 & -1 \end{pmatrix}^{-1}$$

**2.3 Example** This matrix is not diagonalizable

$$N = \begin{pmatrix} 0 & 0 \\ 1 & 0 \end{pmatrix}$$

because it is not the zero matrix but its square is the zero matrix. The fact that  $N$  is not the zero matrix means that it cannot be similar to the zero matrix, by Example 1.3. So if  $N$  is similar to a diagonal matrix  $D$  then  $D$  has at least one nonzero entry on its diagonal. The fact that  $N$ 's square is the zero matrix means that for any map  $n$  that  $N$  represents, the composition  $n \circ n$  is the zero map. The only matrix representing the zero map is the zero matrix and thus  $D^2$  would have to be the zero matrix. But  $D^2$  cannot be the zero matrix because the square of a diagonal matrix is the diagonal matrix whose entries are the squares of the entries from the starting matrix, and  $D$  is not the zero matrix.

That example shows that a diagonal form will not suffice as a canonical form — we cannot find a diagonal matrix in each matrix similarity class. However, the canonical form that we are developing has the property that if a matrix can be diagonalized then the diagonal matrix is the canonical representative of its similarity class.

**2.4 Corollary** A transformation  $t$  is diagonalizable if and only if there is a basis  $B = \langle \vec{\beta}_1, \dots, \vec{\beta}_n \rangle$  and scalars  $\lambda_1, \dots, \lambda_n$  such that  $t(\vec{\beta}_i) = \lambda_i \vec{\beta}_i$  for each  $i$ .

PROOF Consider a diagonal representation matrix.

$$\text{Rep}_{B,B}(t) = \begin{pmatrix} \vdots & & \vdots \\ \text{Rep}_B(t(\vec{\beta}_1)) & \cdots & \text{Rep}_B(t(\vec{\beta}_n)) \\ \vdots & & \vdots \end{pmatrix} = \begin{pmatrix} \lambda_1 & & 0 \\ \vdots & \ddots & \vdots \\ 0 & & \lambda_n \end{pmatrix}$$

Consider the representation of a member of this basis with respect to the basis  $\text{Rep}_B(\vec{\beta}_i)$ . The product of the diagonal matrix and the representation vector

$$\text{Rep}_B(t(\vec{\beta}_i)) = \begin{pmatrix} \lambda_1 & & 0 \\ \vdots & \ddots & \vdots \\ 0 & & \lambda_n \end{pmatrix} \begin{pmatrix} 0 \\ \vdots \\ 1 \\ \vdots \\ 0 \end{pmatrix} = \begin{pmatrix} 0 \\ \vdots \\ \lambda_i \\ \vdots \\ 0 \end{pmatrix}$$

has the stated action.

QED

**2.5 Example** To diagonalize

$$T = \begin{pmatrix} 3 & 2 \\ 0 & 1 \end{pmatrix}$$

we take it as the representation of a transformation with respect to the standard basis  $T = \text{Rep}_{\mathcal{E}_2, \mathcal{E}_2}(t)$  and we look for a basis  $B = \langle \vec{\beta}_1, \vec{\beta}_2 \rangle$  such that

$$\text{Rep}_{B,B}(t) = \begin{pmatrix} \lambda_1 & 0 \\ 0 & \lambda_2 \end{pmatrix}$$

that is, such that  $t(\vec{\beta}_1) = \lambda_1 \vec{\beta}_1$  and  $t(\vec{\beta}_2) = \lambda_2 \vec{\beta}_2$ .

$$\begin{pmatrix} 3 & 2 \\ 0 & 1 \end{pmatrix} \vec{\beta}_1 = \lambda_1 \cdot \vec{\beta}_1 \quad \begin{pmatrix} 3 & 2 \\ 0 & 1 \end{pmatrix} \vec{\beta}_2 = \lambda_2 \cdot \vec{\beta}_2$$

We are looking for scalars  $x$  such that this equation

$$\begin{pmatrix} 3 & 2 \\ 0 & 1 \end{pmatrix} \begin{pmatrix} b_1 \\ b_2 \end{pmatrix} = x \cdot \begin{pmatrix} b_1 \\ b_2 \end{pmatrix}$$

has solutions  $b_1$  and  $b_2$ , which are not both zero (the zero vector is not the member of any basis). That's a linear system.

$$\begin{aligned} (3-x) \cdot b_1 + 2 \cdot b_2 &= 0 \\ (1-x) \cdot b_2 &= 0 \end{aligned} \quad (*)$$

Focus first on the bottom equation. The two numbers multiply to give zero only if at least one of them is zero so there are two cases,  $b_2 = 0$  or  $x = 1$ . In the

$b_2 = 0$  case, the first equation gives that either  $b_1 = 0$  or  $x = 3$ . Since we've disallowed the case of both  $b_1 = 0$  and  $b_2 = 0$ , we are left with  $\lambda_1 = 3$ . Then the first equation in (\*) is  $0 \cdot b_1 + 2 \cdot b_2 = 0$  and so associated with  $\lambda_1 = 3$  are vectors with a second component of zero and a first component that is free.

$$\begin{pmatrix} 3 & 2 \\ 0 & 1 \end{pmatrix} \begin{pmatrix} b_1 \\ 0 \end{pmatrix} = 3 \cdot \begin{pmatrix} b_1 \\ 0 \end{pmatrix}$$

Choose any nonzero  $b_1$  to have a first basis vector.

$$\vec{\beta}_1 = \begin{pmatrix} 1 \\ 0 \end{pmatrix}$$

The second case for the bottom equation of (\*) is  $\lambda_2 = 1$ . The first equation in (\*) is then  $2 \cdot b_1 + 2 \cdot b_2 = 0$  and so associated with 1 are vectors such that their second component is the negative of their first.

$$\begin{pmatrix} 3 & 2 \\ 0 & 1 \end{pmatrix} \begin{pmatrix} b_1 \\ -b_1 \end{pmatrix} = 1 \cdot \begin{pmatrix} b_1 \\ -b_1 \end{pmatrix}$$

Choose a nonzero one of these to have a second basis vector.

$$\vec{\beta}_2 = \begin{pmatrix} 1 \\ -1 \end{pmatrix}$$

Now drawing the similarity diagram

$$\begin{array}{ccc} \mathbb{R}_{\text{wrt } \mathcal{E}_2}^2 & \xrightarrow[\mathbf{T}]{\mathbf{t}} & \mathbb{R}_{\text{wrt } \mathcal{E}_2}^2 \\ \text{id} \downarrow & & \text{id} \downarrow \\ \mathbb{R}_{\text{wrt } \mathbf{B}}^2 & \xrightarrow[\mathbf{D}]{\mathbf{t}} & \mathbb{R}_{\text{wrt } \mathbf{B}}^2 \end{array}$$

and noting that the matrix  $\text{Rep}_{\mathbf{B}, \mathcal{E}_2}(\text{id})$  is easy gives us this diagonalization.

$$\begin{pmatrix} 3 & 0 \\ 0 & 1 \end{pmatrix} = \begin{pmatrix} 1 & 1 \\ 0 & -1 \end{pmatrix}^{-1} \begin{pmatrix} 3 & 2 \\ 0 & 1 \end{pmatrix} \begin{pmatrix} 1 & 1 \\ 0 & -1 \end{pmatrix}$$

In the next subsection, we will expand on that example by considering more closely the property of Corollary 2.4. This includes seeing another way, the way that we will routinely use, to find the  $\lambda$ 's.

### Exercises

✓ 2.6 Repeat Example 2.5 for the matrix from Example 2.2.

2.7 Diagonalize these upper triangular matrices.

$$(a) \begin{pmatrix} -2 & 1 \\ 0 & 2 \end{pmatrix} \quad (b) \begin{pmatrix} 5 & 4 \\ 0 & 1 \end{pmatrix}$$

- ✓ 2.8 What form do the powers of a diagonal matrix have?
- 2.9 Give two same-sized diagonal matrices that are not similar. Must any two different diagonal matrices come from different similarity classes?
- 2.10 Give a nonsingular diagonal matrix. Can a diagonal matrix ever be singular?
- ✓ 2.11 Show that the inverse of a diagonal matrix is the diagonal of the the inverses, if no element on that diagonal is zero. What happens when a diagonal entry is zero?
- 2.12 The equation ending Example 2.5

$$\begin{pmatrix} 1 & 1 \\ 0 & -1 \end{pmatrix}^{-1} \begin{pmatrix} 3 & 2 \\ 0 & 1 \end{pmatrix} \begin{pmatrix} 1 & 1 \\ 0 & -1 \end{pmatrix} = \begin{pmatrix} 3 & 0 \\ 0 & 1 \end{pmatrix}$$

is a bit jarring because for  $P$  we must take the first matrix, which is shown as an inverse, and for  $P^{-1}$  we take the inverse of the first matrix, so that the two  $-1$  powers cancel and this matrix is shown without a superscript  $-1$ .

(a) Check that this nicer-appearing equation holds.

$$\begin{pmatrix} 3 & 0 \\ 0 & 1 \end{pmatrix} = \begin{pmatrix} 1 & 1 \\ 0 & -1 \end{pmatrix} \begin{pmatrix} 3 & 2 \\ 0 & 1 \end{pmatrix} \begin{pmatrix} 1 & 1 \\ 0 & -1 \end{pmatrix}^{-1}$$

(b) Is the previous item a coincidence? Or can we always switch the  $P$  and the  $P^{-1}$ ?

- 2.13 Show that the  $P$  used to diagonalize in Example 2.5 is not unique.
- 2.14 Find a formula for the powers of this matrix *Hint*: see Exercise 8.

$$\begin{pmatrix} -3 & 1 \\ -4 & 2 \end{pmatrix}$$

- ✓ 2.15 Diagonalize these.

$$(a) \begin{pmatrix} 1 & 1 \\ 0 & 0 \end{pmatrix} \quad (b) \begin{pmatrix} 0 & 1 \\ 1 & 0 \end{pmatrix}$$

2.16 We can ask how diagonalization interacts with the matrix operations. Assume that  $t, s: V \rightarrow V$  are each diagonalizable. Is  $ct$  diagonalizable for all scalars  $c$ ? What about  $t + s$ ?  $t \circ s$ ?

- ✓ 2.17 Show that matrices of this form are not diagonalizable.

$$\begin{pmatrix} 1 & c \\ 0 & 1 \end{pmatrix} \quad c \neq 0$$

2.18 Show that each of these is diagonalizable.

$$(a) \begin{pmatrix} 1 & 2 \\ 2 & 1 \end{pmatrix} \quad (b) \begin{pmatrix} x & y \\ y & z \end{pmatrix} \quad x, y, z \text{ scalars}$$

## II.3 Eigenvalues and Eigenvectors

In this subsection we will focus on the property of Corollary 2.4.

**3.1 Definition** A transformation  $t: V \rightarrow V$  has a scalar *eigenvalue*  $\lambda$  if there is a nonzero *eigenvector*  $\vec{z} \in V$  such that  $t(\vec{z}) = \lambda \cdot \vec{z}$ .

(“Eigen” is German for “characteristic of” or “peculiar to.” Some authors call these *characteristic* values and vectors. No one calls them “peculiar.”)

**3.2 Remark** This definition requires that the eigenvector be non- $\vec{0}$ . Some authors allow  $\vec{0}$  as an eigenvector for  $\lambda$  as long as there are also non- $\vec{0}$  vectors associated with  $\lambda$ . Neither style of definition is clearly better; both involve small tradeoffs. In both styles the key point is to not allow a case where  $\lambda$  is such that  $t(\vec{v}) = \lambda\vec{v}$  for only the single vector  $\vec{v} = \vec{0}$ .

Also, note that  $\lambda$  could be 0. The issue is whether  $\vec{\zeta}$  could be  $\vec{0}$ .

**3.3 Example** The projection map

$$\begin{pmatrix} x \\ y \\ z \end{pmatrix} \mapsto \begin{pmatrix} x \\ y \\ 0 \end{pmatrix} \quad x, y, z \in \mathbb{C}$$

has an eigenvalue of 1 associated with any eigenvector of the form

$$\begin{pmatrix} x \\ y \\ 0 \end{pmatrix}$$

where  $x$  and  $y$  are scalars that are not both zero. On the other hand, 2 is not an eigenvalue of  $\pi$  since no non- $\vec{0}$  vector is doubled.

**3.4 Example** The only transformation on the trivial space  $\{\vec{0}\}$  is  $\vec{0} \mapsto \vec{0}$ . This map has no eigenvalues because there are no non- $\vec{0}$  vectors  $\vec{v}$  mapped to a scalar multiple  $\lambda \cdot \vec{v}$  of themselves.

**3.5 Example** Consider the homomorphism  $t: \mathcal{P}_1 \rightarrow \mathcal{P}_1$  given by  $c_0 + c_1x \mapsto (c_0 + c_1) + (c_0 + c_1)x$ . While the codomain  $\mathcal{P}_1$  of  $t$  is two-dimensional, its range is one-dimensional  $\mathcal{R}(t) = \{c + cx \mid c \in \mathbb{C}\}$ . Application of  $t$  to a vector in that range will simply rescale the vector  $c + cx \mapsto (2c) + (2c)x$ . That is,  $t$  has an eigenvalue of 2 associated with eigenvectors of the form  $c + cx$  where  $c \neq 0$ .

This map also has an eigenvalue of 0 associated with eigenvectors of the form  $c - cx$  where  $c \neq 0$ .

**3.6 Definition** A square matrix  $T$  has a scalar *eigenvalue*  $\lambda$  associated with the nonzero *eigenvector*  $\vec{\zeta}$  if  $T\vec{\zeta} = \lambda \cdot \vec{\zeta}$ .

Although this extension from maps to matrices is natural, we need to make one observation. Eigenvalues of a map are also the eigenvalues of matrices representing that map and so similar matrices have the same eigenvalues. But the eigenvectors can differ — similar matrices need not have the same eigenvectors.

**3.7 Example** Consider again the transformation  $t: \mathcal{P}_1 \rightarrow \mathcal{P}_1$  from Example 3.5 given by  $c_0 + c_1x \mapsto (c_0 + c_1) + (c_0 + c_1)x$ . One of its eigenvalues is 2, associated with the eigenvectors  $c + cx$  where  $c \neq 0$ . If we represent  $t$  with respect to  $B = \langle 1 + 1x, 1 - 1x \rangle$

$$T = \text{Rep}_{B,B}(t) = \begin{pmatrix} 2 & 0 \\ 0 & 0 \end{pmatrix}$$

then 2 is an eigenvalue of the matrix  $T$ , associated with these eigenvectors.

$$\left\{ \begin{pmatrix} c_0 \\ c_1 \end{pmatrix} \mid \begin{pmatrix} 2 & 0 \\ 0 & 0 \end{pmatrix} \begin{pmatrix} c_0 \\ c_1 \end{pmatrix} = \begin{pmatrix} 2c_0 \\ 2c_1 \end{pmatrix} \right\} = \left\{ \begin{pmatrix} c_0 \\ 0 \end{pmatrix} \mid c_0 \in \mathbb{C}, c_0 \neq 0 \right\}$$

On the other hand, if we represent  $t$  with respect to  $D = \langle 2 + 1x, 1 + 0x \rangle$

$$S = \text{Rep}_{D,D}(t) = \begin{pmatrix} 3 & 1 \\ -3 & -1 \end{pmatrix}$$

then the eigenvectors associated with the eigenvalue 2 are these.

$$\left\{ \begin{pmatrix} c_0 \\ c_1 \end{pmatrix} \mid \begin{pmatrix} 3 & 1 \\ -3 & -1 \end{pmatrix} \begin{pmatrix} c_0 \\ c_1 \end{pmatrix} = \begin{pmatrix} 2c_0 \\ 2c_1 \end{pmatrix} \right\} = \left\{ \begin{pmatrix} 0 \\ c_1 \end{pmatrix} \mid c_1 \in \mathbb{C}, c_1 \neq 0 \right\}$$

**3.8 Remark** Here is an informal description of the reason for the difference. The underlying transformation doubles the eigenvectors  $\vec{v} \mapsto 2 \cdot \vec{v}$ . But when the matrix representing the transformation is  $T = \text{Rep}_{B,B}(t)$  then the matrix “assumes” that column vectors are representations with respect to  $B$ . In contrast,  $S = \text{Rep}_{D,D}(t)$  “assumes” that column vectors are representations with respect to  $D$ . So the column vector representations that get doubled by each matrix are different.

The next example shows the basic tool for finding eigenvectors and eigenvalues.

**3.9 Example** If

$$T = \begin{pmatrix} 1 & 2 & 1 \\ 2 & 0 & -2 \\ -1 & 2 & 3 \end{pmatrix}$$

then to find the scalars  $\lambda$  such that  $T\vec{z} = \lambda\vec{z}$  for nonzero eigenvectors  $\vec{z}$ , bring everything to the left-hand side

$$\begin{pmatrix} 1 & 2 & 1 \\ 2 & 0 & -2 \\ -1 & 2 & 3 \end{pmatrix} \begin{pmatrix} z_1 \\ z_2 \\ z_3 \end{pmatrix} - \lambda \begin{pmatrix} z_1 \\ z_2 \\ z_3 \end{pmatrix} = \vec{0}$$

and factor  $(T - \lambda I)\vec{z} = \vec{0}$ . (Note that it says  $T - \lambda I$ . The expression  $T - \lambda$  doesn't make sense because  $T$  is a matrix while  $\lambda$  is a scalar.) This homogeneous linear system

$$\begin{pmatrix} 1-\lambda & 2 & 1 \\ 2 & 0-\lambda & -2 \\ -1 & 2 & 3-\lambda \end{pmatrix} \begin{pmatrix} z_1 \\ z_2 \\ z_3 \end{pmatrix} = \begin{pmatrix} 0 \\ 0 \\ 0 \end{pmatrix}$$

has a nonzero solution  $\vec{z}$  if and only if the matrix is singular. We can determine

when that happens.

$$\begin{aligned}
 0 &= |T - xI| \\
 &= \begin{vmatrix} 1-x & 2 & 1 \\ 2 & 0-x & -2 \\ -1 & 2 & 3-x \end{vmatrix} \\
 &= x^3 - 4x^2 + 4x \\
 &= x(x-2)^2
 \end{aligned}$$

The eigenvalues are  $\lambda_1 = 0$  and  $\lambda_2 = 2$ . To find the associated eigenvectors plug in each eigenvalue. Plugging in  $\lambda_1 = 0$  gives

$$\begin{pmatrix} 1-0 & 2 & 1 \\ 2 & 0-0 & -2 \\ -1 & 2 & 3-0 \end{pmatrix} \begin{pmatrix} z_1 \\ z_2 \\ z_3 \end{pmatrix} = \begin{pmatrix} 0 \\ 0 \\ 0 \end{pmatrix} \implies \begin{pmatrix} z_1 \\ z_2 \\ z_3 \end{pmatrix} = \begin{pmatrix} a \\ -a \\ a \end{pmatrix}$$

for  $a \neq 0$  ( $a$  is non-0 because eigenvectors must be non- $\vec{0}$ ). Plugging in  $\lambda_2 = 2$  gives

$$\begin{pmatrix} 1-2 & 2 & 1 \\ 2 & 0-2 & -2 \\ -1 & 2 & 3-2 \end{pmatrix} \begin{pmatrix} z_1 \\ z_2 \\ z_3 \end{pmatrix} = \begin{pmatrix} 0 \\ 0 \\ 0 \end{pmatrix} \implies \begin{pmatrix} z_1 \\ z_2 \\ z_3 \end{pmatrix} = \begin{pmatrix} b \\ 0 \\ b \end{pmatrix}$$

with  $b \neq 0$ .

**3.10 Example** If

$$S = \begin{pmatrix} \pi & 1 \\ 0 & 3 \end{pmatrix}$$

(here  $\pi$  is not a projection map, it is the number 3.14...) then

$$\begin{vmatrix} \pi-x & 1 \\ 0 & 3-x \end{vmatrix} = (x-\pi)(x-3)$$

so  $S$  has eigenvalues of  $\lambda_1 = \pi$  and  $\lambda_2 = 3$ . To find associated eigenvectors, first plug in  $\lambda_1$  for  $x$

$$\begin{pmatrix} \pi-\pi & 1 \\ 0 & 3-\pi \end{pmatrix} \begin{pmatrix} z_1 \\ z_2 \end{pmatrix} = \begin{pmatrix} 0 \\ 0 \end{pmatrix} \implies \begin{pmatrix} z_1 \\ z_2 \end{pmatrix} = \begin{pmatrix} a \\ 0 \end{pmatrix}$$

for a scalar  $a \neq 0$ . Then plug in  $\lambda_2$

$$\begin{pmatrix} \pi-3 & 1 \\ 0 & 3-3 \end{pmatrix} \begin{pmatrix} z_1 \\ z_2 \end{pmatrix} = \begin{pmatrix} 0 \\ 0 \end{pmatrix} \implies \begin{pmatrix} z_1 \\ z_2 \end{pmatrix} = \begin{pmatrix} -b/(\pi-3) \\ b \end{pmatrix}$$

where  $b \neq 0$ .

**3.11 Definition** The *characteristic polynomial* of a square matrix  $T$  is the determinant  $|T - xI|$  where  $x$  is a variable. The *characteristic equation* is  $|T - xI| = 0$ . The *characteristic polynomial* of a transformation  $t$  is the characteristic polynomial of any matrix representation  $\text{Rep}_{B,B}(t)$ .

Exercise 32 checks that the characteristic polynomial of a transformation is well-defined, that is, that the characteristic polynomial is the same no matter which basis  $B$  we use for the representation.

**3.12 Lemma** A linear transformation on a nontrivial vector space has at least one eigenvalue.

PROOF Any root of the characteristic polynomial is an eigenvalue. Over the complex numbers, any polynomial of degree one or greater has a root. QED

**3.13 Remark** This result is the reason that in this chapter we've changed to using scalars that are complex.

**3.14 Definition** The *eigenspace* of a transformation  $t$  associated with the eigenvalue  $\lambda$  is  $V_\lambda = \{ \vec{z} \mid t(\vec{z}) = \lambda \vec{z} \}$ . The eigenspace of a matrix is analogous.

**3.15 Lemma** An eigenspace is a subspace.

PROOF An eigenspace is nonempty because it contains the zero vector since for any linear transformation  $t(\vec{0}) = \vec{0}$ , which equals  $\lambda \vec{0}$ . Thus we need only check closure of linear combinations. Take  $\vec{z}_1, \dots, \vec{z}_n \in V_\lambda$  and verify

$$\begin{aligned} t(c_1 \vec{z}_1 + c_2 \vec{z}_2 + \dots + c_n \vec{z}_n) &= c_1 t(\vec{z}_1) + \dots + c_n t(\vec{z}_n) \\ &= c_1 \lambda \vec{z}_1 + \dots + c_n \lambda \vec{z}_n \\ &= \lambda(c_1 \vec{z}_1 + \dots + c_n \vec{z}_n) \end{aligned}$$

that the combination is also in  $V_\lambda$  (despite that the zero vector isn't an eigenvector, the second equality holds even if some  $\vec{z}_i$  is  $\vec{0}$  since  $t(\vec{0}) = \lambda \cdot \vec{0} = \vec{0}$ ). QED

**3.16 Example** In Example 3.10 the eigenspace associated with the eigenvalue  $\pi$  and the eigenspace associated with the eigenvalue 3 are these.

$$V_\pi = \left\{ \begin{pmatrix} a \\ 0 \end{pmatrix} \mid a \in \mathbb{C} \right\} \quad V_3 = \left\{ \begin{pmatrix} -b/(\pi-3) \\ b \end{pmatrix} \mid b \in \mathbb{C} \right\}$$

**3.17 Example** In Example 3.9 these are the eigenspaces associated with the eigenvalues 0 and 2.

$$V_0 = \left\{ \begin{pmatrix} a \\ -a \\ a \end{pmatrix} \mid a \in \mathbb{C} \right\}, \quad V_2 = \left\{ \begin{pmatrix} b \\ 0 \\ b \end{pmatrix} \mid b \in \mathbb{C} \right\}.$$



The characteristic equation in Example 3.9 is  $0 = x(x - 2)^2$  so in some sense 2 is an eigenvalue twice. However there are not twice as many eigenvectors in that the dimension of the associated eigenspace  $V_2$  is one, not two. The next example is a case where a number is a double root of the characteristic equation and the dimension of the associated eigenspace is two.

**3.18 Example** With respect to the standard bases, this matrix

$$\begin{pmatrix} 1 & 0 & 0 \\ 0 & 1 & 0 \\ 0 & 0 & 0 \end{pmatrix}$$

represents projection.

$$\begin{pmatrix} x \\ y \\ z \end{pmatrix} \xrightarrow{\pi} \begin{pmatrix} x \\ y \\ 0 \end{pmatrix} \quad x, y, z \in \mathbb{C}$$

Its eigenspace associated with the eigenvalue 0 and its eigenspace associated with the eigenvalue 1 are easy to find.

$$V_0 = \left\{ \begin{pmatrix} 0 \\ 0 \\ c_3 \end{pmatrix} \mid c_3 \in \mathbb{C} \right\} \quad V_1 = \left\{ \begin{pmatrix} c_1 \\ c_2 \\ 0 \end{pmatrix} \mid c_1, c_2 \in \mathbb{C} \right\}$$

By Lemma 3.15 if two eigenvectors  $\vec{v}_1$  and  $\vec{v}_2$  are associated with the same eigenvalue then a linear combination of those two is also an eigenvector, associated with the same eigenvalue. Thus, referring to the prior example, this sum of two members of  $V_1$

$$\begin{pmatrix} 1 \\ 0 \\ 0 \end{pmatrix} + \begin{pmatrix} 0 \\ 1 \\ 0 \end{pmatrix}$$

yields another member of  $V_1$ .

The next result speaks to the situation where the vectors come from different eigenspaces.

**3.19 Theorem** For any set of distinct eigenvalues of a map or matrix, a set of associated eigenvectors, one per eigenvalue, is linearly independent.

**PROOF** We will use induction on the number of eigenvalues. If there is no eigenvalue then the set of associated vectors is empty, and is linearly independent. If there is only one eigenvalue then the set of associated eigenvectors is a singleton set with a non- $\vec{0}$  member, and so is linearly independent.

For induction assume that the theorem is true for any set of  $k$  distinct eigenvalues. Consider distinct eigenvalues  $\lambda_1, \dots, \lambda_{k+1}$  and let  $\vec{v}_1, \dots, \vec{v}_{k+1}$  be associated eigenvectors. Suppose that  $\vec{0} = c_1\vec{v}_1 + \dots + c_k\vec{v}_k + c_{k+1}\vec{v}_{k+1}$ . Derive two equations from that, the first by multiplying  $\lambda_{k+1}$  on both sides

$\vec{0} = c_1\lambda_{k+1}\vec{v}_1 + \cdots + c_{k+1}\lambda_{k+1}\vec{v}_{k+1}$  and the second by applying the map to both sides  $\vec{0} = c_1t(\vec{v}_1) + \cdots + c_{k+1}t(\vec{v}_{k+1}) = c_1\lambda_1\vec{v}_1 + \cdots + c_{k+1}\lambda_{k+1}\vec{v}_{k+1}$  (applying the matrix gives the same result). Subtract the second equation from the first

$$\vec{0} = c_1(\lambda_{k+1} - \lambda_1)\vec{v}_1 + \cdots + c_k(\lambda_{k+1} - \lambda_k)\vec{v}_k + c_{k+1}(\lambda_{k+1} - \lambda_{k+1})\vec{v}_{k+1}$$

so that the  $\vec{v}_{k+1}$  term vanishes. Then the induction hypothesis gives that  $c_1(\lambda_{k+1} - \lambda_1) = 0, \dots, c_k(\lambda_{k+1} - \lambda_k) = 0$ . All of the eigenvalues are distinct so  $c_1, \dots, c_k$  are all 0. With that,  $c_{k+1}$  must be 0 because we are left with the equation  $\vec{0} = c_{k+1}\vec{v}_{k+1}$ . QED

**3.20 Example** The eigenvalues of

$$\begin{pmatrix} 2 & -2 & 2 \\ 0 & 1 & 1 \\ -4 & 8 & 3 \end{pmatrix}$$

are distinct:  $\lambda_1 = 1, \lambda_2 = 2,$  and  $\lambda_3 = 3$ . A set of associated eigenvectors

$$\left\{ \begin{pmatrix} 2 \\ 1 \\ 0 \end{pmatrix}, \begin{pmatrix} 9 \\ 4 \\ 4 \end{pmatrix}, \begin{pmatrix} 2 \\ 1 \\ 2 \end{pmatrix} \right\}$$

is linearly independent.

**3.21 Corollary** An  $n \times n$  matrix with  $n$  distinct eigenvalues is diagonalizable.

PROOF Form a basis of eigenvectors. Apply Corollary 2.4.

QED

### Exercises

**3.22** For each, find the characteristic polynomial and the eigenvalues.

(a)  $\begin{pmatrix} 10 & -9 \\ 4 & -2 \end{pmatrix}$     (b)  $\begin{pmatrix} 1 & 2 \\ 4 & 3 \end{pmatrix}$     (c)  $\begin{pmatrix} 0 & 3 \\ 7 & 0 \end{pmatrix}$     (d)  $\begin{pmatrix} 0 & 0 \\ 0 & 0 \end{pmatrix}$   
 (e)  $\begin{pmatrix} 1 & 0 \\ 0 & 1 \end{pmatrix}$

✓ **3.23** For each matrix, find the characteristic equation, and the eigenvalues and associated eigenvectors.

(a)  $\begin{pmatrix} 3 & 0 \\ 8 & -1 \end{pmatrix}$     (b)  $\begin{pmatrix} 3 & 2 \\ -1 & 0 \end{pmatrix}$

**3.24** Find the characteristic equation, and the eigenvalues and associated eigenvectors for this matrix. *Hint.* The eigenvalues are complex.

$$\begin{pmatrix} -2 & -1 \\ 5 & 2 \end{pmatrix}$$

**3.25** Find the characteristic polynomial, the eigenvalues, and the associated eigenvectors of this matrix.

$$\begin{pmatrix} 1 & 1 & 1 \\ 0 & 0 & 1 \\ 0 & 0 & 1 \end{pmatrix}$$

✓ **3.26** For each matrix, find the characteristic equation, and the eigenvalues and associated eigenvectors.

$$(a) \begin{pmatrix} 3 & -2 & 0 \\ -2 & 3 & 0 \\ 0 & 0 & 5 \end{pmatrix} \quad (b) \begin{pmatrix} 0 & 1 & 0 \\ 0 & 0 & 1 \\ 4 & -17 & 8 \end{pmatrix}$$

✓ 3.27 Let  $t: \mathcal{P}_2 \rightarrow \mathcal{P}_2$  be

$$a_0 + a_1x + a_2x^2 \mapsto (5a_0 + 6a_1 + 2a_2) - (a_1 + 8a_2)x + (a_0 - 2a_2)x^2.$$

Find its eigenvalues and the associated eigenvectors.

3.28 Find the eigenvalues and eigenvectors of this map  $t: \mathcal{M}_2 \rightarrow \mathcal{M}_2$ .

$$\begin{pmatrix} a & b \\ c & d \end{pmatrix} \mapsto \begin{pmatrix} 2c & a+c \\ b-2c & d \end{pmatrix}$$

✓ 3.29 Find the eigenvalues and associated eigenvectors of the differentiation operator  $d/dx: \mathcal{P}_3 \rightarrow \mathcal{P}_3$ .

3.30 Prove that the eigenvalues of a triangular matrix (upper or lower triangular) are the entries on the diagonal.

✓ 3.31 Find the formula for the characteristic polynomial of a  $2 \times 2$  matrix.

3.32 Prove that the characteristic polynomial of a transformation is well-defined.

3.33 Prove or disprove: if all the eigenvalues of a matrix are 0 then it must be the zero matrix.

✓ 3.34 (a) Show that any non- $\vec{0}$  vector in any nontrivial vector space can be a eigenvector. That is, given a  $\vec{v} \neq \vec{0}$  from a nontrivial  $V$ , show that there is a transformation  $t: V \rightarrow V$  having a scalar eigenvalue  $\lambda \in \mathbb{R}$  such that  $\vec{v} \in V_\lambda$ .

(b) What if we are given a scalar  $\lambda$ ? Can any non- $\vec{0}$  member of any nontrivial vector space be an eigenvector associated with  $\lambda$ ?

✓ 3.35 Suppose that  $t: V \rightarrow V$  and  $T = \text{Rep}_{B,B}(t)$ . Prove that the eigenvectors of  $T$  associated with  $\lambda$  are the non- $\vec{0}$  vectors in the kernel of the map represented (with respect to the same bases) by  $T - \lambda I$ .

3.36 Prove that if  $a, \dots, d$  are all integers and  $a + b = c + d$  then

$$\begin{pmatrix} a & b \\ c & d \end{pmatrix}$$

has integral eigenvalues, namely  $a + b$  and  $a - c$ .

✓ 3.37 Prove that if  $T$  is nonsingular and has eigenvalues  $\lambda_1, \dots, \lambda_n$  then  $T^{-1}$  has eigenvalues  $1/\lambda_1, \dots, 1/\lambda_n$ . Is the converse true?

✓ 3.38 Suppose that  $T$  is  $n \times n$  and  $c, d$  are scalars.

(a) Prove that if  $T$  has the eigenvalue  $\lambda$  with an associated eigenvector  $\vec{v}$  then  $\vec{v}$  is an eigenvector of  $cT + dI$  associated with eigenvalue  $c\lambda + d$ .

(b) Prove that if  $T$  is diagonalizable then so is  $cT + dI$ .

✓ 3.39 Show that  $\lambda$  is an eigenvalue of  $T$  if and only if the map represented by  $T - \lambda I$  is not an isomorphism.

3.40 [Strang 80]

(a) Show that if  $\lambda$  is an eigenvalue of  $A$  then  $\lambda^k$  is an eigenvalue of  $A^k$ .

(b) What is wrong with this proof generalizing that? "If  $\lambda$  is an eigenvalue of  $A$  and  $\mu$  is an eigenvalue for  $B$ , then  $\lambda\mu$  is an eigenvalue for  $AB$ , for, if  $A\vec{x} = \lambda\vec{x}$  and  $B\vec{x} = \mu\vec{x}$  then  $AB\vec{x} = A\mu\vec{x} = \mu A\vec{x} = \mu\lambda\vec{x}$ ?"

3.41 Do matrix equivalent matrices have the same eigenvalues?

3.42 Show that a square matrix with real entries and an odd number of rows has at least one real eigenvalue.

3.43 Diagonalize.

$$\begin{pmatrix} -1 & 2 & 2 \\ 2 & 2 & 2 \\ -3 & -6 & -6 \end{pmatrix}$$

3.44 Suppose that  $P$  is a nonsingular  $n \times n$  matrix. Show that the *similarity transformation* map  $t_P: \mathcal{M}_{n \times n} \rightarrow \mathcal{M}_{n \times n}$  sending  $T \mapsto PTP^{-1}$  is an isomorphism.

? 3.45 [Math. Mag., Nov. 1967] Show that if  $A$  is an  $n$  square matrix and each row (column) sums to  $c$  then  $c$  is a characteristic root of  $A$ . (“Characteristic root” is a synonym for eigenvalue.)

### III Nilpotence

The goal of this chapter is to show that every square matrix is similar to one that is a sum of two kinds of simple matrices. The prior section focused on the first simple kind, diagonal matrices. We now consider the other.

#### III.1 Self-Composition

Because a linear transformation  $t: V \rightarrow V$  has the same domain as codomain, we can find the composition of  $t$  with itself  $t^2 = t \circ t$ , and  $t^3 = t \circ t \circ t$ , etc.\*

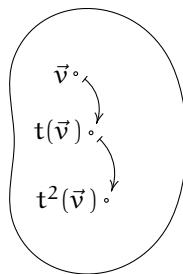

Note that the superscript power notation  $t^j$  for iterates of the transformations dovetails with the notation that we've used for their square matrix representations because if  $\text{Rep}_{B,B}(t) = T$  then  $\text{Rep}_{B,B}(t^j) = T^j$ .

**1.1 Example** For the derivative map  $d/dx: \mathcal{P}_3 \rightarrow \mathcal{P}_3$  given by

$$a + bx + cx^2 + dx^3 \xrightarrow{d/dx} b + 2cx + 3dx^2$$

the second power is the second derivative

$$a + bx + cx^2 + dx^3 \xrightarrow{d^2/dx^2} 2c + 6dx$$

the third power is the third derivative

$$a + bx + cx^2 + dx^3 \xrightarrow{d^3/dx^3} 6d$$

and any higher power is the zero map.

**1.2 Example** This transformation of the space of  $2 \times 2$  matrices

$$\begin{pmatrix} a & b \\ c & d \end{pmatrix} \xrightarrow{t} \begin{pmatrix} b & a \\ d & 0 \end{pmatrix}$$

has this second power

$$\begin{pmatrix} a & b \\ c & d \end{pmatrix} \xrightarrow{t^2} \begin{pmatrix} a & b \\ 0 & 0 \end{pmatrix}$$

\* More information on function iteration is in the appendix.

and this third power.

$$\begin{pmatrix} a & b \\ c & d \end{pmatrix} \xrightarrow{t^3} \begin{pmatrix} b & a \\ 0 & 0 \end{pmatrix}$$

After that,  $t^4 = t^2$  and  $t^5 = t^3$ , etc.

**1.3 Example** Consider the shift transformation  $t: \mathbb{C}^3 \rightarrow \mathbb{C}^3$ .

$$\begin{pmatrix} x \\ y \\ z \end{pmatrix} \xrightarrow{t} \begin{pmatrix} 0 \\ x \\ y \end{pmatrix}$$

We have that

$$\begin{pmatrix} x \\ y \\ z \end{pmatrix} \xrightarrow{t} \begin{pmatrix} 0 \\ x \\ y \end{pmatrix} \xrightarrow{t} \begin{pmatrix} 0 \\ 0 \\ x \end{pmatrix} \xrightarrow{t} \begin{pmatrix} 0 \\ 0 \\ 0 \end{pmatrix}$$

so the rangespaces descend to the trivial subspace.

$$\mathcal{R}(t) = \left\{ \begin{pmatrix} 0 \\ a \\ b \end{pmatrix} \mid a, b \in \mathbb{C} \right\} \quad \mathcal{R}(t^2) = \left\{ \begin{pmatrix} 0 \\ 0 \\ c \end{pmatrix} \mid c \in \mathbb{C} \right\} \quad \mathcal{R}(t^3) = \left\{ \begin{pmatrix} 0 \\ 0 \\ 0 \end{pmatrix} \right\}$$

These examples suggest that after some number of iterations the map settles down.

**1.4 Lemma** For any transformation  $t: V \rightarrow V$ , the rangespaces of the powers form a descending chain

$$V \supseteq \mathcal{R}(t) \supseteq \mathcal{R}(t^2) \supseteq \dots$$

and the nullspaces form an ascending chain.

$$\{\vec{0}\} \subseteq \mathcal{N}(t) \subseteq \mathcal{N}(t^2) \subseteq \dots$$

Further, there is a  $k$  such that for powers less than  $k$  the subsets are proper so that if  $j < k$  then  $\mathcal{R}(t^j) \supset \mathcal{R}(t^{j+1})$  and  $\mathcal{N}(t^j) \subset \mathcal{N}(t^{j+1})$  while for higher powers the sets are equal, that is, if  $j \geq k$  then  $\mathcal{R}(t^j) = \mathcal{R}(t^{j+1})$  and  $\mathcal{N}(t^j) = \mathcal{N}(t^{j+1})$ .

**PROOF** First recall that for any map the dimension of its rangespace plus the dimension of its nullspace equals the dimension of its domain. So if the dimensions of the rangespaces shrink then the dimensions of the nullspaces must grow. We will do the rangespace half here and leave the rest for Exercise 14.

We start by showing that the rangespaces form a chain. If  $\vec{w} \in \mathcal{R}(t^{j+1})$ , so that  $\vec{w} = t^{j+1}(\vec{v})$ , then  $\vec{w} = t^j(t(\vec{v}))$ . Thus  $\vec{w} \in \mathcal{R}(t^j)$ .

Next we verify the “further” property: while the subsets in the chain of rangespaces may be proper for a while, from some power  $k$  onward the rangespaces are equal. We first show that if any pair of adjacent rangespaces in the chain are equal  $\mathcal{R}(t^k) = \mathcal{R}(t^{k+1})$  then all subsequent ones are also equal  $\mathcal{R}(t^{k+1}) =$

$\mathcal{R}(t^{k+2})$ , etc. This holds because  $t: \mathcal{R}(t^{k+1}) \rightarrow \mathcal{R}(t^{k+2})$  is the same map, with the same domain, as  $t: \mathcal{R}(t^k) \rightarrow \mathcal{R}(t^{k+1})$  and it therefore has the same range  $\mathcal{R}(t^{k+1}) = \mathcal{R}(t^{k+2})$  (it holds for all higher powers by induction). So if the chain of rangespaces ever stops strictly decreasing then from that point onward it is stable.

We end by showing that the chain must eventually stop decreasing. Each rangespace is a subspace of the one before it. For it to be a proper subspace it must be of strictly lower dimension (see Exercise 12). These spaces are finite-dimensional and so the chain can fall for only finitely-many steps, that is, the power  $k$  is at most the dimension of  $V$ . QED

**1.5 Example** The derivative map  $a + bx + cx^2 + dx^3 \xrightarrow{d/dx} b + 2cx + 3dx^2$  on  $\mathcal{P}_3$  has this chain of rangespaces

$$\mathcal{R}(t^0) = \mathcal{P}_3 \supset \mathcal{R}(t^1) = \mathcal{P}_2 \supset \mathcal{R}(t^2) = \mathcal{P}_1 \supset \mathcal{R}(t^3) = \mathcal{P}_0 \supset \mathcal{R}(t^4) = \{\vec{0}\}$$

(all later elements of the chain are the trivial space). And it has this chain of nullspaces

$$\mathcal{N}(t^0) = \{\vec{0}\} \subset \mathcal{N}(t^1) = \mathcal{P}_0 \subset \mathcal{N}(t^2) = \mathcal{P}_1 \subset \mathcal{N}(t^3) = \mathcal{P}_2 \subset \mathcal{N}(t^4) = \mathcal{P}_3$$

(later elements are the entire space).

**1.6 Example** Let  $t: \mathcal{P}_2 \rightarrow \mathcal{P}_2$  be the map  $c_0 + c_1x + c_2x^2 \mapsto 2c_0 + c_2x$ . As the lemma describes, on iteration the rangespace shrinks

$$\mathcal{R}(t^0) = \mathcal{P}_2 \quad \mathcal{R}(t) = \{a + bx \mid a, b \in \mathbb{C}\} \quad \mathcal{R}(t^2) = \{a \mid a \in \mathbb{C}\}$$

and then stabilizes  $\mathcal{R}(t^2) = \mathcal{R}(t^3) = \dots$  while the nullspace grows

$$\mathcal{N}(t^0) = \{0\} \quad \mathcal{N}(t) = \{cx \mid c \in \mathbb{C}\} \quad \mathcal{N}(t^2) = \{cx + d \mid c, d \in \mathbb{C}\}$$

and then stabilizes  $\mathcal{N}(t^2) = \mathcal{N}(t^3) = \dots$ .

**1.7 Example** The transformation  $\pi: \mathbb{C}^3 \rightarrow \mathbb{C}^3$  projecting onto the first two coordinates

$$\begin{pmatrix} c_1 \\ c_2 \\ c_3 \end{pmatrix} \xrightarrow{\pi} \begin{pmatrix} c_1 \\ c_2 \\ 0 \end{pmatrix}$$

has  $\mathbb{C}^3 \supset \mathcal{R}(\pi) = \mathcal{R}(\pi^2) = \dots$  and  $\{\vec{0}\} \subset \mathcal{N}(\pi) = \mathcal{N}(\pi^2) = \dots$  where this is the rangespace and the nullspace.

$$\mathcal{R}(\pi) = \left\{ \begin{pmatrix} a \\ b \\ 0 \end{pmatrix} \mid a, b \in \mathbb{C} \right\} \quad \mathcal{N}(\pi) = \left\{ \begin{pmatrix} 0 \\ 0 \\ c \end{pmatrix} \mid c \in \mathbb{C} \right\}$$

**1.8 Definition** Let  $t$  be a transformation on an  $n$ -dimensional space. The *generalized rangespace* (or the *closure of the rangespace*) is  $\mathcal{R}_\infty(t) = \mathcal{R}(t^n)$ . The *generalized nullspace* (or the *closure of the nullspace*) is  $\mathcal{N}_\infty(t) = \mathcal{N}(t^n)$ .

This graph illustrates. The horizontal axis gives the power  $j$  of a transformation. The vertical axis gives the dimension of the rangespace of  $t^j$  as the distance above zero, and thus also shows the dimension of the nullspace because the two add to the dimension  $n$  of the domain.

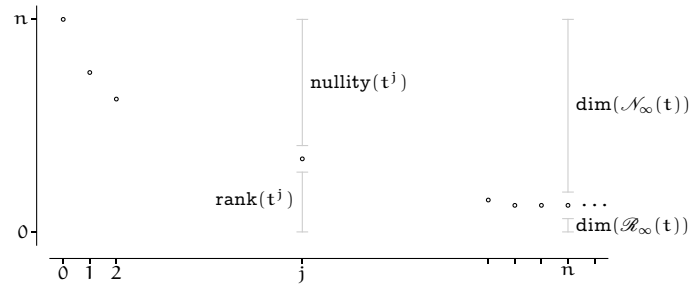

On iteration the rank falls and the nullity rises until there is some  $k$  such that the map reaches a steady state  $\mathcal{R}(t^k) = \mathcal{R}(t^{k+1}) = \mathcal{R}_\infty(t)$  and  $\mathcal{N}(t^k) = \mathcal{N}(t^{k+1}) = \mathcal{N}_\infty(t)$ . This must happen by the  $n$ -th iterate.

### Exercises

✓ 1.9 Give the chains of rangespaces and nullspaces for the zero and identity transformations.

✓ 1.10 For each map, give the chain of rangespaces and the chain of nullspaces, and the generalized rangespace and the generalized nullspace.

(a)  $t_0: \mathcal{P}_2 \rightarrow \mathcal{P}_2, a + bx + cx^2 \mapsto b + cx^2$

(b)  $t_1: \mathbb{R}^2 \rightarrow \mathbb{R}^2,$

$$\begin{pmatrix} a \\ b \end{pmatrix} \mapsto \begin{pmatrix} 0 \\ a \end{pmatrix}$$

(c)  $t_2: \mathcal{P}_2 \rightarrow \mathcal{P}_2, a + bx + cx^2 \mapsto b + cx + ax^2$

(d)  $t_3: \mathbb{R}^3 \rightarrow \mathbb{R}^3,$

$$\begin{pmatrix} a \\ b \\ c \end{pmatrix} \mapsto \begin{pmatrix} a \\ a \\ b \end{pmatrix}$$

1.11 Prove that function composition is associative  $(t \circ t) \circ t = t \circ (t \circ t)$  and so we can write  $t^3$  without specifying a grouping.

1.12 Check that a subspace must be of dimension less than or equal to the dimension of its superspace. Check that if the subspace is proper (the subspace does not equal the superspace) then the dimension is strictly less. (*This is used in the proof of Lemma 1.4.*)

✓ 1.13 Prove that the generalized rangespace  $\mathcal{R}_\infty(t)$  is the entire space, and the generalized nullspace  $\mathcal{N}_\infty(t)$  is trivial, if the transformation  $t$  is nonsingular. Is this 'only if' also?

1.14 Verify the nullspace half of Lemma 1.4.

✓ 1.15 Give an example of a transformation on a three dimensional space whose range has dimension two. What is its nullspace? Iterate your example until the rangespace and nullspace stabilize.

1.16 Show that the rangespace and nullspace of a linear transformation need not be disjoint. Are they ever disjoint?



## III.2 Strings

*This subsection requires material from the optional Direct Sum subsection.*

The prior subsection shows that as  $j$  increases, the dimensions of the  $\mathcal{R}(t^j)$ 's fall while the dimensions of the  $\mathcal{N}(t^j)$ 's rise, in such a way that this rank and nullity split between them the dimension of  $V$ . Can we say more; do the two split a basis — is  $V = \mathcal{R}(t^j) \oplus \mathcal{N}(t^j)$ ?

The answer is yes for the smallest power  $j = 0$  since  $V = \mathcal{R}(t^0) \oplus \mathcal{N}(t^0) = V \oplus \{\vec{0}\}$ . The answer is also yes at the other extreme.

**2.1 Lemma** For any linear  $t: V \rightarrow V$  the function  $t: \mathcal{R}_\infty(t) \rightarrow \mathcal{R}_\infty(t)$  is one-to-one.

**PROOF** Let the dimension of  $V$  be  $n$ . Because  $\mathcal{R}(t^n) = \mathcal{R}(t^{n+1})$ , the map  $t: \mathcal{R}_\infty(t) \rightarrow \mathcal{R}_\infty(t)$  is a dimension-preserving homomorphism. Therefore, by Theorem Two.II.2.20 it is one-to-one. QED

**2.2 Corollary** Where  $t: V \rightarrow V$  is a linear transformation, the space is the direct sum  $V = \mathcal{R}_\infty(t) \oplus \mathcal{N}_\infty(t)$ . That is, both (1)  $\dim(V) = \dim(\mathcal{R}_\infty(t)) + \dim(\mathcal{N}_\infty(t))$  and (2)  $\mathcal{R}_\infty(t) \cap \mathcal{N}_\infty(t) = \{\vec{0}\}$ .

**PROOF** Let the dimension of  $V$  be  $n$ . We will verify the second sentence, which is equivalent to the first. Clause (1) is true because any transformation satisfies that its rank plus its nullity equals the dimension of the space, and in particular this holds for the transformation  $t^n$ . Thus we need only verify clause (2).

Assume that  $\vec{v} \in \mathcal{R}_\infty(t) \cap \mathcal{N}_\infty(t)$  to prove that  $\vec{v} = \vec{0}$ . Because  $\vec{v}$  is in the generalized nullspace,  $t^n(\vec{v}) = \vec{0}$ . On the other hand, by the lemma  $t: \mathcal{R}_\infty(t) \rightarrow \mathcal{R}_\infty(t)$  is one-to-one, and a composition of one-to-one maps is one-to-one, so  $t^n: \mathcal{R}_\infty(t) \rightarrow \mathcal{R}_\infty(t)$  is one-to-one. Only  $\vec{0}$  is sent by a one-to-one linear map to  $\vec{0}$  so the fact that  $t^n(\vec{v}) = \vec{0}$  implies that  $\vec{v} = \vec{0}$ . QED

**2.3 Remark** Technically there is a difference between the map  $t: V \rightarrow V$  and the map on the subspace  $t: \mathcal{R}_\infty(t) \rightarrow \mathcal{R}_\infty(t)$  if the generalized rangespace is not equal to  $V$ , because the domains are different. The second is the *restriction*\* of the first to  $\mathcal{R}_\infty(t)$ .

For powers between  $j = 0$  and  $j = n$ , the space  $V$  might not be the direct sum of  $\mathcal{R}(t^j)$  and  $\mathcal{N}(t^j)$ . The next example shows that the two can have a nontrivial intersection.

**2.4 Example** Consider the transformation of  $\mathbb{C}^2$  defined by this action on the elements of the standard basis.

$$\begin{pmatrix} 1 \\ 0 \end{pmatrix} \xrightarrow{N} \begin{pmatrix} 0 \\ 1 \end{pmatrix} \quad \begin{pmatrix} 0 \\ 1 \end{pmatrix} \xrightarrow{N} \begin{pmatrix} 0 \\ 0 \end{pmatrix} \quad N = \text{Rep}_{\mathcal{E}_2, \mathcal{E}_2}(N) = \begin{pmatrix} 0 & 0 \\ 1 & 0 \end{pmatrix}$$

\* More information on map restrictions is in the appendix.

This is a shift map.

$$\begin{pmatrix} x \\ y \end{pmatrix} \mapsto \begin{pmatrix} 0 \\ x \end{pmatrix}$$

Another way to depict this map's action is with a *string*.

$$\vec{e}_1 \mapsto \vec{e}_2 \mapsto \vec{0}$$

The vector

$$\vec{e}_2 = \begin{pmatrix} 0 \\ 1 \end{pmatrix}$$

is in both the rangespace and nullspace.

**2.5 Example** A map  $\hat{n}: \mathbb{C}^4 \rightarrow \mathbb{C}^4$  whose action on  $\mathcal{E}_4$  is given by the string

$$\vec{e}_1 \mapsto \vec{e}_2 \mapsto \vec{e}_3 \mapsto \vec{e}_4 \mapsto \vec{0}$$

has  $\mathcal{R}(\hat{n}) \cap \mathcal{N}(\hat{n})$  equal to the span  $\{[\vec{e}_4]\}$ , has  $\mathcal{R}(\hat{n}^2) \cap \mathcal{N}(\hat{n}^2) = \{[\vec{e}_3, \vec{e}_4]\}$ , and has  $\mathcal{R}(\hat{n}^3) \cap \mathcal{N}(\hat{n}^3) = \{[\vec{e}_4]\}$ . The matrix representation is all zeros except for some subdiagonal ones.

$$\hat{N} = \text{Rep}_{\mathcal{E}_4, \mathcal{E}_4}(\hat{n}) = \begin{pmatrix} 0 & 0 & 0 & 0 \\ 1 & 0 & 0 & 0 \\ 0 & 1 & 0 & 0 \\ 0 & 0 & 1 & 0 \end{pmatrix}$$

**2.6 Example** Transformations can act via more than one string. A transformation  $t$  acting on a basis  $B = \{\vec{\beta}_1, \dots, \vec{\beta}_5\}$  by

$$\begin{aligned} \vec{\beta}_1 &\mapsto \vec{\beta}_2 \mapsto \vec{\beta}_3 \mapsto \vec{0} \\ \vec{\beta}_4 &\mapsto \vec{\beta}_5 \mapsto \vec{0} \end{aligned}$$

is represented by a matrix that is all zeros except for blocks of subdiagonal ones

$$\text{Rep}_{B, B}(t) = \left( \begin{array}{ccc|cc} 0 & 0 & 0 & 0 & 0 \\ 1 & 0 & 0 & 0 & 0 \\ 0 & 1 & 0 & 0 & 0 \\ \hline 0 & 0 & 0 & 0 & 0 \\ 0 & 0 & 0 & 1 & 0 \end{array} \right)$$

(the lines just visually organize the blocks).

In those examples all vectors are eventually transformed to zero.

**2.7 Definition** A *nilpotent* transformation is one with a power that is the zero map. A *nilpotent matrix* is one with a power that is the zero matrix. In either case, the least such power is the *index of nilpotency*.

**2.8 Example** In Example 2.4 the index of nilpotency is two. In Example 2.5 it is four. In Example 2.6 it is three.

**2.9 Example** The differentiation map  $d/dx: \mathcal{P}_2 \rightarrow \mathcal{P}_2$  is nilpotent of index three since the third derivative of any quadratic polynomial is zero. This map's action is described by the string  $x^2 \mapsto 2x \mapsto 2 \mapsto 0$  and taking the basis  $B = \langle x^2, 2x, 2 \rangle$  gives this representation.

$$\text{Rep}_{B,B}(d/dx) = \begin{pmatrix} 0 & 0 & 0 \\ 1 & 0 & 0 \\ 0 & 1 & 0 \end{pmatrix}$$

Not all nilpotent matrices are all zeros except for blocks of subdiagonal ones.

**2.10 Example** With the matrix  $\hat{N}$  from Example 2.5, and this four-vector basis

$$D = \left\langle \begin{pmatrix} 1 \\ 0 \\ 1 \\ 0 \end{pmatrix}, \begin{pmatrix} 0 \\ 2 \\ 1 \\ 0 \end{pmatrix}, \begin{pmatrix} 1 \\ 1 \\ 1 \\ 0 \end{pmatrix}, \begin{pmatrix} 0 \\ 0 \\ 0 \\ 1 \end{pmatrix} \right\rangle$$

a change of basis operation produces this representation with respect to  $D, D$ .

$$\begin{pmatrix} 1 & 0 & 1 & 0 \\ 0 & 2 & 1 & 0 \\ 1 & 1 & 1 & 0 \\ 0 & 0 & 0 & 1 \end{pmatrix} \begin{pmatrix} 0 & 0 & 0 & 0 \\ 1 & 0 & 0 & 0 \\ 0 & 1 & 0 & 0 \\ 0 & 0 & 1 & 0 \end{pmatrix} \begin{pmatrix} 1 & 0 & 1 & 0 \\ 0 & 2 & 1 & 0 \\ 1 & 1 & 1 & 0 \\ 0 & 0 & 0 & 1 \end{pmatrix}^{-1} = \begin{pmatrix} -1 & 0 & 1 & 0 \\ -3 & -2 & 5 & 0 \\ -2 & -1 & 3 & 0 \\ 2 & 1 & -2 & 0 \end{pmatrix}$$

The new matrix is nilpotent; its fourth power is the zero matrix. We could verify this with a tedious computation, or we can observe that it is nilpotent since it is similar to the nilpotent matrix  $\hat{N}^4$ .

$$(P\hat{N}P^{-1})^4 = P\hat{N}P^{-1} \cdot P\hat{N}P^{-1} \cdot P\hat{N}P^{-1} \cdot P\hat{N}P^{-1} = P\hat{N}^4P^{-1}$$

The goal of this subsection is to show that the prior example is prototypical in that every nilpotent matrix is similar to one that is all zeros except for blocks of subdiagonal ones.

**2.11 Definition** Let  $t$  be a nilpotent transformation on  $V$ . A  $t$ -string of length  $k$  generated by  $\vec{v} \in V$  is a sequence  $\langle \vec{v}, t(\vec{v}), \dots, t^{k-1}(\vec{v}) \rangle$ . A  $t$ -string basis is a basis that is a concatenation of  $t$ -strings.

Note that the strings cannot form a basis under concatenation if they are not disjoint because a basis cannot have a repeated vector.

**2.12 Example** In Example 2.6, we can concatenate the  $t$ -strings  $\langle \vec{\beta}_1, \vec{\beta}_2, \vec{\beta}_3 \rangle$  and  $\langle \vec{\beta}_4, \vec{\beta}_5 \rangle$ , of length three and two, to make a basis for the domain of  $t$ .

**2.13 Lemma** If a space has a basis of  $t$ -strings then the longest string in that basis has length equal to the index of nilpotency of  $t$ .

PROOF Suppose not. Those strings cannot be longer; if the index is  $k$  then  $t^k$  sends any vector—including those starting the string—to  $\vec{0}$ . So suppose instead that there is a transformation  $t$  of index  $k$  on some space, such that the space has a  $t$ -string basis where all of the strings are shorter than length  $k$ . Because  $t$  has index  $k$ , there is a vector  $\vec{v}$  such that  $t^{k-1}(\vec{v}) \neq \vec{0}$ . Represent  $\vec{v}$  as a linear combination of basis elements and apply  $t^{k-1}$ . We are supposing that  $t^{k-1}$  sends each basis element to  $\vec{0}$  but that it does not send  $\vec{v}$  to  $\vec{0}$ . That is impossible. QED

We shall show that every nilpotent map has an associated string basis.

Looking for a counterexample, a nilpotent map without an associated string basis that is disjoint, will suggest the idea for the proof. Consider the map  $t: \mathbb{C}^5 \rightarrow \mathbb{C}^5$  with this action.

$$\begin{array}{l} \vec{e}_1 \mapsto \vec{e}_3 \mapsto \vec{0} \\ \vec{e}_2 \mapsto \vec{e}_3 \mapsto \vec{0} \\ \vec{e}_4 \mapsto \vec{e}_5 \mapsto \vec{0} \end{array} \quad \text{Rep}_{\mathcal{E}_5, \mathcal{E}_5}(t) = \begin{pmatrix} 0 & 0 & 0 & 0 & 0 \\ 0 & 0 & 0 & 0 & 0 \\ 1 & 1 & 0 & 0 & 0 \\ 0 & 0 & 0 & 0 & 0 \\ 0 & 0 & 0 & 1 & 0 \end{pmatrix}$$

These three strings aren't disjoint. The first two strings  $\vec{e}_1 \mapsto \vec{e}_3 \mapsto \vec{0}$  and  $\vec{e}_2 \mapsto \vec{e}_3 \mapsto \vec{0}$  overlap, even after omitting  $\vec{0}$ . But that doesn't mean that there is no  $t$ -string basis; it only means that  $\mathcal{E}_5$  is not one.

To find a basis we first find the number and lengths of its strings. Since  $t$ 's index of nilpotency is two, Lemma 2.13 says that at least one string in the basis has length two. Thus the map must act on a string basis in one of these two ways.

$$\begin{array}{l} \vec{\beta}_1 \mapsto \vec{\beta}_2 \mapsto \vec{0} \\ \vec{\beta}_3 \mapsto \vec{\beta}_4 \mapsto \vec{0} \\ \vec{\beta}_5 \mapsto \vec{0} \end{array} \quad \begin{array}{l} \vec{\beta}_1 \mapsto \vec{\beta}_2 \mapsto \vec{0} \\ \vec{\beta}_3 \mapsto \vec{0} \\ \vec{\beta}_4 \mapsto \vec{0} \\ \vec{\beta}_5 \mapsto \vec{0} \end{array}$$

Now, the key point. A transformation with the left-hand action has a nullspace of dimension three since that's how many basis vectors are mapped to zero. A transformation with the right-hand action has a nullspace of dimension four. Using the matrix representation above, calculation of  $t$ 's nullspace

$$\mathcal{N}(t) = \left\{ \begin{pmatrix} x \\ -x \\ z \\ 0 \\ r \end{pmatrix} \mid x, z, r \in \mathbb{C} \right\}$$

shows that it is three-dimensional, meaning that we want the left-hand action.

To produce a string basis, first pick  $\vec{\beta}_2$  and  $\vec{\beta}_4$  from  $\mathcal{R}(t) \cap \mathcal{N}(t)$

$$\vec{\beta}_2 = \begin{pmatrix} 0 \\ 0 \\ 1 \\ 0 \\ 0 \end{pmatrix} \quad \vec{\beta}_4 = \begin{pmatrix} 0 \\ 0 \\ 0 \\ 0 \\ 1 \end{pmatrix}$$

(other choices are possible, just be sure that  $\{\vec{\beta}_2, \vec{\beta}_4\}$  is linearly independent).  
 For  $\vec{\beta}_5$  pick a vector from  $\mathcal{N}(t)$  that is not in the span of  $\{\vec{\beta}_2, \vec{\beta}_4\}$ .

$$\vec{\beta}_5 = \begin{pmatrix} 1 \\ -1 \\ 0 \\ 0 \\ 0 \end{pmatrix}$$

Finally, take  $\vec{\beta}_1$  and  $\vec{\beta}_3$  such that  $t(\vec{\beta}_1) = \vec{\beta}_2$  and  $t(\vec{\beta}_3) = \vec{\beta}_4$ .

$$\vec{\beta}_1 = \begin{pmatrix} 0 \\ 1 \\ 0 \\ 0 \\ 0 \end{pmatrix} \quad \vec{\beta}_3 = \begin{pmatrix} 0 \\ 0 \\ 0 \\ 1 \\ 0 \end{pmatrix}$$

Now, with respect to  $B = \langle \vec{\beta}_1, \dots, \vec{\beta}_5 \rangle$ , the matrix of  $t$  is as desired.

$$\text{Rep}_{B,B}(t) = \left( \begin{array}{cc|cc|c} 0 & 0 & 0 & 0 & 0 \\ 1 & 0 & 0 & 0 & 0 \\ \hline 0 & 0 & 0 & 0 & 0 \\ 0 & 0 & 1 & 0 & 0 \\ \hline 0 & 0 & 0 & 0 & 0 \end{array} \right)$$

**2.14 Theorem** Any nilpotent transformation  $t$  is associated with a  $t$ -string basis. While the basis is not unique, the number and the length of the strings is determined by  $t$ .

This illustrates the argument below, which describes three kinds of basis vectors (we shown them in squares if they are in the nullspace and in circles if they are not).

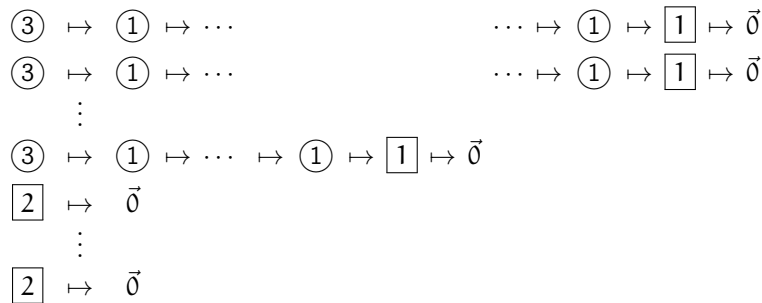

PROOF Fix a vector space  $V$ . We will argue by induction on the index of nilpotency. If the map  $t: V \rightarrow V$  has index of nilpotency 1 then it is the zero map and any basis is a string basis  $\vec{\beta}_1 \mapsto \vec{0}, \dots, \vec{\beta}_n \mapsto \vec{0}$ .

For the inductive step, assume that the theorem holds for any transformation  $t: V \rightarrow V$  with an index of nilpotency between 1 and  $k-1$  (with  $k > 1$ ) and consider the index  $k$  case.

Observe that the restriction of  $t$  to the rangespace  $t: \mathcal{R}(t) \rightarrow \mathcal{R}(t)$  is also nilpotent, of index  $k-1$ . Apply the inductive hypothesis to get a string basis for  $\mathcal{R}(t)$ , where the number and length of the strings is determined by  $t$ .

$$B = \langle \vec{\beta}_1, t(\vec{\beta}_1), \dots, t^{h_1}(\vec{\beta}_1) \rangle \wedge \langle \vec{\beta}_2, \dots, t^{h_2}(\vec{\beta}_2) \rangle \wedge \dots \wedge \langle \vec{\beta}_i, \dots, t^{h_i}(\vec{\beta}_i) \rangle$$

(In the illustration above these are the vectors of kind 1.)

Note that taking the final nonzero vector in each of these strings gives a basis  $C = \langle t^{h_1}(\vec{\beta}_1), \dots, t^{h_i}(\vec{\beta}_i) \rangle$  for the intersection  $\mathcal{R}(t) \cap \mathcal{N}(t)$ . This is because a member of  $\mathcal{R}(t)$  maps to zero if and only if it is a linear combination of those basis vectors that map to zero. (The illustration shows these as 1's in squares.)

Now extend  $C$  to a basis for all of  $\mathcal{N}(t)$ .

$$\hat{C} = C \wedge \langle \vec{\xi}_1, \dots, \vec{\xi}_p \rangle$$

(In the illustration the  $\vec{\xi}$ 's are the vectors of kind 2 and so the set  $\hat{C}$  is the set of all vectors in a square.) While which vectors  $\vec{\xi}$  we choose isn't uniquely determined by  $t$ , what is uniquely determined is the number of them: it is the dimension of  $\mathcal{N}(t)$  minus the dimension of  $\mathcal{R}(t) \cap \mathcal{N}(t)$ .

Finally,  $B \wedge \hat{C}$  is a basis for  $\mathcal{R}(t) + \mathcal{N}(t)$  because any sum of something in the rangespace with something in the nullspace can be represented using elements of  $B$  for the rangespace part and elements of  $\hat{C}$  for the part from the nullspace. Note that

$$\begin{aligned} \dim(\mathcal{R}(t) + \mathcal{N}(t)) &= \dim(\mathcal{R}(t)) + \dim(\mathcal{N}(t)) - \dim(\mathcal{R}(t) \cap \mathcal{N}(t)) \\ &= \text{rank}(t) + \text{nullity}(t) - i \\ &= \dim(V) - i \end{aligned}$$

and so we can extend  $B \wedge \hat{C}$  to a basis for all of  $V$  by the addition of  $i$  more vectors, provided they are not linearly dependent on what we have already. Recall that each of  $\vec{\beta}_1, \dots, \vec{\beta}_i$  is in  $\mathcal{R}(t)$ , and extend  $B \wedge \hat{C}$  with vectors  $\vec{v}_1, \dots, \vec{v}_i$  such that  $t(\vec{v}_1) = \vec{\beta}_1, \dots, t(\vec{v}_i) = \vec{\beta}_i$ . (In the illustration these are the 3's.) The check that this extension preserves linear independence is Exercise 30. QED

**2.15 Corollary** Every nilpotent matrix is similar to a matrix that is all zeros except for blocks of subdiagonal ones. That is, every nilpotent map is represented with respect to some basis by such a matrix.

This form is unique in the sense that if a nilpotent matrix is similar to two such matrices then those two simply have their blocks ordered differently. Thus this is a canonical form for the similarity classes of nilpotent matrices provided that we order the blocks, say, from longest to shortest.

**2.16 Example** The matrix

$$M = \begin{pmatrix} 1 & -1 \\ 1 & -1 \end{pmatrix}$$

has an index of nilpotency of two, as this calculation shows.

power $p$	$M^p$	$\mathcal{N}(M^p)$
1	$M = \begin{pmatrix} 1 & -1 \\ 1 & -1 \end{pmatrix}$	$\left\{ \begin{pmatrix} x \\ x \end{pmatrix} \mid x \in \mathbb{C} \right\}$
2	$M^2 = \begin{pmatrix} 0 & 0 \\ 0 & 0 \end{pmatrix}$	$\mathbb{C}^2$

The calculation also describes how a map  $m$  represented by  $M$  must act on any string basis. With one map application the nullspace has dimension one and so one vector of the basis maps to zero. On a second application, the nullspace has dimension two and so the other basis vector maps to zero. Thus, the action of the linear transformation is  $\vec{\beta}_1 \mapsto \vec{\beta}_2 \mapsto \vec{0}$  and the canonical form of the matrix is this.

$$\begin{pmatrix} 0 & 0 \\ 1 & 0 \end{pmatrix}$$

We can exhibit such a  $m$ -string basis and the change of basis matrices witnessing the matrix similarity. For the basis, take  $M$  to represent  $m$  with respect to the standard bases. (We could take  $M$  to be a representative with respect to some other basis but the standard basis is convenient.) Pick a  $\vec{\beta}_2 \in \mathcal{N}(m)$  and also pick a  $\vec{\beta}_1$  so that  $m(\vec{\beta}_1) = \vec{\beta}_2$ .

$$\vec{\beta}_2 = \begin{pmatrix} 1 \\ 1 \end{pmatrix} \quad \vec{\beta}_1 = \begin{pmatrix} 1 \\ 0 \end{pmatrix}$$

Recall the similarity diagram.

$$\begin{array}{ccc} \mathbb{C}_{\text{wrt } \mathcal{E}_2}^2 & \xrightarrow[M]{m} & \mathbb{C}_{\text{wrt } \mathcal{E}_2}^2 \\ \text{id} \downarrow P & & \text{id} \downarrow P \\ \mathbb{C}_{\text{wrt } B}^2 & \xrightarrow{m} & \mathbb{C}_{\text{wrt } B}^2 \end{array}$$

The canonical form equals  $\text{Rep}_{B,B}(m) = PMP^{-1}$ , where

$$P^{-1} = \text{Rep}_{B, \mathcal{E}_2}(\text{id}) = \begin{pmatrix} 1 & 1 \\ 0 & 1 \end{pmatrix} \quad P = (P^{-1})^{-1} = \begin{pmatrix} 1 & -1 \\ 0 & 1 \end{pmatrix}$$

and the verification of the matrix calculation is routine.

$$\begin{pmatrix} 1 & -1 \\ 0 & 1 \end{pmatrix} \begin{pmatrix} 1 & -1 \\ 1 & -1 \end{pmatrix} \begin{pmatrix} 1 & 1 \\ 0 & 1 \end{pmatrix} = \begin{pmatrix} 0 & 0 \\ 1 & 0 \end{pmatrix}$$

## 2.17 Example The matrix

$$\begin{pmatrix} 0 & 0 & 0 & 0 & 0 \\ 1 & 0 & 0 & 0 & 0 \\ -1 & 1 & 1 & -1 & 1 \\ 0 & 1 & 0 & 0 & 0 \\ 1 & 0 & -1 & 1 & -1 \end{pmatrix}$$

is nilpotent.

power p	$N^p$	$\mathcal{N}(N^p)$
1	$\begin{pmatrix} 0 & 0 & 0 & 0 & 0 \\ 1 & 0 & 0 & 0 & 0 \\ -1 & 1 & 1 & -1 & 1 \\ 0 & 1 & 0 & 0 & 0 \\ 1 & 0 & -1 & 1 & -1 \end{pmatrix}$	$\begin{pmatrix} 0 \\ 0 \\ u-v \\ u \\ v \end{pmatrix} \mid u, v \in \mathbb{C}$
2	$\begin{pmatrix} 0 & 0 & 0 & 0 & 0 \\ 0 & 0 & 0 & 0 & 0 \\ 1 & 0 & 0 & 0 & 0 \\ 1 & 0 & 0 & 0 & 0 \\ 0 & 0 & 0 & 0 & 0 \end{pmatrix}$	$\begin{pmatrix} 0 \\ y \\ z \\ u \\ v \end{pmatrix} \mid y, z, u, v \in \mathbb{C}$
3	-zero matrix-	$\mathbb{C}^5$

That table shows that any string basis must satisfy: the nullspace after one map application has dimension two so two basis vectors map directly to zero, the nullspace after the second application has dimension four so two additional basis vectors map to zero by the second iteration, and the nullspace after three applications is of dimension five so the final basis vector maps to zero in three hops.

$$\begin{aligned} \vec{\beta}_1 &\mapsto \vec{\beta}_2 \mapsto \vec{\beta}_3 \mapsto \vec{0} \\ \vec{\beta}_4 &\mapsto \vec{\beta}_5 \mapsto \vec{0} \end{aligned}$$

To produce such a basis, first pick two independent vectors from  $\mathcal{N}(n)$

$$\vec{\beta}_3 = \begin{pmatrix} 0 \\ 0 \\ 1 \\ 1 \\ 0 \end{pmatrix} \quad \vec{\beta}_5 = \begin{pmatrix} 0 \\ 0 \\ 0 \\ 1 \\ 1 \end{pmatrix}$$

then add  $\vec{\beta}_2, \vec{\beta}_4 \in \mathcal{N}(n^2)$  such that  $n(\vec{\beta}_2) = \vec{\beta}_3$  and  $n(\vec{\beta}_4) = \vec{\beta}_5$

$$\vec{\beta}_2 = \begin{pmatrix} 0 \\ 1 \\ 0 \\ 0 \\ 0 \end{pmatrix} \quad \vec{\beta}_4 = \begin{pmatrix} 0 \\ 1 \\ 0 \\ 1 \\ 0 \end{pmatrix}$$



and finish by adding  $\vec{\beta}_1 \in \mathcal{N}(\mathfrak{n}^3) = \mathbb{C}^5$  such that  $\mathfrak{n}(\vec{\beta}_1) = \vec{\beta}_2$ .

$$\vec{\beta}_1 = \begin{pmatrix} 1 \\ 0 \\ 1 \\ 0 \\ 0 \end{pmatrix}$$

### Exercises

- ✓ **2.18** What is the index of nilpotency of the *left-shift* operator, here acting on the space of triples of reals?

$$(x, y, z) \mapsto (0, x, y)$$

- ✓ **2.19** For each string basis state the index of nilpotency and give the dimension of the rangespace and nullspace of each iteration of the nilpotent map.

(a)  $\vec{\beta}_1 \mapsto \vec{\beta}_2 \mapsto \vec{0}$   
 $\vec{\beta}_3 \mapsto \vec{\beta}_4 \mapsto \vec{0}$

(b)  $\vec{\beta}_1 \mapsto \vec{\beta}_2 \mapsto \vec{\beta}_3 \mapsto \vec{0}$   
 $\vec{\beta}_4 \mapsto \vec{0}$   
 $\vec{\beta}_5 \mapsto \vec{0}$   
 $\vec{\beta}_6 \mapsto \vec{0}$

(c)  $\vec{\beta}_1 \mapsto \vec{\beta}_2 \mapsto \vec{\beta}_3 \mapsto \vec{0}$

Also give the canonical form of the matrix.

- 2.20** Decide which of these matrices are nilpotent.

(a)  $\begin{pmatrix} -2 & 4 \\ -1 & 2 \end{pmatrix}$  (b)  $\begin{pmatrix} 3 & 1 \\ 1 & 3 \end{pmatrix}$  (c)  $\begin{pmatrix} -3 & 2 & 1 \\ -3 & 2 & 1 \\ -3 & 2 & 1 \end{pmatrix}$  (d)  $\begin{pmatrix} 1 & 1 & 4 \\ 3 & 0 & -1 \\ 5 & 2 & 7 \end{pmatrix}$

(e)  $\begin{pmatrix} 45 & -22 & -19 \\ 33 & -16 & -14 \\ 69 & -34 & -29 \end{pmatrix}$

- ✓ **2.21** Find the canonical form of this matrix.

$$\begin{pmatrix} 0 & 1 & 1 & 0 & 1 \\ 0 & 0 & 1 & 1 & 1 \\ 0 & 0 & 0 & 0 & 0 \\ 0 & 0 & 0 & 0 & 0 \\ 0 & 0 & 0 & 0 & 0 \end{pmatrix}$$

- ✓ **2.22** Consider the matrix from Example 2.17.

- (a) Use the action of the map on the string basis to give the canonical form.  
 (b) Find the change of basis matrices that bring the matrix to canonical form.  
 (c) Use the answer in the prior item to check the answer in the first item.

- ✓ **2.23** Each of these matrices is nilpotent.

(a)  $\begin{pmatrix} 1/2 & -1/2 \\ 1/2 & -1/2 \end{pmatrix}$  (b)  $\begin{pmatrix} 0 & 0 & 0 \\ 0 & -1 & 1 \\ 0 & -1 & 1 \end{pmatrix}$  (c)  $\begin{pmatrix} -1 & 1 & -1 \\ 1 & 0 & 1 \\ 1 & -1 & 1 \end{pmatrix}$

Put each in canonical form.

- 2.24** Describe the effect of left or right multiplication by a matrix that is in the canonical form for nilpotent matrices.

- 2.25** Is nilpotence invariant under similarity? That is, must a matrix similar to a nilpotent matrix also be nilpotent? If so, with the same index?

- ✓ 2.26 Show that the only eigenvalue of a nilpotent matrix is zero.
- 2.27 Is there a nilpotent transformation of index three on a two-dimensional space?
- 2.28 In the proof of Theorem 2.14, why isn't the proof's base case that the index of nilpotency is zero?
- ✓ 2.29 Let  $t: V \rightarrow V$  be a linear transformation and suppose  $\vec{v} \in V$  is such that  $t^k(\vec{v}) = \vec{0}$  but  $t^{k-1}(\vec{v}) \neq \vec{0}$ . Consider the  $t$ -string  $\langle \vec{v}, t(\vec{v}), \dots, t^{k-1}(\vec{v}) \rangle$ .
- Prove that  $t$  is a transformation on the span of the set of vectors in the string, that is, prove that  $t$  restricted to the span has a range that is a subset of the span. We say that the span is a  $t$ -invariant subspace.
  - Prove that the restriction is nilpotent.
  - Prove that the  $t$ -string is linearly independent and so is a basis for its span.
  - Represent the restriction map with respect to the  $t$ -string basis.
- 2.30 Finish the proof of Theorem 2.14.
- 2.31 Show that the terms 'nilpotent transformation' and 'nilpotent matrix', as given in Definition 2.7, fit with each other: a map is nilpotent if and only if it is represented by a nilpotent matrix. (Is it that a transformation is nilpotent if and only if there is a basis such that the map's representation with respect to that basis is a nilpotent matrix, or that any representation is a nilpotent matrix?)
- 2.32 Let  $T$  be nilpotent of index four. How big can the rangespace of  $T^3$  be?
- 2.33 Recall that similar matrices have the same eigenvalues. Show that the converse does not hold.
- 2.34 Lemma 2.1 shows that any for any linear transformation  $t: V \rightarrow V$  the restriction  $t: \mathcal{R}_\infty(t) \rightarrow \mathcal{R}_\infty(t)$  is one-to-one. Show that it is also onto, so it is an automorphism. Must it be the identity map?
- 2.35 Prove that a nilpotent matrix is similar to one that is all zeros except for blocks of super-diagonal ones.
- ✓ 2.36 Prove that if a transformation has the same rangespace as nullspace. then the dimension of its domain is even.
- 2.37 Prove that if two nilpotent matrices commute then their product and sum are also nilpotent.
- 2.38 Consider the transformation of  $\mathcal{M}_{n \times n}$  given by  $t_S(T) = ST - TS$  where  $S$  is an  $n \times n$  matrix. Prove that if  $S$  is nilpotent then so is  $t_S$ .
- 2.39 Show that if  $N$  is nilpotent then  $I - N$  is invertible. Is that 'only if' also?

## IV Jordan Form

*This section uses material from three optional subsections: Direct Sum, Determinants Exist, and Laplace's Expansion Formula.*

The chapter on linear maps shows that every  $h: V \rightarrow W$  can be represented by a partial identity matrix with respect to some bases  $B \subset V$  and  $D \subset W$  that is, that the partial identity form is a canonical form for matrix equivalence. This chapter considers the special case that the map is a linear transformation  $t: V \rightarrow V$ . The general result still applies so we can get a partial identity with respect to  $B, D$ , but with the codomain equal to the domain we naturally ask what is possible when the two bases are also equal so that we have  $\text{Rep}_{B,B}(t)$  — we will find a canonical form for matrix similarity.

We began by noting that while a partial identity matrix is the canonical form for the  $B, D$  case, in the  $B, B$  case there are some matrix similarity classes without one. We therefore extended the forms of interest to the natural generalization, diagonal matrices, and showed that the map or matrix can be diagonalized if its eigenvalues are distinct. But we also gave an example of a matrix that cannot be diagonalized (because it is nilpotent), and thus diagonal form won't do as the canonical form for all matrices.

The prior section developed that example. We showed that a linear map is nilpotent if and only if there is a basis on which it acts via disjoint strings. That gave us a canonical form that applied to nilpotent matrices.

This section wraps up the chapter by showing that the two cases we've studied are exhaustive in that for any linear transformation there is a basis such that the matrix representation  $\text{Rep}_{B,B}(t)$  is the sum of a diagonal matrix and a nilpotent matrix. This is Jordan canonical form.

### IV.1 Polynomials of Maps and Matrices

Recall that the set of square matrices is a vector space under entry-by-entry addition and scalar multiplication, and that this space  $\mathcal{M}_{n \times n}$  has dimension  $n^2$ . Thus, for any  $n \times n$  matrix  $T$  the  $n^2 + 1$ -member set  $\{I, T, T^2, \dots, T^{n^2}\}$  is linearly dependent and so there are scalars  $c_0, \dots, c_{n^2}$ , not all zero, such that

$$c_{n^2}T^{n^2} + \dots + c_1T + c_0I$$

is the zero matrix. That is, every transformation has a kind of generalized nilpotency: the powers of a square matrix cannot climb forever without a "repeat."

**1.1 Example** Rotation of plane vectors  $\pi/6$  radians counterclockwise is represented

with respect to the standard basis by

$$T = \begin{pmatrix} \sqrt{3}/2 & -1/2 \\ 1/2 & \sqrt{3}/2 \end{pmatrix}$$

and verifying that  $0T^4 + 0T^3 + 1T^2 - 2T - 1I$  equals the zero matrix is easy.

**1.2 Definition** For any polynomial  $f(x) = c_n x^n + \cdots + c_1 x + c_0$ , where  $t$  is a linear transformation then  $f(t)$  is the transformation  $c_n t^n + \cdots + c_1 t + c_0(\text{id})$  on the same space, and where  $T$  is a square matrix then  $f(T)$  is the matrix  $c_n T^n + \cdots + c_1 T + c_0 I$ .

The polynomial of the matrix represents the polynomial of the map: if  $T = \text{Rep}_{B,B}(t)$  then  $f(T) = \text{Rep}_{B,B}(f(t))$ . This is because  $T^j = \text{Rep}_{B,B}(t^j)$ , and  $cT = \text{Rep}_{B,B}(ct)$ , and  $T_1 + T_2 = \text{Rep}_{B,B}(t_1 + t_2)$ .

**1.3 Remark** Most authors write the matrix polynomial slightly differently than the map polynomial. For instance, if  $f(x) = x - 3$  then most authors explicitly write the identity matrix  $f(T) = T - 3I$  but don't write the identity map  $f(t) = t - 3$ . We shall follow this convention.

Consider again Example 1.1. Although  $T \in \mathcal{M}_{2 \times 2}$ , which is a dimension four space, we exhibited a polynomial of  $T$  that gave the zero matrix and was of degree less than four. So for any particular map or matrix, degree  $n^2$  will suffice but there may be a smaller degree polynomial that works.

**1.4 Definition** The *minimal polynomial*  $m(x)$  of a transformation  $t$  or a square matrix  $T$  is the polynomial of least degree and with leading coefficient one such that  $m(t)$  is the zero map or  $m(T)$  is the zero matrix.

The fact that leading coefficient must be one keeps a minimal polynomial from being the zero polynomial. That is, a minimal polynomial must have degree at least one. Thus, the zero matrix has minimal polynomial  $p(x) = x$  while the identity matrix has minimal polynomial  $\hat{p}(x) = x - 1$ .

**1.5 Lemma** Any transformation or square matrix has a unique minimal polynomial.

**PROOF** We first show existence. The earlier observation that degree  $n^2$  suffices shows that there is at least one nonzero polynomial  $p(x) = c_k x^k + \cdots + c_0$  that takes the map or matrix to zero ( $p$  is not the zero polynomial because the earlier observation includes that at least one of the coefficients is nonzero). From among all nonzero polynomials taking the map or matrix to zero, there must be at least one of minimal degree. Divide this  $p$  by  $c_k$  to get a leading one. Thus for any map or matrix a minimal polynomial exists.

We now show uniqueness. Suppose that  $m(x)$  and  $\hat{m}(x)$  both take the map or matrix to zero, are both of minimal degree and are thus of equal degree, and

both have a leading one. In their difference  $d(x) = m(x) - \hat{m}(x)$  the leading terms cancel. So  $d$  is of smaller degree than  $m$  and  $\hat{m}$ . If  $d$  were to have a leading coefficient that is nonzero then we could divide by it to get a polynomial that takes the map or matrix to zero and has leading coefficient one. This would contradict the choice of  $m$  and  $\hat{m}$  as of minimal degree. Thus the leading coefficient of  $d$  is zero, so  $m(x) - \hat{m}(x)$  is the zero polynomial, and so the two are equal. QED

**1.6 Example** We can see that  $m(x) = x^2 - 2x - 1$  is minimal for the matrix of Example 1.1 by computing the powers of  $T$  up to the power  $n^2 = 4$ .

$$T^2 = \begin{pmatrix} 1/2 & -\sqrt{3}/2 \\ \sqrt{3}/2 & 1/2 \end{pmatrix} \quad T^3 = \begin{pmatrix} 0 & -1 \\ 1 & 0 \end{pmatrix} \quad T^4 = \begin{pmatrix} -1/2 & -\sqrt{3}/2 \\ \sqrt{3}/2 & -1/2 \end{pmatrix}$$

Put  $c_4T^4 + c_3T^3 + c_2T^2 + c_1T + c_0I$  equal to the zero matrix

$$\begin{aligned} -(1/2)c_4 &+ (1/2)c_2 + (\sqrt{3}/2)c_1 + c_0 = 0 \\ -(\sqrt{3}/2)c_4 - c_3 - (\sqrt{3}/2)c_2 - (1/2)c_1 &= 0 \\ (\sqrt{3}/2)c_4 + c_3 + (\sqrt{3}/2)c_2 + (1/2)c_1 &= 0 \\ -(1/2)c_4 &+ (1/2)c_2 + (\sqrt{3}/2)c_1 + c_0 = 0 \end{aligned}$$

and use Gauss' method.

$$\begin{aligned} c_4 - c_2 - \sqrt{3}c_1 - 2c_0 &= 0 \\ c_3 + \sqrt{3}c_2 + 2c_1 + \sqrt{3}c_0 &= 0 \end{aligned}$$

Setting  $c_4$ ,  $c_3$ , and  $c_2$  to zero forces  $c_1$  and  $c_0$  to also come out as zero. To get a leading one, the most we can do is to set  $c_4$  and  $c_3$  to zero. Thus the minimal polynomial is quadratic.

Using the method of that example to find the minimal polynomial of a  $3 \times 3$  matrix would be tedious because it would mean doing Gaussian reduction on a system with nine equations in ten unknowns. We shall develop an alternative.

**1.7 Lemma** Suppose that the polynomial  $f(x) = c_n x^n + \cdots + c_1 x + c_0$  factors as  $k(x - \lambda_1)^{q_1} \cdots (x - \lambda_z)^{q_z}$ . If  $t$  is a linear transformation then these two are equal maps.

$$c_n t^n + \cdots + c_1 t + c_0 = k \cdot (t - \lambda_1 I)^{q_1} \circ \cdots \circ (t - \lambda_z I)^{q_z}$$

Consequently, if  $T$  is a square matrix then  $f(T)$  and  $k \cdot (T - \lambda_1 I)^{q_1} \cdots (T - \lambda_z I)^{q_z}$  are equal matrices.

**PROOF** We use induction on the degree of the polynomial. The cases where the polynomial is of degree zero and degree one are clear. The full induction argument is Exercise 1.7 but we will give its sense with the degree two case.

A quadratic polynomial factors into two linear terms  $f(x) = k(x - \lambda_1) \cdot (x - \lambda_2) = k(x^2 + (\lambda_1 + \lambda_2)x + \lambda_1\lambda_2)$  (the roots  $\lambda_1$  and  $\lambda_2$  could be equal). We can

check that substituting  $t$  for  $x$  in the factored and unfactored versions gives the same map.

$$\begin{aligned} (k \cdot (t - \lambda_1) \circ (t - \lambda_2))(\vec{v}) &= (k \cdot (t - \lambda_1))(t(\vec{v}) - \lambda_2\vec{v}) \\ &= k \cdot (t(t(\vec{v})) - t(\lambda_2\vec{v}) - \lambda_1 t(\vec{v}) - \lambda_1 \lambda_2 \vec{v}) \\ &= k \cdot (t \circ t(\vec{v}) - (\lambda_1 + \lambda_2)t(\vec{v}) + \lambda_1 \lambda_2 \vec{v}) \\ &= k \cdot (t^2 - (\lambda_1 + \lambda_2)t + \lambda_1 \lambda_2)(\vec{v}) \end{aligned}$$

The third equality holds because the scalar  $\lambda_2$  comes out of the second term, since  $t$  is linear. QED

In particular, if a minimal polynomial  $m(x)$  for a transformation  $t$  factors as  $m(x) = (x - \lambda_1)^{q_1} \cdots (x - \lambda_z)^{q_z}$  then  $m(t) = (t - \lambda_1)^{q_1} \circ \cdots \circ (t - \lambda_z)^{q_z}$  is the zero map. Since  $m(t)$  sends every vector to zero, at least one of the maps  $t - \lambda_i$  sends some nonzero vectors to zero. Exactly the same holds in the matrix case—if  $m$  is minimal for  $T$  then  $m(T) = (T - \lambda_1 I)^{q_1} \cdots (T - \lambda_z I)^{q_z}$  is the zero matrix and at least one of the matrices  $T - \lambda_i I$  sends some nonzero vectors to zero. That is, in both cases at least some of the  $\lambda_i$  are eigenvalues. (Exercise 29 expands on this.)

The next result is that every root of the minimal polynomial is an eigenvalue, and further that every eigenvalue is a root of the minimal polynomial (i.e. below it says ' $1 \leq q_i$ ' and not just ' $0 \leq q_i$ '). For that result, recall that to find eigenvalues we solve  $|T - xI| = 0$  and this determinant gives a polynomial in  $x$ , called the characteristic polynomial, whose roots are the eigenvalues.

**1.8 Theorem (Cayley-Hamilton)** If the characteristic polynomial of a transformation or square matrix factors into

$$k \cdot (x - \lambda_1)^{p_1} (x - \lambda_2)^{p_2} \cdots (x - \lambda_z)^{p_z}$$

then its minimal polynomial factors into

$$(x - \lambda_1)^{q_1} (x - \lambda_2)^{q_2} \cdots (x - \lambda_z)^{q_z}$$

where  $1 \leq q_i \leq p_i$  for each  $i$  between 1 and  $z$ .

The proof takes up the next three lemmas. We will state them in matrix terms but they apply equally well to maps. (The matrix version is convenient for the first proof.)

The first result is the key. For the proof, observe that we can view a matrix of polynomials as a polynomial with matrix coefficients.

$$\begin{pmatrix} 2x^2 + 3x - 1 & x^2 + 2 \\ 3x^2 + 4x + 1 & 4x^2 + x + 1 \end{pmatrix} = \begin{pmatrix} 2 & 1 \\ 3 & 4 \end{pmatrix} x^2 + \begin{pmatrix} 3 & 0 \\ 4 & 1 \end{pmatrix} x + \begin{pmatrix} -1 & 2 \\ 1 & 1 \end{pmatrix}$$

**1.9 Lemma** If  $T$  is a square matrix with characteristic polynomial  $c(x)$  then  $c(T)$  is the zero matrix.

**PROOF** Let  $C$  be  $T - \lambda I$ , the matrix whose determinant is the characteristic polynomial  $c(x) = c_n x^n + \cdots + c_1 x + c_0$ .

$$C = \begin{pmatrix} t_{1,1} - x & t_{1,2} & \cdots & & \\ & t_{2,1} & t_{2,2} - x & & \\ & \vdots & & \ddots & \\ & & & & t_{n,n} - x \end{pmatrix}$$

Recall Theorem Four.III.1.9, that the product of a matrix with its adjoint equals the determinant of the matrix times the identity.

$$c(x) \cdot I = \text{adj}(C)C = \text{adj}(C)(T - \lambda I) = \text{adj}(C)T - \text{adj}(C) \cdot x \quad (*)$$

The left side of  $(*)$  is  $c_n Ix^n + c_{n-1} Ix^{n-1} + \cdots + c_1 Ix + c_0 I$ . For the right side, the entries of  $\text{adj}(C)$  are polynomials, each of degree at most  $n - 1$  since the minors of a matrix drop a row and column. As suggested before the proof, rewrite it as a polynomial with matrix coefficients:  $\text{adj}(C) = C_{n-1}x^{n-1} + \cdots + C_1x + C_0$  where each  $C_i$  is a matrix of scalars. Now this is the right side of  $(*)$ .

$$[(C_{n-1}T)x^{n-1} + \cdots + (C_1T)x + C_0T] - [C_{n-1}x^n - C_{n-2}x^{n-1} - \cdots - C_0x]$$

Equate the left and right side of  $(*)$ 's coefficients of  $x^n$ , of  $x^{n-1}$ , etc.

$$\begin{aligned} c_n I &= -C_{n-1} \\ c_{n-1} I &= -C_{n-2} + C_{n-1}T \\ &\vdots \\ c_1 I &= -C_0 + C_1T \\ c_0 I &= C_0T \end{aligned}$$

Multiply, from the right, both sides of the first equation by  $T^n$ , both sides of the second equation by  $T^{n-1}$ , etc.

$$\begin{aligned} c_n T^n &= -C_{n-1}T^n \\ c_{n-1} T^{n-1} &= -C_{n-2}T^{n-1} + C_{n-1}T^n \\ &\vdots \\ c_1 T &= -C_0T + C_1T^2 \\ c_0 I &= C_0T \end{aligned}$$

Add. The left is  $c_n T^n + c_{n-1} T^{n-1} + \cdots + c_0 I$ . The right telescopes; for instance  $-C_{n-1}T^n$  from the first line combines with the  $+C_{n-1}T^n$  half of the second line, and the total on the right is the zero matrix. QED

We refer to that result by saying that a matrix or map *satisfies* its characteristic polynomial.

**1.10 Lemma** Where  $f(x)$  is a polynomial, if  $f(T)$  is the zero matrix then  $f(x)$  is divisible by the minimal polynomial of  $T$ . That is, any polynomial that is satisfied by  $T$  is divisible by  $T$ 's minimal polynomial.

**PROOF** Let  $m(x)$  be minimal for  $T$ . The Division Theorem for Polynomials gives  $f(x) = q(x)m(x) + r(x)$  where the degree of  $r$  is strictly less than the degree of  $m$ . Plugging in  $T$  shows that  $r(T)$  is the zero matrix, because  $T$  satisfies both  $f$  and  $m$ . That contradicts the minimality of  $m$  unless  $r$  is the zero polynomial. QED

Combining the prior two lemmas gives that the minimal polynomial divides the characteristic polynomial. Thus, any root of the minimal polynomial is also a root of the characteristic polynomial. That is, so far we have that if  $m(x) = (x - \lambda_1)^{q_1} \cdots (x - \lambda_i)^{q_i}$  then  $c(x)$  has the form  $(x - \lambda_1)^{p_1} \cdots (x - \lambda_i)^{p_i} (x - \lambda_{i+1})^{p_{i+1}} \cdots (x - \lambda_z)^{p_z}$  where each  $q_j$  is less than or equal to  $p_j$ . We finish the proof of the Cayley-Hamilton Theorem by showing that the characteristic polynomial has no additional roots, that is, there are no  $\lambda_{i+1}$ ,  $\lambda_{i+2}$ , etc.

**1.11 Lemma** Each linear factor of the characteristic polynomial of a square matrix is also a linear factor of the minimal polynomial.

**PROOF** Let  $T$  be a square matrix with minimal polynomial  $m(x)$  and assume that  $x - \lambda$  is a factor of the characteristic polynomial of  $T$ , that  $\lambda$  is an eigenvalue of  $T$ . We must show that  $x - \lambda$  is a factor of  $m$ , i.e., that  $m(\lambda) = 0$ .

Suppose that  $\lambda$  is an eigenvalue of  $T$  with associated eigenvector  $\vec{v}$ . Then  $T^2$  has the eigenvalue  $\lambda^2$  associated with  $\vec{v}$  because  $T \cdot T\vec{v} = T \cdot \lambda\vec{v} = \lambda T\vec{v} = \lambda^2\vec{v}$ . Similarly  $T^k$  has the eigenvalue  $\lambda^k$  associated with  $\vec{v}$ .

With that we have that for any polynomial function  $p(x)$ , application of the matrix  $p(T)$  to  $\vec{v}$  equals the result of multiplying  $\vec{v}$  by the scalar  $p(\lambda)$ .

$$\begin{aligned} p(T) \cdot \vec{v} &= (c_k T^k + \cdots + c_1 T + c_0 I) \cdot \vec{v} = c_k T^k \vec{v} + \cdots + c_1 T \vec{v} + c_0 \vec{v} \\ &= c_k \lambda^k \vec{v} + \cdots + c_1 \lambda \vec{v} + c_0 \vec{v} = p(\lambda) \cdot \vec{v} \end{aligned}$$

Since  $m(T)$  is the zero matrix,  $\vec{0} = m(T)(\vec{v}) = m(\lambda) \cdot \vec{v}$  for all  $\vec{v}$ , and hence  $m(\lambda) = 0$ . QED

That concludes the proof of the Cayley-Hamilton Theorem.

**1.12 Example** We can use the Cayley-Hamilton Theorem to find the minimal polynomial of this matrix.

$$T = \begin{pmatrix} 2 & 0 & 0 & 1 \\ 1 & 2 & 0 & 2 \\ 0 & 0 & 2 & -1 \\ 0 & 0 & 0 & 1 \end{pmatrix}$$



First we find its characteristic polynomial  $c(x) = (x-1)(x-2)^3$  with the usual determinant. Now the Cayley-Hamilton Theorem says that  $T$ 's minimal polynomial is either  $(x-1)(x-2)$  or  $(x-1)(x-2)^2$  or  $(x-1)(x-2)^3$ . We can decide among the choices just by computing

$$(T - 1I)(T - 2I) = \begin{pmatrix} 1 & 0 & 0 & 1 \\ 1 & 1 & 0 & 2 \\ 0 & 0 & 1 & -1 \\ 0 & 0 & 0 & 0 \end{pmatrix} \begin{pmatrix} 0 & 0 & 0 & 1 \\ 1 & 0 & 0 & 2 \\ 0 & 0 & 0 & -1 \\ 0 & 0 & 0 & -1 \end{pmatrix} = \begin{pmatrix} 0 & 0 & 0 & 0 \\ 1 & 0 & 0 & 1 \\ 0 & 0 & 0 & 0 \\ 0 & 0 & 0 & 0 \end{pmatrix}$$

and

$$(T - 1I)(T - 2I)^2 = \begin{pmatrix} 0 & 0 & 0 & 0 \\ 1 & 0 & 0 & 1 \\ 0 & 0 & 0 & 0 \\ 0 & 0 & 0 & 0 \end{pmatrix} \begin{pmatrix} 0 & 0 & 0 & 1 \\ 1 & 0 & 0 & 2 \\ 0 & 0 & 0 & -1 \\ 0 & 0 & 0 & -1 \end{pmatrix} = \begin{pmatrix} 0 & 0 & 0 & 0 \\ 0 & 0 & 0 & 0 \\ 0 & 0 & 0 & 0 \\ 0 & 0 & 0 & 0 \end{pmatrix}$$

and so  $m(x) = (x-1)(x-2)^2$ .

### Exercises

- ✓ **1.13** What are the possible minimal polynomials if a matrix has the given characteristic polynomial?

(a)  $8 \cdot (x-3)^4$     (b)  $(1/3) \cdot (x+1)^3(x-4)$     (c)  $-1 \cdot (x-2)^2(x-5)^2$   
 (d)  $5 \cdot (x+3)^2(x-1)(x-2)^2$

What is the degree of each possibility?

- ✓ **1.14** Find the minimal polynomial of each matrix.

(a)  $\begin{pmatrix} 3 & 0 & 0 \\ 1 & 3 & 0 \\ 0 & 0 & 4 \end{pmatrix}$     (b)  $\begin{pmatrix} 3 & 0 & 0 \\ 1 & 3 & 0 \\ 0 & 0 & 3 \end{pmatrix}$     (c)  $\begin{pmatrix} 3 & 0 & 0 \\ 1 & 3 & 0 \\ 0 & 1 & 3 \end{pmatrix}$     (d)  $\begin{pmatrix} 2 & 0 & 1 \\ 0 & 6 & 2 \\ 0 & 0 & 2 \end{pmatrix}$   
 (e)  $\begin{pmatrix} 2 & 2 & 1 \\ 0 & 6 & 2 \\ 0 & 0 & 2 \end{pmatrix}$     (f)  $\begin{pmatrix} -1 & 4 & 0 & 0 & 0 \\ 0 & 3 & 0 & 0 & 0 \\ 0 & -4 & -1 & 0 & 0 \\ 3 & -9 & -4 & 2 & -1 \\ 1 & 5 & 4 & 1 & 4 \end{pmatrix}$

- 1.15** Find the minimal polynomial of this matrix.

$$\begin{pmatrix} 0 & 1 & 0 \\ 0 & 0 & 1 \\ 1 & 0 & 0 \end{pmatrix}$$

- ✓ **1.16** What is the minimal polynomial of the differentiation operator  $d/dx$  on  $\mathcal{P}_n$ ?

- ✓ **1.17** Find the minimal polynomial of matrices of this form

$$\begin{pmatrix} \lambda & 0 & 0 & \dots & 0 \\ 1 & \lambda & 0 & & 0 \\ 0 & 1 & \lambda & & \\ & & & \ddots & \\ & & & & \lambda & 0 \\ 0 & 0 & \dots & & 1 & \lambda \end{pmatrix}$$

where the scalar  $\lambda$  is fixed (i.e., is not a variable).

- 1.18 What is the minimal polynomial of the transformation of  $\mathcal{P}_n$  that sends  $p(x)$  to  $p(x+1)$ ?
- 1.19 What is the minimal polynomial of the map  $\pi: \mathbb{C}^3 \rightarrow \mathbb{C}^3$  projecting onto the first two coordinates?
- 1.20 Find a  $3 \times 3$  matrix whose minimal polynomial is  $x^2$ .
- 1.21 What is wrong with this claimed proof of Lemma 1.9: “if  $c(x) = |T - xI|$  then  $c(T) = |T - TI| = 0$ ”? [Cullen]
- 1.22 Verify Lemma 1.9 for  $2 \times 2$  matrices by direct calculation.
- ✓ 1.23 Prove that the minimal polynomial of an  $n \times n$  matrix has degree at most  $n$  (not  $n^2$  as a person might guess from this subsection’s opening). Verify that this maximum,  $n$ , can happen.
- ✓ 1.24 Show that, on a nontrivial vector space, a linear transformation is nilpotent if and only if its only eigenvalue is zero.
- 1.25 What is the minimal polynomial of a zero map or matrix? Of an identity map or matrix?
- ✓ 1.26 Interpret the minimal polynomial of Example 1.1 geometrically.
- 1.27 What is the minimal polynomial of a diagonal matrix?
- ✓ 1.28 A *projection* is any transformation  $t$  such that  $t^2 = t$ . (For instance, consider the transformation of the plane  $\mathbb{R}^2$  projecting each vector onto its first coordinate. If we project twice then we get the same result as if we project just once.) What is the minimal polynomial of a projection?
- 1.29 *The first two items of this question are review.*
- (a) Prove that the composition of one-to-one maps is one-to-one.
- (b) Prove that if a linear map is not one-to-one then at least one nonzero vector from the domain maps to the zero vector in the codomain.
- (c) Verify the statement, excerpted here, that precedes Theorem 1.8.
- ... if a minimal polynomial  $m(x)$  for a transformation  $t$  factors as  $m(x) = (x - \lambda_1)^{q_1} \cdots (x - \lambda_z)^{q_z}$  then  $m(t) = (t - \lambda_1)^{q_1} \circ \cdots \circ (t - \lambda_z)^{q_z}$  is the zero map. Since  $m(t)$  sends every vector to zero, at least one of the maps  $t - \lambda_i$  sends some nonzero vectors to zero. ... That is, ... at least some of the  $\lambda_i$  are eigenvalues.
- 1.30 True or false: for a transformation on an  $n$  dimensional space, if the minimal polynomial has degree  $n$  then the map is diagonalizable.
- 1.31 Let  $f(x)$  be a polynomial. Prove that if  $A$  and  $B$  are similar matrices then  $f(A)$  is similar to  $f(B)$ .
- (a) Now show that similar matrices have the same characteristic polynomial.
- (b) Show that similar matrices have the same minimal polynomial.
- (c) Decide if these are similar.
- $$\begin{pmatrix} 1 & 3 \\ 2 & 3 \end{pmatrix} \quad \begin{pmatrix} 4 & -1 \\ 1 & 1 \end{pmatrix}$$
- 1.32 (a) Show that a matrix is invertible if and only if the constant term in its minimal polynomial is not 0.
- (b) Show that if a square matrix  $T$  is not invertible then there is a nonzero matrix  $S$  such that  $ST$  and  $TS$  both equal the zero matrix.
- ✓ 1.33 (a) Finish the proof of Lemma 1.7.
- (b) Give an example to show that the result does not hold if  $t$  is not linear.
- 1.34 Any transformation or square matrix has a minimal polynomial. Does the converse hold?

## IV.2 Jordan Canonical Form

We are looking for a canonical form for matrix similarity. This subsection completes this program by moving from the canonical form for the classes of nilpotent matrices to the canonical form for all classes.

**2.1 Lemma** A linear transformation on a nontrivial vector space is nilpotent if and only if its only eigenvalue is zero.

**PROOF** Let the linear transformation be  $t: V \rightarrow V$ . If  $t$  is nilpotent then there is an  $n$  such that  $t^n$  is the zero map, so  $t$  satisfies the polynomial  $p(x) = x^n = (x - 0)^n$ . By Lemma 1.10 the minimal polynomial of  $t$  divides  $p$ , so the minimal polynomial has only zero for a root. By Cayley-Hamilton, Theorem 1.8, the characteristic polynomial has only zero for a root. Thus the only eigenvalue of  $t$  is zero.

Conversely, if a transformation  $t$  on an  $n$ -dimensional space has only the single eigenvalue of zero then its characteristic polynomial is  $x^n$ . Lemma 1.9 says that a map satisfies its characteristic polynomial so  $t^n$  is the zero map. Thus  $t$  is nilpotent. QED

The phrase “nontrivial vector space” is there because on a trivial space  $\{\vec{0}\}$  the only transformation is the zero map, which has no eigenvalues because there are no associated nonzero eigenvectors.

**2.2 Corollary** The transformation  $t - \lambda$  is nilpotent if and only if  $t$ 's only eigenvalue is  $\lambda$ .

**PROOF** The transformation  $t - \lambda$  is nilpotent if and only if  $t - \lambda$ 's only eigenvalue is 0. That holds if and only if  $t$ 's only eigenvalue is  $\lambda$ , because  $t(\vec{v}) = \lambda\vec{v}$  if and only if  $(t - \lambda)(\vec{v}) = 0 \cdot \vec{v}$ . QED

We already have the canonical form that we want for the case of nilpotent matrices, that is, for each matrix whose only eigenvalue is zero. Corollary III.2.15 says that each such matrix is similar to one that is all zeroes except for blocks of subdiagonal ones.

**2.3 Lemma** If the matrices  $T - \lambda I$  and  $N$  are similar then  $T$  and  $N + \lambda I$  are also similar, via the same change of basis matrices.

**PROOF** With  $N = P(T - \lambda I)P^{-1} = PTP^{-1} - P(\lambda I)P^{-1}$  we have  $N = PTP^{-1} - PP^{-1}(\lambda I)$  since the diagonal matrix  $\lambda I$  commutes with anything, and so  $N = PTP^{-1} - \lambda I$ . Therefore  $N + \lambda I = PTP^{-1}$ . QED

**2.4 Example** The characteristic polynomial of

$$T = \begin{pmatrix} 2 & -1 \\ 1 & 4 \end{pmatrix}$$

is  $(x - 3)^2$  and so  $T$  has only the single eigenvalue 3. Thus for

$$T - 3I = \begin{pmatrix} -1 & -1 \\ 1 & 1 \end{pmatrix}$$

the only eigenvalue is 0 and  $T - 3I$  is nilpotent. Finding the nullspaces is routine; to ease this computation we take  $T$  to represent a transformation  $t: \mathbb{C}^2 \rightarrow \mathbb{C}^2$  with respect to the standard basis (we shall do this for the rest of the chapter).

$$\mathcal{N}(t - 3) = \left\{ \begin{pmatrix} -y \\ y \end{pmatrix} \mid y \in \mathbb{C} \right\} \quad \mathcal{N}((t - 3)^2) = \mathbb{C}^2$$

The dimensions of these nullspaces show that the action of the map  $t - 3$  on a string basis is  $\vec{\beta}_1 \mapsto \vec{\beta}_2 \mapsto \vec{0}$ . Thus, here is the canonical form for  $t - 3$  with one choice for a string basis.

$$\text{Rep}_{B,B}(t - 3) = N = \begin{pmatrix} 0 & 0 \\ 1 & 0 \end{pmatrix} \quad B = \left\langle \begin{pmatrix} 1 \\ 1 \end{pmatrix}, \begin{pmatrix} -2 \\ 2 \end{pmatrix} \right\rangle$$

By Lemma 2.3,  $T$  is similar to this matrix.

$$\text{Rep}_{B,B}(t) = N + 3I = \begin{pmatrix} 3 & 0 \\ 1 & 3 \end{pmatrix}$$

We can produce the similarity computation. Recall how to find the change of basis matrices  $P$  and  $P^{-1}$  to express  $N$  as  $P(T - 3I)P^{-1}$ . The similarity diagram

$$\begin{array}{ccc} \mathbb{C}_{\text{wrt } \mathcal{E}_2}^2 & \xrightarrow[T-3I]{t-3} & \mathbb{C}_{\text{wrt } \mathcal{E}_2}^2 \\ \text{id} \downarrow P & & \text{id} \downarrow P \\ \mathbb{C}_{\text{wrt } B}^2 & \xrightarrow[N]{t-3} & \mathbb{C}_{\text{wrt } B}^2 \end{array}$$

describes that to move from the lower left to the upper left we multiply by

$$P^{-1} = (\text{Rep}_{\mathcal{E}_2, B}(\text{id}))^{-1} = \text{Rep}_{B, \mathcal{E}_2}(\text{id}) = \begin{pmatrix} 1 & -2 \\ 1 & 2 \end{pmatrix}$$

and to move from the upper right to the lower right we multiply by this matrix.

$$P = \begin{pmatrix} 1 & -2 \\ 1 & 2 \end{pmatrix}^{-1} = \begin{pmatrix} 1/2 & 1/2 \\ -1/4 & 1/4 \end{pmatrix}$$

So this equation expresses the similarity.

$$\begin{pmatrix} 3 & 0 \\ 1 & 3 \end{pmatrix} = \begin{pmatrix} 1/2 & 1/2 \\ -1/4 & 1/4 \end{pmatrix} \begin{pmatrix} 2 & -1 \\ 1 & 4 \end{pmatrix} \begin{pmatrix} 1 & -2 \\ 1 & 2 \end{pmatrix}$$

**2.5 Example** This matrix has characteristic polynomial  $(x - 4)^4$

$$T = \begin{pmatrix} 4 & 1 & 0 & -1 \\ 0 & 3 & 0 & 1 \\ 0 & 0 & 4 & 0 \\ 1 & 0 & 0 & 5 \end{pmatrix}$$

and so has the single eigenvalue 4. The nullities are: the nullspace of  $t - 4$  has dimension two, the nullspace of  $(t - 4)^2$  has dimension three, and the nullspace of  $(t - 4)^3$  has dimension four. Thus,  $t - 4$  has the action on a string basis of  $\vec{\beta}_1 \mapsto \vec{\beta}_2 \mapsto \vec{\beta}_3 \mapsto \vec{0}$  and  $\vec{\beta}_4 \mapsto \vec{0}$ . This gives the canonical form  $N$  for  $t - 4$ , which in turn gives the form for  $t$ .

$$N + 4I = \begin{pmatrix} 4 & 0 & 0 & 0 \\ 1 & 4 & 0 & 0 \\ 0 & 1 & 4 & 0 \\ 0 & 0 & 0 & 4 \end{pmatrix}$$

An array that is all zeroes, except for some number  $\lambda$  down the diagonal and blocks of subdiagonal ones, is a *Jordan block*. We have shown that Jordan block matrices are canonical representatives of the similarity classes of single-eigenvalue matrices.

**2.6 Example** The  $3 \times 3$  matrices whose only eigenvalue is  $1/2$  separate into three similarity classes. The three classes have these canonical representatives.

$$\begin{pmatrix} 1/2 & 0 & 0 \\ 0 & 1/2 & 0 \\ 0 & 0 & 1/2 \end{pmatrix} \quad \begin{pmatrix} 1/2 & 0 & 0 \\ 1 & 1/2 & 0 \\ 0 & 0 & 1/2 \end{pmatrix} \quad \begin{pmatrix} 1/2 & 0 & 0 \\ 1 & 1/2 & 0 \\ 0 & 1 & 1/2 \end{pmatrix}$$

In particular, this matrix

$$\begin{pmatrix} 1/2 & 0 & 0 \\ 0 & 1/2 & 0 \\ 0 & 1 & 1/2 \end{pmatrix}$$

belongs to the similarity class represented by the middle one, because we have adopted the convention of ordering the blocks of subdiagonal ones from the longest block to the shortest.

We will now finish the program of this chapter by extending this work to cover maps and matrices with multiple eigenvalues. The best possibility for general maps and matrices would be if we could break them into a part involving their first eigenvalue  $\lambda_1$  (which we represent using its Jordan block), a part with  $\lambda_2$ , etc.

This best possibility is what happens. For any transformation  $t: V \rightarrow V$ , we shall break the space  $V$  into the direct sum of a part on which  $t - \lambda_1$  is nilpotent, a part on which  $t - \lambda_2$  is nilpotent, etc.

Suppose that  $t: V \rightarrow V$  is a linear transformation. The restriction\* of  $t$  to a subspace  $M$  need not be a linear transformation on  $M$  because there may be an

\* More information on restrictions of functions is in the appendix.

$\vec{m} \in M$  with  $t(\vec{m}) \notin M$  (for instance, the transformation that rotates the plane by a quarter turn does not map most members of the  $x = y$  line subspace back within that subspace). To ensure that the restriction of a transformation to a part of a space is a transformation on the part we need the next condition.

**2.7 Definition** Let  $t: V \rightarrow V$  be a transformation. A subspace  $M$  is *t invariant* if whenever  $\vec{m} \in M$  then  $t(\vec{m}) \in M$  (shorter:  $t(M) \subseteq M$ ).

Recall that Lemma III.1.4 shows that for any transformation  $t$  on an  $n$  dimensional space the rangespaces of iterates are stable

$$\mathcal{R}(t^n) = \mathcal{R}(t^{n+1}) = \dots = \mathcal{R}_\infty(t)$$

as are the nullspaces.

$$\mathcal{N}(t^n) = \mathcal{N}(t^{n+1}) = \dots = \mathcal{N}_\infty(t)$$

Thus, the generalized nullspace  $\mathcal{N}_\infty(t)$  and the generalized rangespace  $\mathcal{R}_\infty(t)$  are  $t$  invariant. In particular,  $\mathcal{N}_\infty(t - \lambda_i)$  and  $\mathcal{R}_\infty(t - \lambda_i)$  are  $t - \lambda_i$  invariant.

The action of the transformation  $t - \lambda_i$  on  $\mathcal{N}_\infty(t - \lambda_i)$  is especially easy to understand. Observe that any transformation  $t$  is nilpotent on  $\mathcal{N}_\infty(t)$ , because if  $\vec{v} \in \mathcal{N}_\infty(t)$  then by definition  $t^n(\vec{v}) = \vec{0}$ . Thus  $t - \lambda_i$  is nilpotent on  $\mathcal{N}_\infty(t - \lambda_i)$ .

We shall take three steps to prove this section's major result. The next result is the first.

**2.8 Lemma** A subspace is  $t$  invariant if and only if it is  $t - \lambda$  invariant for all scalars  $\lambda$ . In particular, if  $\lambda_i$  is an eigenvalue of a linear transformation  $t$  then for any other eigenvalue  $\lambda_j$  the spaces  $\mathcal{N}_\infty(t - \lambda_i)$  and  $\mathcal{R}_\infty(t - \lambda_i)$  are  $t - \lambda_j$  invariant.

**PROOF** For the first sentence we check the two implications separately. The 'if' half is easy: if the subspace is  $t - \lambda$  invariant for all scalars  $\lambda$  then using  $\lambda = 0$  shows that it is  $t$  invariant. For 'only if' suppose that the subspace is  $t$  invariant, so that if  $\vec{m} \in M$  then  $t(\vec{m}) \in M$ , and let  $\lambda$  be a scalar. The subspace  $M$  is closed under linear combinations and so if  $t(\vec{m}) \in M$  then  $t(\vec{m}) - \lambda\vec{m} \in M$ . Thus if  $\vec{m} \in M$  then  $(t - \lambda)(\vec{m}) \in M$ .

The second sentence follows from the first. The two spaces are  $t - \lambda_i$  invariant so they are  $t$  invariant. Apply the first sentence again to conclude that they are also  $t - \lambda_j$  invariant. QED

The second step of the three that we will take to prove this section's major result makes use of an additional property of  $\mathcal{N}_\infty(t - \lambda_i)$  and  $\mathcal{R}_\infty(t - \lambda_i)$ , that they are complementary. Recall that if a space is the direct sum of two others  $V = \mathcal{N} \oplus \mathcal{R}$  then any vector  $\vec{v}$  in the space breaks into two parts  $\vec{v} = \vec{n} + \vec{r}$  where  $\vec{n} \in \mathcal{N}$  and  $\vec{r} \in \mathcal{R}$ , and recall also that if  $B_{\mathcal{N}}$  and  $B_{\mathcal{R}}$  are bases for  $\mathcal{N}$  and  $\mathcal{R}$  then the concatenation  $B_{\mathcal{N}} \widehat{\ } B_{\mathcal{R}}$  is linearly independent (and so the two parts of  $\vec{v}$  do not "overlap"). The next result says that for any subspaces  $\mathcal{N}$  and

$\mathcal{R}$  that are complementary as well as  $t$  invariant, the action of  $t$  on  $\vec{v}$  breaks into the “non-overlapping” actions of  $t$  on  $\vec{n}$  and on  $\vec{r}$ .

**2.9 Lemma** Let  $t: V \rightarrow V$  be a transformation and let  $\mathcal{N}$  and  $\mathcal{R}$  be  $t$  invariant complementary subspaces of  $V$ . Then we can represent  $t$  by a matrix with blocks of square submatrices  $T_1$  and  $T_2$

$$\left( \begin{array}{c|c} T_1 & Z_2 \\ \hline Z_1 & T_2 \end{array} \right) \begin{array}{l} \dim(\mathcal{N})\text{-many rows} \\ \dim(\mathcal{R})\text{-many rows} \end{array}$$

where  $Z_1$  and  $Z_2$  are blocks of zeroes.

**PROOF** Since the two subspaces are complementary, the concatenation of a basis for  $\mathcal{N}$  and a basis for  $\mathcal{R}$  makes a basis  $B = \langle \vec{v}_1, \dots, \vec{v}_p, \vec{\mu}_1, \dots, \vec{\mu}_q \rangle$  for  $V$ . We shall show that the matrix

$$\text{Rep}_{B,B}(t) = \begin{pmatrix} \vdots & & \vdots \\ \text{Rep}_B(t(\vec{v}_1)) & \cdots & \text{Rep}_B(t(\vec{\mu}_q)) \\ \vdots & & \vdots \end{pmatrix}$$

has the desired form.

Any vector  $\vec{v} \in V$  is a member of  $\mathcal{N}$  if and only if when it is represented with respect to  $B$  its final  $q$  coefficients are zero. As  $\mathcal{N}$  is  $t$  invariant, each of the vectors  $\text{Rep}_B(t(\vec{v}_1)), \dots, \text{Rep}_B(t(\vec{v}_p))$  has this form. Hence the lower left of  $\text{Rep}_{B,B}(t)$  is all zeroes. The argument for the upper right is similar. QED

To see that we have decomposed  $t$  into its action on the parts, let  $B_{\mathcal{N}} = \langle \vec{v}_1, \dots, \vec{v}_p \rangle$  and  $B_{\mathcal{R}} = \langle \vec{\mu}_1, \dots, \vec{\mu}_q \rangle$ . Observe that the restrictions of  $t$  to the subspaces  $\mathcal{N}$  and  $\mathcal{R}$  are represented with respect to the bases  $B_{\mathcal{N}}, B_{\mathcal{N}}$  and  $B_{\mathcal{R}}, B_{\mathcal{R}}$  by the matrices  $T_1$  and  $T_2$ . So with subspaces that are invariant and complementary we can split the problem of examining a linear transformation into two lower-dimensional subproblems. The next result illustrates this decomposition into blocks.

**2.10 Lemma** If  $T$  is a matrix with square submatrices  $T_1$  and  $T_2$

$$T = \left( \begin{array}{c|c} T_1 & Z_2 \\ \hline Z_1 & T_2 \end{array} \right)$$

where the  $Z$ 's are blocks of zeroes, then  $|T| = |T_1| \cdot |T_2|$ .

**PROOF** Suppose that  $T$  is  $n \times n$ , that  $T_1$  is  $p \times p$ , and that  $T_2$  is  $q \times q$ . In the permutation formula for the determinant

$$|T| = \sum_{\text{permutations } \phi} t_{1,\phi(1)} t_{2,\phi(2)} \cdots t_{n,\phi(n)} \text{sgn}(\phi)$$

each term comes from a rearrangement of the column numbers  $1, \dots, n$  into a new order  $\phi(1), \dots, \phi(n)$ . The upper right block  $Z_2$  is all zeroes, so if a  $\phi$  has at least one of  $p+1, \dots, n$  among its first  $p$  column numbers  $\phi(1), \dots, \phi(p)$  then the term arising from  $\phi$  does not contribute to the sum because it is zero, e.g., if  $\phi(1) = n$  then  $t_{1,\phi(1)}t_{2,\phi(2)} \cdots t_{n,\phi(n)} = 0 \cdot t_{2,\phi(2)} \cdots t_{n,\phi(n)} = 0$ .

So the above formula reduces to a sum over all permutations with two halves: any contributing  $\phi$  is the composition of a  $\phi_1$  that rearranges only  $1, \dots, p$  and a  $\phi_2$  that rearranges only  $p+1, \dots, p+q$ . Now, the distributive law and the fact that the signum of a composition is the product of the signums gives that this

$$|T_1| \cdot |T_2| = \left( \sum_{\substack{\text{perms } \phi_1 \\ \text{of } 1, \dots, p}} t_{1,\phi_1(1)} \cdots t_{p,\phi_1(p)} \operatorname{sgn}(\phi_1) \right) \cdot \left( \sum_{\substack{\text{perms } \phi_2 \\ \text{of } p+1, \dots, p+q}} t_{p+1,\phi_2(p+1)} \cdots t_{p+q,\phi_2(p+q)} \operatorname{sgn}(\phi_2) \right)$$

equals  $|T| = \sum_{\text{contributing } \phi} t_{1,\phi(1)} t_{2,\phi(2)} \cdots t_{n,\phi(n)} \operatorname{sgn}(\phi)$ .

QED

### 2.11 Example

$$\begin{vmatrix} 2 & 0 & 0 & 0 \\ 1 & 2 & 0 & 0 \\ 0 & 0 & 3 & 0 \\ 0 & 0 & 0 & 3 \end{vmatrix} = \begin{vmatrix} 2 & 0 \\ 1 & 2 \end{vmatrix} \cdot \begin{vmatrix} 3 & 0 \\ 0 & 3 \end{vmatrix} = 36$$

From Lemma 2.10 we conclude that if two subspaces are complementary and  $t$  invariant then  $t$  is one-to-one if and only if its restriction to each subspace is nonsingular.

Now for the promised third, and final, step to the main result.

**2.12 Lemma** If a linear transformation  $t: V \rightarrow V$  has the characteristic polynomial  $(x - \lambda_1)^{p_1} \cdots (x - \lambda_j)^{p_j}$  then (1)  $V = \mathcal{N}_\infty(t - \lambda_1) \oplus \cdots \oplus \mathcal{N}_\infty(t - \lambda_j)$  and (2)  $\dim(\mathcal{N}_\infty(t - \lambda_i)) = p_i$ .

**PROOF** We start by proving that  $\mathcal{N}_\infty(t - \lambda_i) \cap \mathcal{N}_\infty(t - \lambda_j) = \{\vec{0}\}$  when  $i \neq j$ . This shows that the bases for the generalized nullspaces, when concatenated, form a linearly independent subset of the space  $V$ . We will then show that clause (2) holds because with that, since the degree  $p_1 + \cdots + p_k$  of the characteristic polynomial equals the dimension of the space  $V$ , we will have proved clause (1) also.

So consider  $\mathcal{N}_\infty(t - \lambda_i) \cap \mathcal{N}_\infty(t - \lambda_j)$  when  $i \neq j$ . By Lemma 2.8 both  $\mathcal{N}_\infty(t - \lambda_i)$  and  $\mathcal{N}_\infty(t - \lambda_j)$  are  $t$  invariant. The intersection of  $t$  invariant subspaces is  $t$  invariant and so the restriction of  $t$  to  $\mathcal{N}_\infty(t - \lambda_i) \cap \mathcal{N}_\infty(t - \lambda_j)$  is a linear transformation. Now,  $t - \lambda_i$  is nilpotent on  $\mathcal{N}_\infty(t - \lambda_i)$  and  $t - \lambda_j$  is nilpotent on  $\mathcal{N}_\infty(t - \lambda_j)$ , so both  $t - \lambda_i$  and  $t - \lambda_j$  are nilpotent on the intersection. Therefore by Lemma 2.1 and the observation following it, if  $t$  has



any eigenvalues on the intersection then the “only” eigenvalue is both  $\lambda_i$  and  $\lambda_j$ . This cannot be, so the restriction has no eigenvalues:  $\mathcal{N}_\infty(t - \lambda_i) \cap \mathcal{N}_\infty(t - \lambda_j)$  is the trivial space (Lemma 3.12 shows that the only transformation that is without any eigenvalues is the transformation on the trivial space).

To prove clause (2), decompose  $V$  as  $\mathcal{N}_\infty(t - \lambda_i) \oplus \mathcal{R}_\infty(t - \lambda_i)$  and apply Lemma 2.9.

$$T = \left( \begin{array}{c|c} T_1 & Z_2 \\ \hline Z_1 & T_2 \end{array} \right) \begin{array}{l} \dim(\mathcal{N}_\infty(t - \lambda_i))\text{-many rows} \\ \dim(\mathcal{R}_\infty(t - \lambda_i))\text{-many rows} \end{array}$$

Lemma 2.10 says that  $|T - xI| = |T_1 - xI| \cdot |T_2 - xI|$ . By the uniqueness clause of the Fundamental Theorem of Algebra, the determinants of the blocks have the same factors as the characteristic polynomial  $|T_1 - xI| = (x - \lambda_1)^{q_1} \cdots (x - \lambda_z)^{q_z}$  and  $|T_2 - xI| = (x - \lambda_1)^{r_1} \cdots (x - \lambda_z)^{r_z}$ , where  $q_1 + r_1 = p_1, \dots, q_z + r_z = p_z$ . Theorem I.1.11. We will finish by establishing that (i)  $q_j = 0$  for all  $j \neq i$ , and (ii)  $q_i = p_i$ . Together these prove clause (2) because they show that the degree of the polynomial  $|T_1 - xI|$  is  $q_i$ , and the degree of that polynomial equals the dimension of the generalized nullspace  $\mathcal{N}_\infty(t - \lambda_i)$ .

For (i), because the restriction of  $t - \lambda_i$  to  $\mathcal{N}_\infty(t - \lambda_i)$  is nilpotent on that space,  $t$ 's only eigenvalue on that space is  $\lambda_i$ , by Lemma 2.2. So  $q_j = 0$  for  $j \neq i$ .

For (ii), consider the restriction of  $t$  to  $\mathcal{R}_\infty(t - \lambda_i)$ . By Lemma III.2.1, the map  $t - \lambda_i$  is one-to-one on  $\mathcal{R}_\infty(t - \lambda_i)$  and so  $\lambda_i$  is not an eigenvalue of  $t$  on that subspace. Therefore  $x - \lambda_i$  is not a factor of  $|T_2 - xI|$ , so  $r_i = 0$ , and so  $q_i = p_i$ . QED

Recall the goal of this chapter, to give a canonical form for matrix similarity. That result is next. It translates the above steps into matrix terms.

**2.13 Theorem** Any square matrix is similar to one in *Jordan form*

$$\left( \begin{array}{cccc} J_{\lambda_1} & \text{--zeroes--} & & \\ & J_{\lambda_2} & & \\ & & \ddots & \\ & & & J_{\lambda_{k-1}} \\ \text{--zeroes--} & & & J_{\lambda_k} \end{array} \right)$$

where each  $J_\lambda$  is the Jordan block associated with an eigenvalue  $\lambda$  of the original matrix (that is, is all zeroes except for  $\lambda$ 's down the diagonal and some subdiagonal ones).

**PROOF** Given an  $n \times n$  matrix  $T$ , consider the linear map  $t: \mathbb{C}^n \rightarrow \mathbb{C}^n$  that it represents with respect to the standard bases. Use the prior lemma to write  $\mathbb{C}^n = \mathcal{N}_\infty(t - \lambda_1) \oplus \cdots \oplus \mathcal{N}_\infty(t - \lambda_z)$  where  $\lambda_1, \dots, \lambda_z$  are the eigenvalues of  $t$ . Because each  $\mathcal{N}_\infty(t - \lambda_i)$  is  $t$  invariant, Lemma 2.9 and the prior lemma show that  $t$  is represented by a matrix that is all zeroes except for square blocks along the diagonal. To make those blocks into Jordan blocks, pick each  $B_{\lambda_i}$  to be a string basis for the action of  $t - \lambda_i$  on  $\mathcal{N}_\infty(t - \lambda_i)$ . QED

**2.14 Corollary** Every square matrix is similar to the sum of a diagonal matrix and a nilpotent matrix.

Strictly speaking, to make Jordan form a canonical form for matrix similarity classes it must be unique. That is, for any square matrix there needs to be one and only one matrix  $J$  similar to it and of the specified form. As we have stated it, the theorem allows us to rearrange the Jordan blocks. We could make this form unique, say by arranging the Jordan blocks from the least eigenvalue to greatest and arranging the blocks of subdiagonal ones inside each Jordan block from longest to shortest.

**2.15 Example** This matrix has the characteristic polynomial  $(x - 2)^2(x - 6)$ .

$$T = \begin{pmatrix} 2 & 0 & 1 \\ 0 & 6 & 2 \\ 0 & 0 & 2 \end{pmatrix}$$

We will handle the eigenvalues 2 and 6 separately.

First the eigenvalue 2. Computation of the powers of  $T - 2I$ , and of the nullspaces and nullities, is routine. (Recall from Example 2.4 our convention of taking  $T$  to represent a transformation  $t: \mathbb{C}^3 \rightarrow \mathbb{C}^3$  with respect to the standard basis.)

$p$	$(T - 2I)^p$	$\mathcal{N}((t - 2)^p)$	<i>nullity</i>
1	$\begin{pmatrix} 0 & 0 & 1 \\ 0 & 4 & 2 \\ 0 & 0 & 0 \end{pmatrix}$	$\left\{ \begin{pmatrix} x \\ 0 \\ 0 \end{pmatrix} \mid x \in \mathbb{C} \right\}$	1
2	$\begin{pmatrix} 0 & 0 & 0 \\ 0 & 16 & 8 \\ 0 & 0 & 0 \end{pmatrix}$	$\left\{ \begin{pmatrix} x \\ -z/2 \\ z \end{pmatrix} \mid x, z \in \mathbb{C} \right\}$	2
3	$\begin{pmatrix} 0 & 0 & 0 \\ 0 & 64 & 32 \\ 0 & 0 & 0 \end{pmatrix}$	-same-	-same-

So the generalized nullspace  $\mathcal{N}_\infty(t - 2)$  has dimension two. We know that the restriction of  $t - 2$  is nilpotent on this subspace. From the way that the nullities grow we know that the action of  $t - 2$  on a string basis is  $\vec{\beta}_1 \mapsto \vec{\beta}_2 \mapsto \vec{0}$ . Thus we can represent the restriction in the canonical form

$$N_2 = \begin{pmatrix} 0 & 0 \\ 1 & 0 \end{pmatrix} = \text{Rep}_{B,B}(t - 2) \quad B_2 = \left\langle \begin{pmatrix} 1 \\ 1 \\ -2 \end{pmatrix}, \begin{pmatrix} -2 \\ 0 \\ 0 \end{pmatrix} \right\rangle$$

(other choices of basis are possible). Consequently, the action of the restriction of  $t$  to  $\mathcal{N}_\infty(t - 2)$  is represented by this matrix.

$$J_2 = N_2 + 2I = \text{Rep}_{B_2, B_2}(t) = \begin{pmatrix} 2 & 0 \\ 1 & 2 \end{pmatrix}$$

The second eigenvalue's computations are easier. Because the power of  $x - 6$  in the characteristic polynomial is one, the restriction of  $t - 6$  to  $\mathcal{N}_\infty(t - 6)$  must be nilpotent of index one. Its action on a string basis must be  $\vec{\beta}_3 \mapsto \vec{0}$  and since it is the zero map, its canonical form  $N_6$  is the  $1 \times 1$  zero matrix. Consequently, the canonical form  $J_6$  for the action of  $t$  on  $\mathcal{N}_\infty(t - 6)$  is the  $1 \times 1$  matrix with the single entry 6. For the basis we can use any nonzero vector from the generalized nullspace.

$$B_6 = \left\langle \begin{pmatrix} 0 \\ 1 \\ 0 \end{pmatrix} \right\rangle$$

Taken together, these two give that the Jordan form of  $T$  is

$$\text{Rep}_{B, B}(t) = \begin{pmatrix} 2 & 0 & 0 \\ 1 & 2 & 0 \\ 0 & 0 & 6 \end{pmatrix}$$

where  $B$  is the concatenation of  $B_2$  and  $B_6$ .

**2.16 Example** Contrast the prior example with

$$T = \begin{pmatrix} 2 & 2 & 1 \\ 0 & 6 & 2 \\ 0 & 0 & 2 \end{pmatrix}$$

which has the same characteristic polynomial  $(x - 2)^2(x - 6)$ .

While the characteristic polynomial is the same,

$p$	$(T - 6I)^p$	$\mathcal{N}((t - 6)^p)$	<i>nullity</i>
1	$\begin{pmatrix} -4 & 3 & 1 \\ 0 & 0 & 2 \\ 0 & 0 & -4 \end{pmatrix}$	$\left\{ \begin{pmatrix} x \\ (4/3)x \\ 0 \end{pmatrix} \mid x \in \mathbb{C} \right\}$	1
2	$\begin{pmatrix} 16 & -12 & -2 \\ 0 & 0 & -8 \\ 0 & 0 & 16 \end{pmatrix}$	-same-	—

here the action of  $t - 2$  is stable after only one application — the restriction of  $t - 2$  to  $\mathcal{N}_\infty(t - 2)$  is nilpotent of index one. The restriction of  $t - 2$  to the generalized nullspace acts on a string basis as  $\vec{\beta}_1 \mapsto \vec{0}$  and  $\vec{\beta}_2 \mapsto \vec{0}$ , and we get this Jordan block associated with the eigenvalue 2.

$$J_2 = \begin{pmatrix} 2 & 0 \\ 0 & 2 \end{pmatrix}$$

So the contrast with the prior example is that while the characteristic polynomial tells us to look at the action of  $t - 2$  on its generalized nullspace, the characteristic polynomial does not completely describe  $t - 2$ 's action. We must do some computations to find that the minimal polynomial is  $(x - 2)(x - 6)$ .

For the eigenvalue 6 the arguments for the second eigenvalue of the prior example apply again. The restriction of  $t - 6$  to  $\mathcal{N}_\infty(t - 6)$  is nilpotent of index one (it can't be of index less than one and since  $x - 6$  is a factor of the characteristic polynomial with the exponent one it can't be of index more than one either). Thus  $t - 6$ 's canonical form  $N_6$  is the  $1 \times 1$  zero matrix, and the associated Jordan block  $J_6$  is the  $1 \times 1$  matrix with entry 6.

$$\text{Rep}_{B,B}(t) = \begin{pmatrix} 2 & 0 & 0 \\ 0 & 2 & 0 \\ 0 & 0 & 6 \end{pmatrix} \quad B = B_2 \hat{\cup} B_6 = \left\langle \begin{pmatrix} 1 \\ 0 \\ 0 \end{pmatrix}, \begin{pmatrix} 0 \\ 1 \\ -2 \end{pmatrix}, \begin{pmatrix} 2 \\ 4 \\ 0 \end{pmatrix} \right\rangle$$

Checking that the third vector in  $B$  is in the nullspace of  $t - 6$  is routine.

**2.17 Example** A bit of computing with

$$T = \begin{pmatrix} -1 & 4 & 0 & 0 & 0 \\ 0 & 3 & 0 & 0 & 0 \\ 0 & -4 & -1 & 0 & 0 \\ 3 & -9 & -4 & 2 & -1 \\ 1 & 5 & 4 & 1 & 4 \end{pmatrix}$$

shows that its characteristic polynomial is  $(x - 3)^3(x + 1)^2$ . This table

$p$	$(T - 3I)^p$	$\mathcal{N}((t - 3)^p)$	<i>nullity</i>
1	$\begin{pmatrix} -4 & 4 & 0 & 0 & 0 \\ 0 & 0 & 0 & 0 & 0 \\ 0 & -4 & -4 & 0 & 0 \\ 3 & -9 & -4 & -1 & -1 \\ 1 & 5 & 4 & 1 & 1 \end{pmatrix}$	$\left\{ \begin{pmatrix} -(u+v)/2 \\ -(u+v)/2 \\ (u+v)/2 \\ u \\ v \end{pmatrix} \mid u, v \in \mathbb{C} \right\}$	2
2	$\begin{pmatrix} 16 & -16 & 0 & 0 & 0 \\ 0 & 0 & 0 & 0 & 0 \\ 0 & 16 & 16 & 0 & 0 \\ -16 & 32 & 16 & 0 & 0 \\ 0 & -16 & -16 & 0 & 0 \end{pmatrix}$	$\left\{ \begin{pmatrix} -z \\ -z \\ z \\ u \\ v \end{pmatrix} \mid z, u, v \in \mathbb{C} \right\}$	3
3	$\begin{pmatrix} -64 & 64 & 0 & 0 & 0 \\ 0 & 0 & 0 & 0 & 0 \\ 0 & -64 & -64 & 0 & 0 \\ 64 & -128 & -64 & 0 & 0 \\ 0 & 64 & 64 & 0 & 0 \end{pmatrix}$	–same–	–same–

shows that the restriction of  $t - 3$  to  $\mathcal{N}_\infty(t - 3)$  acts on a string basis via the two strings  $\vec{\beta}_1 \mapsto \vec{\beta}_2 \mapsto \vec{0}$  and  $\vec{\beta}_3 \mapsto \vec{0}$ .

A similar calculation for the other eigenvalue

$p$	$(T + 1I)^p$	$\mathcal{N}((t + 1)^p)$	<i>nullity</i>
1	$\begin{pmatrix} 0 & 4 & 0 & 0 & 0 \\ 0 & 4 & 0 & 0 & 0 \\ 0 & -4 & 0 & 0 & 0 \\ 3 & -9 & -4 & 3 & -1 \\ 1 & 5 & 4 & 1 & 5 \end{pmatrix}$	$\left\{ \begin{pmatrix} -(u+v) \\ 0 \\ -v \\ u \\ v \end{pmatrix} \mid u, v \in \mathbb{C} \right\}$	2
2	$\begin{pmatrix} 0 & 16 & 0 & 0 & 0 \\ 0 & 16 & 0 & 0 & 0 \\ 0 & -16 & 0 & 0 & 0 \\ 8 & -40 & -16 & 8 & -8 \\ 8 & 24 & 16 & 8 & 24 \end{pmatrix}$	-same-	-same-

shows that the restriction of  $t + 1$  to its generalized nullspace acts on a string basis via the two separate strings  $\vec{\beta}_4 \mapsto \vec{0}$  and  $\vec{\beta}_5 \mapsto \vec{0}$ .

Therefore  $T$  is similar to this Jordan form matrix.

$$\begin{pmatrix} -1 & 0 & 0 & 0 & 0 \\ 0 & -1 & 0 & 0 & 0 \\ 0 & 0 & 3 & 0 & 0 \\ 0 & 0 & 1 & 3 & 0 \\ 0 & 0 & 0 & 0 & 3 \end{pmatrix}$$

**Exercises**

2.18 Do the check for Example 2.4.

2.19 Each matrix is in Jordan form. State its characteristic polynomial and its minimal polynomial.

(a)  $\begin{pmatrix} 3 & 0 \\ 1 & 3 \end{pmatrix}$     (b)  $\begin{pmatrix} -1 & 0 \\ 0 & -1 \end{pmatrix}$     (c)  $\begin{pmatrix} 2 & 0 & 0 \\ 1 & 2 & 0 \\ 0 & 0 & -1/2 \end{pmatrix}$     (d)  $\begin{pmatrix} 3 & 0 & 0 \\ 1 & 3 & 0 \\ 0 & 1 & 3 \end{pmatrix}$

(e)  $\begin{pmatrix} 3 & 0 & 0 & 0 \\ 1 & 3 & 0 & 0 \\ 0 & 0 & 3 & 0 \\ 0 & 0 & 1 & 3 \end{pmatrix}$     (f)  $\begin{pmatrix} 4 & 0 & 0 & 0 \\ 1 & 4 & 0 & 0 \\ 0 & 0 & -4 & 0 \\ 0 & 0 & 1 & -4 \end{pmatrix}$     (g)  $\begin{pmatrix} 5 & 0 & 0 \\ 0 & 2 & 0 \\ 0 & 0 & 3 \end{pmatrix}$

(h)  $\begin{pmatrix} 5 & 0 & 0 & 0 \\ 0 & 2 & 0 & 0 \\ 0 & 0 & 2 & 0 \\ 0 & 0 & 0 & 3 \end{pmatrix}$     (i)  $\begin{pmatrix} 5 & 0 & 0 & 0 \\ 0 & 2 & 0 & 0 \\ 0 & 1 & 2 & 0 \\ 0 & 0 & 0 & 3 \end{pmatrix}$

✓ 2.20 Find the Jordan form from the given data.

(a) The matrix  $T$  is  $5 \times 5$  with the single eigenvalue 3. The nullities of the powers are:  $T - 3I$  has nullity two,  $(T - 3I)^2$  has nullity three,  $(T - 3I)^3$  has nullity four, and  $(T - 3I)^4$  has nullity five.

(b) The matrix  $S$  is  $5 \times 5$  with two eigenvalues. For the eigenvalue 2 the nullities are:  $S - 2I$  has nullity two, and  $(S - 2I)^2$  has nullity four. For the eigenvalue  $-1$  the nullities are:  $S + I$  has nullity one.

2.21 Find the change of basis matrices for each example.

(a) Example 2.15 (b) Example 2.16 (c) Example 2.17

✓ 2.22 Find the Jordan form and a Jordan basis for each matrix.

$$(a) \begin{pmatrix} -10 & 4 \\ -25 & 10 \end{pmatrix} \quad (b) \begin{pmatrix} 5 & -4 \\ 9 & -7 \end{pmatrix} \quad (c) \begin{pmatrix} 4 & 0 & 0 \\ 2 & 1 & 3 \\ 5 & 0 & 4 \end{pmatrix} \quad (d) \begin{pmatrix} 5 & 4 & 3 \\ -1 & 0 & -3 \\ 1 & -2 & 1 \end{pmatrix}$$

$$(e) \begin{pmatrix} 9 & 7 & 3 \\ -9 & -7 & -4 \\ 4 & 4 & 4 \end{pmatrix} \quad (f) \begin{pmatrix} 2 & 2 & -1 \\ -1 & -1 & 1 \\ -1 & -2 & 2 \end{pmatrix} \quad (g) \begin{pmatrix} 7 & 1 & 2 & 2 \\ 1 & 4 & -1 & -1 \\ -2 & 1 & 5 & -1 \\ 1 & 1 & 2 & 8 \end{pmatrix}$$

✓ 2.23 Find all possible Jordan forms of a transformation with characteristic polynomial  $(x - 1)^2(x + 2)^2$ .

2.24 Find all possible Jordan forms of a transformation with characteristic polynomial  $(x - 1)^3(x + 2)$ .

✓ 2.25 Find all possible Jordan forms of a transformation with characteristic polynomial  $(x - 2)^3(x + 1)$  and minimal polynomial  $(x - 2)^2(x + 1)$ .

2.26 Find all possible Jordan forms of a transformation with characteristic polynomial  $(x - 2)^4(x + 1)$  and minimal polynomial  $(x - 2)^2(x + 1)$ .

✓ 2.27 Diagonalize these.

$$(a) \begin{pmatrix} 1 & 1 \\ 0 & 0 \end{pmatrix} \quad (b) \begin{pmatrix} 0 & 1 \\ 1 & 0 \end{pmatrix}$$

✓ 2.28 Find the Jordan matrix representing the differentiation operator on  $\mathcal{P}_3$ .

✓ 2.29 Decide if these two are similar.

$$\begin{pmatrix} 1 & -1 \\ 4 & -3 \end{pmatrix} \quad \begin{pmatrix} -1 & 0 \\ 1 & -1 \end{pmatrix}$$

2.30 Find the Jordan form of this matrix.

$$\begin{pmatrix} 0 & -1 \\ 1 & 0 \end{pmatrix}$$

Also give a Jordan basis.

2.31 How many similarity classes are there for  $3 \times 3$  matrices whose only eigenvalues are  $-3$  and  $4$ ?

✓ 2.32 Prove that a matrix is diagonalizable if and only if its minimal polynomial has only linear factors.

2.33 Give an example of a linear transformation on a vector space that has no non-trivial invariant subspaces.

2.34 Show that a subspace is  $t - \lambda_1$  invariant if and only if it is  $t - \lambda_2$  invariant.

2.35 Prove or disprove: two  $n \times n$  matrices are similar if and only if they have the same characteristic and minimal polynomials.

2.36 The *trace* of a square matrix is the sum of its diagonal entries.

(a) Find the formula for the characteristic polynomial of a  $2 \times 2$  matrix.

(b) Show that trace is invariant under similarity, and so we can sensibly speak of the 'trace of a map'. (*Hint*: see the prior item.)

(c) Is trace invariant under matrix equivalence?

(d) Show that the trace of a map is the sum of its eigenvalues (counting multiplicities).

(e) Show that the trace of a nilpotent map is zero. Does the converse hold?

2.37 To use Definition 2.7 to check whether a subspace is  $t$  invariant, we seemingly have to check all of the infinitely many vectors in a (nontrivial) subspace to see if they satisfy the condition. Prove that a subspace is  $t$  invariant if and only if its subbasis has the property that for all of its elements,  $t(\vec{\beta})$  is in the subspace.

✓ 2.38 Is  $t$  invariance preserved under intersection? Under union? Complementation? Sums of subspaces?

2.39 Give a way to order the Jordan blocks if some of the eigenvalues are complex numbers. That is, suggest a reasonable ordering for the complex numbers.

2.40 Let  $\mathcal{P}_j(\mathbb{R})$  be the vector space over the reals of degree  $j$  polynomials. Show that if  $j \leq k$  then  $\mathcal{P}_j(\mathbb{R})$  is an invariant subspace of  $\mathcal{P}_k(\mathbb{R})$  under the differentiation operator. In  $\mathcal{P}_7(\mathbb{R})$ , does any of  $\mathcal{P}_0(\mathbb{R}), \dots, \mathcal{P}_6(\mathbb{R})$  have an invariant complement?

2.41 In  $\mathcal{P}_n(\mathbb{R})$ , the vector space (over the reals) of degree  $n$  polynomials,

$$\mathcal{E} = \{p(x) \in \mathcal{P}_n(\mathbb{R}) \mid p(-x) = p(x) \text{ for all } x\}$$

and

$$\mathcal{O} = \{p(x) \in \mathcal{P}_n(\mathbb{R}) \mid p(-x) = -p(x) \text{ for all } x\}$$

are the *even* and the *odd* polynomials;  $p(x) = x^2$  is even while  $p(x) = x^3$  is odd. Show that they are subspaces. Are they complementary? Are they invariant under the differentiation transformation?

2.42 Lemma 2.9 says that if  $M$  and  $N$  are invariant complements then  $t$  has a representation in the given block form (with respect to the same ending as starting basis, of course). Does the implication reverse?

2.43 A matrix  $S$  is the *square root* of another  $T$  if  $S^2 = T$ . Show that any nonsingular matrix has a square root.

## Topic

---

### Method of Powers

In applications the matrices can be quite large. Calculating eigenvalues and eigenvectors by finding and solving the characteristic polynomial can be too slow and too hard. There are techniques that avoid the characteristic polynomial. Here we shall see such a method that is suitable for large matrices that are *sparse*, meaning that the great majority of the entries are zero.

Suppose that the  $n \times n$  matrix  $T$  has  $n$  distinct eigenvalues  $\lambda_1, \lambda_2, \dots, \lambda_n$ . Then  $\mathbb{C}^n$  has a basis made of the associated eigenvectors  $(\vec{z}_1, \dots, \vec{z}_n)$ . For any  $\vec{v} \in \mathbb{C}^n$ , writing  $\vec{v} = c_1 \vec{z}_1 + \dots + c_n \vec{z}_n$  and iterating  $T$  on  $\vec{v}$  gives these.

$$\begin{aligned} T\vec{v} &= c_1 \lambda_1 \vec{z}_1 + c_2 \lambda_2 \vec{z}_2 + \dots + c_n \lambda_n \vec{z}_n \\ T^2\vec{v} &= c_1 \lambda_1^2 \vec{z}_1 + c_2 \lambda_2^2 \vec{z}_2 + \dots + c_n \lambda_n^2 \vec{z}_n \\ T^3\vec{v} &= c_1 \lambda_1^3 \vec{z}_1 + c_2 \lambda_2^3 \vec{z}_2 + \dots + c_n \lambda_n^3 \vec{z}_n \\ &\vdots \\ T^k\vec{v} &= c_1 \lambda_1^k \vec{z}_1 + c_2 \lambda_2^k \vec{z}_2 + \dots + c_n \lambda_n^k \vec{z}_n \end{aligned}$$

Assuming that  $|\lambda_1|$  is the largest and dividing through

$$\frac{T^k\vec{v}}{\lambda_1^k} = c_1 \vec{z}_1 + c_2 \frac{\lambda_2^k}{\lambda_1^k} \vec{z}_2 + \dots + c_n \frac{\lambda_n^k}{\lambda_1^k} \vec{z}_n$$

shows that as  $k$  gets larger the fractions go to zero and so  $\lambda_1$ 's term will dominate the expression. Thus, the entire expression has a limit of  $c_1 \vec{z}_1$ .

Thus if  $c_1 \neq 0$ , as  $k$  increases the vectors  $T^k\vec{v}$  will tend toward the direction of the eigenvectors associated with the dominant eigenvalue, and consequently the ratios  $\|T^k\vec{v}\|/\|T^{k-1}\vec{v}\|$  will tend toward that dominant eigenvalue.

For example the eigenvalues of the matrix

$$T = \begin{pmatrix} 3 & 0 \\ 8 & -1 \end{pmatrix}$$

are 3 and  $-1$ . If for instance  $\vec{v}$  has the components 1 and 1 then



$$\begin{array}{c|ccc}
 \vec{v} & T\vec{v} & T^2\vec{v} & \dots & T^9\vec{v} & T^{10}\vec{v} \\
 \hline
 \begin{pmatrix} 1 \\ 1 \end{pmatrix} & \begin{pmatrix} 3 \\ 7 \end{pmatrix} & \begin{pmatrix} 9 \\ 17 \end{pmatrix} & \dots & \begin{pmatrix} 19\,683 \\ 39\,367 \end{pmatrix} & \begin{pmatrix} 59\,049 \\ 118\,097 \end{pmatrix}
 \end{array}$$

and the ratio between the lengths of the last two is 2.9999.

We shall note two implementation issues. First, instead of finding the powers of  $T$  and applying them to  $\vec{v}$ , we will compute  $\vec{v}_1$  as  $T\vec{v}$  and then compute  $\vec{v}_2$  as  $T\vec{v}_1$ , etc. (that is, we do not separately calculate  $T^2, T^3, \dots$ ). We can quickly do these matrix-vector products even if  $T$  is large, provided that it is sparse. The second issue is that to avoid generating numbers that are so large that they overflow our computer's capability, we can normalize the  $\vec{v}_i$ 's at each step. For instance, we can divide each  $\vec{v}_i$  by its length (other possibilities are to divide it by its largest component, or simply by its first component). We thus implement this method by generating

$$\begin{aligned}
 \vec{w}_0 &= \vec{v}_0 / \|\vec{v}_0\| \\
 \vec{v}_1 &= T\vec{w}_0 \\
 \vec{w}_1 &= \vec{v}_1 / \|\vec{v}_1\| \\
 \vec{v}_2 &= T\vec{w}_1 \\
 &\vdots \\
 \vec{w}_{k-1} &= \vec{v}_{k-1} / \|\vec{v}_{k-1}\| \\
 \vec{v}_k &= T\vec{w}_{k-1}
 \end{aligned}$$

until we are satisfied. Then  $\vec{v}_k$  is an approximation of an eigenvector, and the approximation of the dominant eigenvalue is the ratio  $\|\vec{v}_k\| / \|\vec{v}_{k-1}\|$ .

One way that we could be 'satisfied' is to iterate until our approximation of the eigenvalue settles down. We could decide for instance to stop the iteration process not after some fixed number of steps, but instead when  $\|\vec{v}_k\|$  differs from  $\|\vec{v}_{k-1}\|$  by less than one percent, or when they agree up to the second significant digit.

The rate of convergence is determined by the rate at which the powers of  $|\lambda_2/\lambda_1|$  go to zero, where  $\lambda_2$  is the eigenvalue of second largest norm. If that ratio is much less than one then convergence is fast but if it is only slightly less than one then convergence can be quite slow. Consequently, the method of powers is not the most commonly used way of finding eigenvalues (although it is the simplest one, which is why it is here). Instead, there are a variety of methods that generally work by first replacing the given matrix  $T$  with another that is similar to it and so has the same eigenvalues, but is in some reduced form such as *tridiagonal form*, where the only nonzero entries are on the diagonal, or just above or below it. Then special techniques can find the eigenvalues. Once we know the eigenvalues then we can easily compute the eigenvectors of  $T$ . These other methods are outside of our scope. A good reference is [Goult, *et al.*]

## Exercises

1 Use ten iterations to estimate the largest eigenvalue of these matrices, starting from the vector with components 1 and 2. Compare the answer with the one obtained by solving the characteristic equation.

$$(a) \begin{pmatrix} 1 & 5 \\ 0 & 4 \end{pmatrix} \quad (b) \begin{pmatrix} 3 & 2 \\ -1 & 0 \end{pmatrix}$$

2 Redo the prior exercise by iterating until  $\|\vec{v}_k\| - \|\vec{v}_{k-1}\|$  has absolute value less than 0.01. At each step, normalize by dividing each vector by its length. How many iterations does it take? Are the answers significantly different?

3 Use ten iterations to estimate the largest eigenvalue of these matrices, starting from the vector with components 1, 2, and 3. Compare the answer with the one obtained by solving the characteristic equation.

$$(a) \begin{pmatrix} 4 & 0 & 1 \\ -2 & 1 & 0 \\ -2 & 0 & 1 \end{pmatrix} \quad (b) \begin{pmatrix} -1 & 2 & 2 \\ 2 & 2 & 2 \\ -3 & -6 & -6 \end{pmatrix}$$

4 Redo the prior exercise by iterating until  $\|\vec{v}_k\| - \|\vec{v}_{k-1}\|$  has absolute value less than 0.01. At each step, normalize by dividing each vector by its length. How many iterations does it take? Are the answers significantly different?

5 What happens if  $c_1 = 0$ ? That is, what happens if the initial vector does not to have any component in the direction of the relevant eigenvector?

6 How can we adapt the method of powers to find the smallest eigenvalue?

## Computer Code

This is the code for the computer algebra system Octave that did the calculation above. (It has been lightly edited to remove blank lines, etc.)

```
>T=[3, 0;
    8, -1]
T=
    3    0
    8   -1
>v0=[1; 2]
v0=
    1
    2
>v1=T*v0
v1=
    3
    7
>v2=T*v1
v2=
    9
   17
>T9=T**9
T9=
 19683    0
 39368   -1
>T10=T**10
T10=
 59049    0
118096    1
>v9=T9*v0
v9=
 19683
 39367
>v10=T10*v0
v10=
 59049
118096
>norm(v10)/norm(v9)
ans=2.9999
```

*Remark.* This does not use the full power of Octave; it has built-in functions to automatically apply sophisticated methods to find eigenvalues and eigenvectors.

## Topic

---

### Stable Populations

Imagine a reserve park with animals from a species that we are trying to protect. The park doesn't have a fence and so animals cross the boundary, both from the inside out and from the outside in. Every year, 10% of the animals from inside of the park leave and 1% of the animals from the outside find their way in. We can ask if there is a stable level: are there populations for the park and the rest of the world that will stay constant over time, with the number of animals leaving equal to the number of animals entering?

Let  $p_n$  be the year  $n$  population in the park and let  $r_n$  be the population in the rest of the world.

$$\begin{aligned} p_{n+1} &= .90p_n + .01r_n \\ r_{n+1} &= .10p_n + .99r_n \end{aligned}$$

We have this matrix equation.

$$\begin{pmatrix} p_{n+1} \\ r_{n+1} \end{pmatrix} = \begin{pmatrix} .90 & .01 \\ .10 & .99 \end{pmatrix} \begin{pmatrix} p_n \\ r_n \end{pmatrix}$$

The population will be stable if  $p_{n+1} = p_n$  and  $r_{n+1} = r_n$  so that the matrix equation  $\vec{v}_{n+1} = T\vec{v}_n$  becomes  $\vec{v} = T\vec{v}$ . We are therefore looking for eigenvectors for  $T$  that are associated with the eigenvalue  $\lambda = 1$ . The equation  $\vec{0} = (\lambda I - T)\vec{v} = (I - T)\vec{v}$  is

$$\begin{pmatrix} 0.10 & -0.01 \\ -0.10 & 0.01 \end{pmatrix} \begin{pmatrix} p \\ r \end{pmatrix} = \begin{pmatrix} 0 \\ 0 \end{pmatrix}$$

which gives the eigenspace: vectors with the restriction that  $p = .1r$ . For example, if we start with a park population  $p = 10,000$  animals, so that the rest of the world has  $r = 100,000$  animals then every year ten percent of those inside will leave the park (this is a thousand animals), and every year one percent of those from the rest of the world will enter the park (also a thousand animals). It is stable, self-sustaining.

Now imagine that we are trying to raise the total world population of this species. For instance we can try to have the world population grow at a regular rate of 1% per year. This would make the population level stable in some sense,

although it is a dynamic stability in contrast to the static population level of the  $\lambda = 1$  case. The equation  $\vec{v}_{n+1} = 1.01 \cdot \vec{v}_n = T\vec{v}_n$  leads to  $((1.01I - T)\vec{v} = \vec{0}$ , which gives this system.

$$\begin{pmatrix} 0.11 & -0.01 \\ -0.10 & 0.02 \end{pmatrix} \begin{pmatrix} p \\ r \end{pmatrix} = \begin{pmatrix} 0 \\ 0 \end{pmatrix}$$

This matrix is nonsingular and so the only solution is  $p = 0$ ,  $r = 0$ . Thus there is no nontrivial initial population that would lead to a regular annual one percent growth rate in  $p$  and  $r$ .

We can look for the rates that allow an initial population for the park that results in a steady growth behavior. We consider  $\lambda\vec{v} = T\vec{v}$  and solve for  $\lambda$ .

$$0 = \begin{vmatrix} \lambda - .9 & .01 \\ .10 & \lambda - .99 \end{vmatrix} = (\lambda - .9)(\lambda - .99) - (.10)(.01) = \lambda^2 - 1.89\lambda + .89$$

We already know that  $\lambda = 1$  is one solution of this characteristic equation and finding that the other eigenvalue is  $0.89$  is routine. Thus there are two ways to have a dynamically stable  $p$  and  $r$  (where the two grow at the same rate despite the leaky park boundaries): have a world population that is does not grow or shrink, and have a world population that shrinks by 11% every year.

This is one way to look at eigenvalues and eigenvectors—they give a stable state for a system. If the eigenvalue is one then the system is static. If the eigenvalue isn't one then it is a dynamic stability, where the parts of the system grow or shrink together.

### Exercises

- 1 For the park discussed above, what should be the initial park population in the case where the populations decline by 11% every year?
- 2 What will happen to the population of the park in the event of a growth in world population of 1% per year? Will it lag the world growth, or lead it? Assume that the initial park population is ten thousand, and the world population is one hundred thousand, and calculate over a ten year span.
- 3 The park discussed above is partially fenced so that now, every year, only 5% of the animals from inside of the park leave (still, about 1% of the animals from the outside find their way in). Under what conditions can the park maintain a stable population now?
- 4 Suppose that a species of bird only lives in Canada, the United States, or in Mexico. Every year, 4% of the Canadian birds travel to the US, and 1% of them travel to Mexico. Every year, 6% of the US birds travel to Canada, and 4% go to Mexico. From Mexico, every year 10% travel to the US, and 0% go to Canada.
  - (a) Give the transition matrix.
  - (b) Is there a way for the three countries to have constant populations?
  - (c) Find all stable situations.

## Page Ranking

Imagine that you are looking for the best book on Linear Algebra. You probably would try a web search engine such as Google. These lists pages ranked by importance. The ranking is defined, as Google's founders have said in [Brin & Page], that a page is important if other important pages link to it: "a page can have a high PageRank if there are many pages that point to it, or if there are some pages that point to it and have a high PageRank." But isn't that circular — how can they tell whether a page is important without first deciding on the important pages? With eigenvalues and eigenvectors.

We will present a simplified version of the Page Rank algorithm. For that we will model the World Wide Web as a collection of pages connected by links. This diagram, from [Wills], shows the pages as circles, and the links as arrows; for instance, page  $p_1$  has a link to page  $p_2$ .

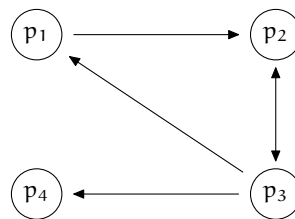

The key idea is that pages that should be highly ranked if they are cited often by other pages. That is, we raise the importance of a page  $p_i$  if it is linked-to from page  $p_j$ . The increment depends on the importance of the linking page  $p_j$  divided by how many out-links  $a_j$  are on that page.

$$J(p_i) = \sum_{\text{in-linking pages } p_j} \frac{J(p_j)}{a_j}$$

This matrix stores the information.

$$\begin{pmatrix} 0 & 0 & 1/3 & 0 \\ 1 & 0 & 1/3 & 0 \\ 0 & 1 & 0 & 0 \\ 0 & 0 & 1/3 & 0 \end{pmatrix}$$

The algorithm's inventors describe a way to think about that matrix.

PageRank can be thought of as a model of user behavior. We assume there is a 'random surfer' who is given a web page at random and keeps clicking on links, never hitting "back" ... The probability that the random surfer visits a page is its PageRank. [Brin & Page]

In the diagram, a surfer on page  $p_3$  has a probability  $1/3$  of going next to each of the other pages.

That leads us to the problem of page  $p_4$ . Many targets of links are *dangling* or *sink links*, without any outbound links. (For instance, a page may link to an image.) The simplest way to model what could happen next is to imagine that when the surfer gets to a page like this then they go to a next page entirely at random.

$$H = \begin{pmatrix} 0 & 0 & 1/3 & 1/4 \\ 1 & 0 & 1/3 & 1/4 \\ 0 & 1 & 0 & 1/4 \\ 0 & 0 & 1/3 & 1/4 \end{pmatrix}$$

We will find vector  $\vec{J}$  whose components are the importance rankings of each page  $J(p_i)$ . With this notation, our requirements for the page rank are that  $H\vec{J} = \vec{J}$ . That is, we want an eigenvector of the matrix associated with the eigenvalue  $\lambda = 1$ .

Here is *Sage*'s calculation of the eigenvectors (slightly edited to fit on the page).

```
sage: H=matrix([[0,0,1/3,1/4], [1,0,1/3,1/4], [0,1,0,1/4], [0,0,1/3,1/4]])
sage: H.eigenvectors_right()
[(1, [(1, 2, 9/4, 1)
], 1), (0, [(0, 1, 3, -4)
], 1), (-0.3750000000000000? - 0.4389855730355308?*I,
[(1, -0.1250000000000000? + 1.316956719106593?*I,
-1.8750000000000000? - 1.316956719106593?*I, 1)], 1),
(-0.3750000000000000? + 0.4389855730355308?*I,
[(1, -0.1250000000000000? - 1.316956719106593?*I,
-1.8750000000000000? + 1.316956719106593?*I, 1)], 1)]
```

The eigenvector that *Sage* gives associated with the eigenvalue  $\lambda = 1$  is this.

$$\begin{pmatrix} 1 \\ 2 \\ 9/4 \\ 1 \end{pmatrix}$$

Of course, there are many vectors in that eigenspace. To get a page rank number we normalize to length one.

```
sage: v=vector([1, 2, 9/4, 1])
sage: v/v.norm()
(4/177*sqrt(177), 8/177*sqrt(177), 3/59*sqrt(177), 4/177*sqrt(177))
sage: w=v/v.norm()
sage: w.n()
(0.300658411201132, 0.601316822402263, 0.676481425202546, 0.300658411201132)
```

So we rank the first and fourth pages as of equal importance. We rank the second and third pages as much more important than those, and about equal in importance as each other.

We'll add one more refinement. We will allow the surfer to pick a new page at random even if they are not on a dangling page. Let this happen with probability  $\alpha$ .

$$G = \alpha \cdot \begin{pmatrix} 0 & 0 & 1/3 & 1/4 \\ 1 & 0 & 1/3 & 1/4 \\ 0 & 1 & 0 & 1/4 \\ 0 & 0 & 1/3 & 1/4 \end{pmatrix} + (1 - \alpha) \cdot \begin{pmatrix} 1/4 & 1/4 & 1/4 & 1/4 \\ 1/4 & 1/4 & 1/4 & 1/4 \\ 1/4 & 1/4 & 1/4 & 1/4 \\ 1/4 & 1/4 & 1/4 & 1/4 \end{pmatrix}$$

This is the *Google matrix*.

In practice  $\alpha$  is typically between 0.85 and 0.99. Here are the ranks for the four pages with a spread of  $\alpha$ 's.

$\alpha$	0.85	0.90	0.95	0.99
$p_1$	0.325	0.317	0.309	0.302
$p_2$	0.602	0.602	0.602	0.601
$p_3$	0.652	0.661	0.669	0.675
$p_4$	0.325	0.317	0.309	0.302

The details of the algorithms used by commercial search engines are secret, no doubt have many refinements, and also change frequently. But the inventors of Google were gracious enough to outline the basis for their work in [Brin & Page]. A more current source is [Wikipedia Google Page Rank]. Two additional excellent expositions are [Wills] and [Austin].

### Exercises

- 1 A square matrix is *stochastic* if the sum of the entries in each column is one. The Google matrix is computed by taking a combination  $G = \alpha * H + (1 - \alpha) * S$  of two stochastic matrices. Show that  $G$  must be stochastic.
- 2 For this web of pages, the importance of each page should be equal. Verify it for  $\alpha = 0.85$ .

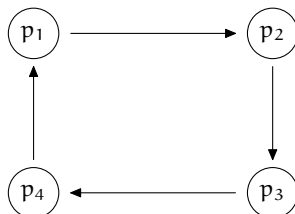

- 3 [Bryan & Leise] Give the importance ranking for this web of pages.

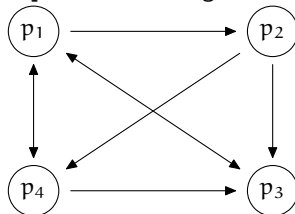



- (a) Use  $\alpha = 0.85$ .
- (b) Use  $\alpha = 0.95$ .
- (c) Observe that while  $p_3$  is linked-to from all other pages, and therefore seems important, it is not the highest ranked page. What is the highest ranked page? Explain.

## Topic

---

# Linear Recurrences

In 1202 Leonardo of Pisa, known as Fibonacci, posed this problem.

A certain man put a pair of rabbits in a place surrounded on all sides by a wall. How many pairs of rabbits can be produced from that pair in a year if it is supposed that every month each pair begets a new pair which from the second month on becomes productive?

This moves past an elementary exponential growth model for populations to include the fact that there is an initial period where newborns are not fertile. However, it retains other simplifying assumptions such as that there is no gestation period and no mortality.

To get next month's total number of pairs we add the number of pairs alive this month to the number of pairs that will be newly born next month. The latter number is the number of pairs of parents that will be productive next month, which is the number that next month will have been alive for at least two months, and that is the number that were alive last month.

$$f(n+1) = f(n) + f(n-1) \quad \text{where } f(0) = 0, f(1) = 1$$

We call this a *recurrence relation* because  $f$  recurs in its own defining equation. With it we can answer Fibonacci's twelve-month question.

<i>month</i>	0	1	2	3	4	5	6	7	8	9	10	11	12
<i>pairs</i>	0	1	1	2	3	5	8	13	21	34	55	89	144

The sequence of numbers defined by the above equation is the *Fibonacci sequence*. We will give a formula to calculate  $f(n+1)$  without having to first calculate  $f(n)$ ,  $f(n-1)$ , etc.

We can give the recurrence a matrix formulation.

$$\begin{pmatrix} 1 & 1 \\ 1 & 0 \end{pmatrix} \begin{pmatrix} f(n) \\ f(n-1) \end{pmatrix} = \begin{pmatrix} f(n+1) \\ f(n) \end{pmatrix} \quad \text{where } \begin{pmatrix} f(1) \\ f(0) \end{pmatrix} = \begin{pmatrix} 1 \\ 0 \end{pmatrix}$$

Writing  $T$  for the matrix and  $\vec{v}_n$  for the vector with components  $f(n+1)$  and  $f(n)$ , we have that  $\vec{v}_n = T^n \vec{v}_0$ . The advantage of this formulation comes from diagonalizing  $T$  because then we have a fast way to compute its powers: if

$T = PDP^{-1}$  then  $T^n = PD^nP^{-1}$  and the  $n$ -th power of the diagonal matrix  $D$  is the diagonal matrix whose entries are the  $n$ -th powers of the entries of  $D$ .

The characteristic equation of  $T$  is  $\lambda^2 - \lambda - 1$ . The quadratic formula gives its roots as  $(1 + \sqrt{5})/2$  and  $(1 - \sqrt{5})/2$ . (*Remark:* these are sometimes called “golden ratios;” see [Falbo].) Diagonalizing gives this.

$$\begin{pmatrix} 1 & 1 \\ 1 & 0 \end{pmatrix} = \begin{pmatrix} \frac{1+\sqrt{5}}{2} & \frac{1-\sqrt{5}}{2} \\ 1 & 1 \end{pmatrix} \begin{pmatrix} \frac{1+\sqrt{5}}{2} & 0 \\ 0 & \frac{1-\sqrt{5}}{2} \end{pmatrix} \begin{pmatrix} \frac{1}{\sqrt{5}} & -\frac{1-\sqrt{5}}{2\sqrt{5}} \\ -\frac{1}{\sqrt{5}} & \frac{1+\sqrt{5}}{2\sqrt{5}} \end{pmatrix}$$

Introducing the vectors and taking the  $n$ -th power, we have

$$\begin{aligned} \begin{pmatrix} f(n+1) \\ f(n) \end{pmatrix} &= \begin{pmatrix} 1 & 1 \\ 1 & 0 \end{pmatrix}^n \begin{pmatrix} f(1) \\ f(0) \end{pmatrix} \\ &= \begin{pmatrix} \frac{1+\sqrt{5}}{2} & \frac{1-\sqrt{5}}{2} \\ 1 & 1 \end{pmatrix} \begin{pmatrix} \left(\frac{1+\sqrt{5}}{2}\right)^n & 0 \\ 0 & \left(\frac{1-\sqrt{5}}{2}\right)^n \end{pmatrix} \begin{pmatrix} \frac{1}{\sqrt{5}} & -\frac{1-\sqrt{5}}{2\sqrt{5}} \\ -\frac{1}{\sqrt{5}} & \frac{1+\sqrt{5}}{2\sqrt{5}} \end{pmatrix} \begin{pmatrix} 1 \\ 0 \end{pmatrix} \end{aligned}$$

The calculation is ugly but not hard.

$$\begin{aligned} \begin{pmatrix} f(n+1) \\ f(n) \end{pmatrix} &= \begin{pmatrix} \frac{1+\sqrt{5}}{2} & \frac{1-\sqrt{5}}{2} \\ 1 & 1 \end{pmatrix} \begin{pmatrix} \left(\frac{1+\sqrt{5}}{2}\right)^n & 0 \\ 0 & \left(\frac{1-\sqrt{5}}{2}\right)^n \end{pmatrix} \begin{pmatrix} \frac{1}{\sqrt{5}} \\ -\frac{1}{\sqrt{5}} \end{pmatrix} \\ &= \begin{pmatrix} \frac{1+\sqrt{5}}{2} & \frac{1-\sqrt{5}}{2} \\ 1 & 1 \end{pmatrix} \begin{pmatrix} \frac{1}{\sqrt{5}} \left(\frac{1+\sqrt{5}}{2}\right)^n \\ -\frac{1}{\sqrt{5}} \left(\frac{1-\sqrt{5}}{2}\right)^n \end{pmatrix} \\ &= \begin{pmatrix} \frac{1}{\sqrt{5}} \left(\frac{1+\sqrt{5}}{2}\right)^{n+1} - \frac{1}{\sqrt{5}} \left(\frac{1-\sqrt{5}}{2}\right)^{n+1} \\ \frac{1}{\sqrt{5}} \left(\frac{1+\sqrt{5}}{2}\right)^n - \frac{1}{\sqrt{5}} \left(\frac{1-\sqrt{5}}{2}\right)^n \end{pmatrix} \end{aligned}$$

We want the second component of that equation.

$$f(n) = \frac{1}{\sqrt{5}} \left[ \left(\frac{1+\sqrt{5}}{2}\right)^n - \left(\frac{1-\sqrt{5}}{2}\right)^n \right]$$

This formula finds the value of any member of the sequence without having to first find the intermediate values. Notice that  $(1 - \sqrt{5})/2 \approx -0.618$  has absolute value less than one and so its powers go to zero. Thus the formula giving  $f(n)$  is dominated by its first term.

Although we have extended the elementary model of population growth by adding a delay period before the onset of fertility, we nonetheless still get a function that is asymptotically exponential.

In general, a *linear recurrence relation* (or *difference equation*) has this form.

$$f(n+1) = a_n f(n) + a_{n-1} f(n-1) + \cdots + a_{n-k} f(n-k)$$

This recurrence relation is *homogeneous* because there is no constant term, i.e., we can rewrite it into the form  $0 = -f(n+1) + a_n f(n) + a_{n-1} f(n-1) + \cdots +$

$a_{n-k}f(n-k)$ . We say that this relation is of *order*  $k$ . The relation along with the *initial conditions*  $f(0), \dots, f(k)$  completely determines a sequence. For instance, the Fibonacci relation is of order two and, along with the two initial conditions  $f(0) = 0$  and  $f(1) = 1$ , it determines the Fibonacci sequence simply because we can compute any  $f(n)$  by first computing  $f(2), f(3)$ , etc. We shall see how to use linear algebra to solve a linear recurrence relation—to find a formula that computes the  $n$ -th member of the sequence without having to first compute the values of the prior members.

Let  $V$  be the set of functions with domain  $\mathbb{N} = \{0, 1, 2, \dots\}$ . (We shall use the codomain  $\mathbb{R}$  but we could use others, such as  $\mathbb{C}$ . Below we sometimes have domain  $\{1, 2, \dots\}$  but it is not an important difference.) This is a vector space with the usual meaning for addition and scalar multiplication of functions, that the action of  $f + g$  is  $x \mapsto f(x) + g(x)$  and the action of  $cf$  is  $x \mapsto c \cdot f(x)$ .

If we omit the initial conditions then there may be many functions satisfying a recurrence. For example, the function  $g$  whose first few values are  $g(0) = 1$ ,  $g(1) = 2$ ,  $g(2) = 3$ ,  $g(3) = 4$ , and  $g(4) = 7$  solves the Fibonacci relation without the Fibonacci initial conditions.

Fix a relation and consider the subset  $S$  of functions satisfying the relation without initial conditions. We claim that it is a subspace of  $V$ . It is nonempty because the zero function is a solution. It is closed under addition since if  $f_1$  and  $f_2$  are solutions, then this holds.

$$\begin{aligned} a_{n+1}(f_1 + f_2)(n+1) + \dots + a_{n-k}(f_1 + f_2)(n-k) \\ &= (a_{n+1}f_1(n+1) + \dots + a_{n-k}f_1(n-k)) \\ &\quad + (a_{n+1}f_2(n+1) + \dots + a_{n-k}f_2(n-k)) \\ &= 0 \end{aligned}$$

It is also closed under scalar multiplication.

$$\begin{aligned} a_{n+1}(rf_1)(n+1) + \dots + a_{n-k}(rf_1)(n-k) \\ &= r(a_{n+1}f_1(n+1) + \dots + a_{n-k}f_1(n-k)) \\ &= r \cdot 0 \\ &= 0 \end{aligned}$$

We can find the dimension of  $S$ . Consider this map from the set of functions  $S$  to the set of  $k$ -tall vectors.

$$f \mapsto \begin{pmatrix} f(0) \\ f(1) \\ \vdots \\ f(k) \end{pmatrix}$$

Exercise 3 shows that this map is linear. Because any solution of the recurrence is uniquely determined by the  $k$  initial conditions, this map is one-to-one and onto. Thus it is an isomorphism and thus  $S$  has dimension  $k$ , the order of the recurrence.

So we can describe the set of solutions of our linear homogeneous recurrence relation of degree  $k$  (again, without any initial conditions) by taking linear combinations of a set having only  $k$ -many linearly independent functions.

To produce those equations we give the recurrence  $f(n+1) = a_n f(n) + \dots + a_{n-k} f(n-k)$  a matrix formulation.

$$\begin{pmatrix} a_n & a_{n-1} & a_{n-2} & \dots & a_{n-k+1} & a_{n-k} \\ 1 & 0 & 0 & \dots & 0 & 0 \\ 0 & 1 & 0 & & & \\ 0 & 0 & 1 & & & \\ \vdots & \vdots & & \ddots & & \vdots \\ 0 & 0 & 0 & \dots & 1 & 0 \end{pmatrix} \begin{pmatrix} f(n) \\ f(n-1) \\ \vdots \\ f(n-k) \end{pmatrix} = \begin{pmatrix} f(n+1) \\ f(n) \\ \vdots \\ f(n-k+1) \end{pmatrix}$$

We want the characteristic function of the matrix, the determinant of  $A - \lambda I$  where the above matrix is  $A$ . The pattern in the  $2 \times 2$  case

$$\begin{pmatrix} a_n - \lambda & a_{n-1} \\ 1 & -\lambda \end{pmatrix} = \lambda^2 - a_n \lambda - a_{n-1}$$

and the  $3 \times 3$  case

$$\begin{pmatrix} a_n - \lambda & a_{n-1} & a_{n-2} \\ 1 & -\lambda & 0 \\ 0 & 1 & -\lambda \end{pmatrix} = -\lambda^3 + a_n \lambda^2 + a_{n-1} \lambda + a_{n-2}$$

leads us to expect (and Exercise 4 verifies) that this is the characteristic equation.

$$\begin{vmatrix} a_n - \lambda & a_{n-1} & a_{n-2} & \dots & a_{n-k+1} & a_{n-k} \\ 1 & -\lambda & 0 & \dots & 0 & 0 \\ 0 & 1 & -\lambda & & & \\ 0 & 0 & 1 & & & \\ \vdots & \vdots & & \ddots & & \vdots \\ 0 & 0 & 0 & \dots & 1 & -\lambda \end{vmatrix} \\ = \pm(-\lambda^k + a_n \lambda^{k-1} + a_{n-1} \lambda^{k-2} + \dots + a_{n-k+1} \lambda + a_{n-k})$$

The  $\pm$  is irrelevant to find the roots so we will drop it. We say that the polynomial is 'associated' with the recurrence relation.

If  $-\lambda^k + a_n \lambda^{k-1} + a_{n-1} \lambda^{k-2} + \dots + a_{n-k+1} \lambda + a_{n-k}$  has no repeated roots then the matrix is diagonalizable and we can, in theory, get a formula for  $f(n)$  as in the Fibonacci case. But because we know that the subspace of solutions has dimension  $k$ , we do not need to do the diagonalization calculation provided that we can exhibit  $k$  linearly independent functions satisfying the relation.

Where  $r_1, r_2, \dots, r_k$  are the distinct roots, consider the functions  $f_{r_1}(n) = r_1^n$  through  $f_{r_k}(n) = r_k^n$  of powers of those roots. Exercise 5 shows that each is a solution of the recurrence and that they form a linearly independent set. So if the roots  $r_1, \dots, r_k$  of the associated polynomial are distinct then any solution

of the relation has the form  $f(n) = c_1 r_1^n + c_2 r_2^n + \cdots + c_k r_k^n$  for  $c_1, \dots, c_n \in \mathbb{R}$ . (The case of repeated roots is similar but we won't cover it here; see any text on Discrete Mathematics.)

Now we bring in the initial conditions. Use them to solve for  $c_1, \dots, c_n$ . For instance, the polynomial associated with the Fibonacci relation is  $-\lambda^2 + \lambda + 1$ , whose roots are  $(1 \pm \sqrt{5})/2$  and so any solution of the Fibonacci equation has the form  $f(n) = c_1((1 + \sqrt{5})/2)^n + c_2((1 - \sqrt{5})/2)^n$ . Including the initial conditions for the cases  $n = 0$  and  $n = 1$  gives

$$\begin{aligned} c_1 + c_2 &= 0 \\ (1 + \sqrt{5}/2)c_1 + (1 - \sqrt{5}/2)c_2 &= 1 \end{aligned}$$

which yields  $c_1 = 1/\sqrt{5}$  and  $c_2 = -1/\sqrt{5}$ , as we found above.

We close by considering the nonhomogeneous case, where the relation has the form  $f(n+1) = a_n f(n) + a_{n-1} f(n-1) + \cdots + a_{n-k} f(n-k) + b$  for some nonzero  $b$ . We only need a small adjustment to make the transition from the homogeneous case. This classic example illustrates.

In 1883, Edouard Lucas posed the following problem, today called the *Tower of Hanoi*.

In the great temple at Benares, beneath the dome which marks the center of the world, rests a brass plate in which are fixed three diamond needles, each a cubit high and as thick as the body of a bee. On one of these needles, at the creation, God placed sixty four disks of pure gold, the largest disk resting on the brass plate, and the others getting smaller and smaller up to the top one. This is the Tower of Brahma. Day and night unceasingly the priests transfer the disks from one diamond needle to another according to the fixed and immutable laws of Bram-ah, which require that the priest on duty must not move more than one disk at a time and that he must place this disk on a needle so that there is no smaller disk below it. When the sixty-four disks shall have been thus transferred from the needle on which at the creation God placed them to one of the other needles, tower, temple, and Brahmins alike will crumble into dust, and with a thunderclap the world will vanish. (Translation of [De Parville] from [Ball & Coxeter].)

How many disk moves will it take? Instead of tackling the sixty four disk problem right away, we will consider the problem for smaller numbers of disks, starting with three.

To begin, all three disks are on the same needle.

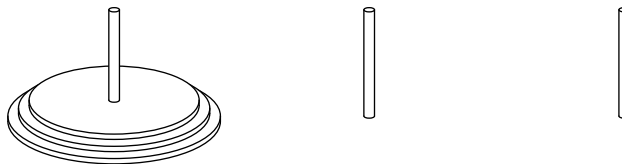

After moving the small disk to the far needle, the mid-sized disk to the middle needle, and then moving the small disk to the middle needle we have this.

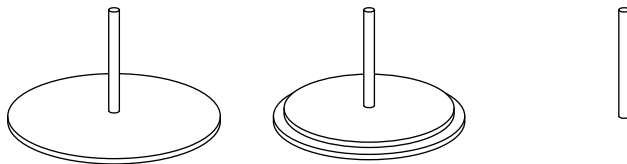

Now we can move the big disk over. Then to finish we repeat the process of moving the two smaller disks, this time so that they end up on the third needle, on top of the big disk.

So to move the bottom disk at a minimum we must first move the smaller disks to the middle needle, then move the big one, and then move all the smaller ones from the middle needle to the ending needle. Since this minimum suffices, we get this recurrence for the number of moves.

$$T(n+1) = T(n) + 1 + T(n) = 2T(n) + 1 \quad \text{where } T(1) = 1$$

We can easily compute the first few values of  $T$ .

$n$	1	2	3	4	5	6	7	8	9	10
$T(n)$	1	3	7	15	31	63	127	255	511	1023

Of course, those numbers are one less than a power of two. To derive this equation instead of just guessing at it, we write the original relation as  $-1 = -T(n+1) + 2T(n)$ , consider the homogeneous relation  $0 = -T(n) + 2T(n-1)$ , get its associated polynomial  $-\lambda + 2$ , which obviously has the single root  $r_1 = 2$ , and conclude that functions satisfying the homogeneous relation take the form  $T(n) = c_1 2^n$ .

That's the homogeneous solution. Now we need a particular solution. Because the nonhomogeneous relation  $-1 = -T(n+1) + 2T(n)$  is so simple, in a few minutes (or by remembering the table) we can spot a particular solution,  $T(n) = -1$ . So we have that (without yet considering the initial condition) any solution of  $T(n+1) = 2T(n) + 1$  is the sum of the homogeneous solution and this particular solution:  $T(n) = c_1 2^n - 1$ . The initial condition  $T(1) = 1$  now gives that  $c_1 = 1$ , and we've gotten the formula that generates the table: the  $n$ -disk Tower of Hanoi problem requires a minimum of  $2^n - 1$  moves.

Finding a particular solution in more complicated cases is, unsurprisingly, more complicated. A delightful and rewarding, but challenging, source on recurrence relations is [Graham, Knuth, Patashnik]. For more on the Tower of Hanoi, [Ball & Coxeter] or [Gardner 1957] are good starting points. So is [Hofstadter]. Some computer code for trying some recurrence relations follows the exercises.

### Exercises

- Solve each homogeneous linear recurrence relations.
  - $f(n+1) = 5f(n) - 6f(n-1)$

- (b)  $f(n+1) = 4f(n-1)$   
 (c)  $f(n+1) = 5f(n) - 2f(n-1) - 8f(n-2)$
- 2 Give a formula for the relations of the prior exercise, with these initial conditions.
- (a)  $f(0) = 1, f(1) = 1$   
 (b)  $f(0) = 0, f(1) = 1$   
 (c)  $f(0) = 1, f(1) = 1, f(2) = 3$ .
- 3 Check that the isomorphism given between  $S$  and  $\mathbb{R}^k$  is a linear map. We argue above that this map is one-to-one. What is its inverse?
- 4 Show that the characteristic equation of the matrix is as stated, that is, is the polynomial associated with the relation. (Hint: expanding down the final column, and using induction will work.)
- 5 Given a homogeneous linear recurrence relation  $f(n+1) = a_n f(n) + \dots + a_{n-k} f(n-k)$ , let  $r_1, \dots, r_k$  be the roots of the associated polynomial.
- (a) Prove that each function  $f_{r_i}(n) = r_i^n$  satisfies the recurrence (without initial conditions).  
 (b) Prove that no  $r_i$  is 0.  
 (c) Prove that the set  $\{f_{r_1}, \dots, f_{r_k}\}$  is linearly independent.
- 6 (This refers to the value  $T(64) = 18,446,744,073,709,551,615$  given in the computer code below.) Transferring one disk per second, how many years would it take the priests at the Tower of Hanoi to finish the job?

### Computer Code

This code allows the generation of the first few values of a function defined by a recurrence and initial conditions. It is in the Scheme dialect of LISP (specifically, it shows A. Jaffer's free scheme interpreter SCM although any Scheme implementation should work).

First, the Tower of Hanoi code is a straightforward implementation of the recurrence.

```
(define (tower-of-hanoi-moves n)
  (if (= n 1)
      1
      (+ (* (tower-of-hanoi-moves (- n 1))
            2)
         1)
    )
  )
```

(Note for readers unused to recursive code: to compute  $T(64)$ , the computer wants to compute  $2 * T(63) - 1$ , which requires computing  $T(63)$ . The computer puts the 'times 2' and the 'plus 1' aside for a moment to do that. It computes  $T(63)$  by using this same piece of code (that's what 'recursive' means), and to do that it wants to compute  $2 * T(62) - 1$ . This keeps up (the next step is to try to do  $T(62)$  while it holds the other arithmetic in waiting), until after 63 steps the computer tries to compute  $T(1)$ . It then returns  $T(1) = 1$ , which allows the computation of  $T(2)$  can proceed, etc., up until the original computation of  $T(64)$  finishes.)

The next routine calculates a table of the first few values. (Some language notes: '()' is the empty list, that is, the empty sequence, and cons pushes something onto the start of a list. Note that, in the last line, the procedure proc is called on argument n.)



```
(define (first-few-outputs proc n)
  (first-few-outputs-helper proc n '()) )
;
(define (first-few-outputs-aux proc n lst)
  (if (< n 1)
      lst
      (first-few-outputs-aux proc (- n 1) (cons (proc n) lst)) ) )
```

The session at the SCM prompt went like this.

```
>(first-few-outputs tower-of-hanoi-moves 64)
(1 3 7 15 31 63 127 255 511 1023 2047 4095 8191 16383 32767
65535 131071 262143 524287 1048575 2097151 4194303 8388607
16777215 33554431 67108863 134217727 268435455 536870911
1073741823 2147483647 4294967295 8589934591 17179869183
34359738367 68719476735 137438953471 274877906943 549755813887
1099511627775 2199023255551 4398046511103 8796093022207
17592186044415 35184372088831 70368744177663 140737488355327
281474976710655 562949953421311 1125899906842623
2251799813685247 4503599627370495 9007199254740991
18014398509481983 36028797018963967 72057594037927935
144115188075855871 288230376151711743 576460752303423487
1152921504606846975 2305843009213693951 4611686018427387903
9223372036854775807 18446744073709551615)
```

This is a list of  $T(1)$  through  $T(64)$ .

# Appendix

---

Mathematics is made of arguments (reasoned discourse that is, not crockery-throwing). This section sketches the background material and argument techniques that we use in the book.

This section only outlines these topics, giving an example or two and skipping proofs. For more, these are classics: [Polya], [Quine], and [Halmos74]. [Beck] is a recent book available online.

## Propositions

The point at issue in an argument is the *proposition*. Mathematicians usually write the point in full before the proof and label it either *Theorem* for major points, *Corollary* for points that follow immediately from a prior one, or *Lemma* for when it is chiefly used to prove other results.

The statements expressing propositions can be complex, with many subparts. The truth or falsity of the entire proposition depends both on the truth value of the parts and on how the statement is put together.

**Not** Where  $P$  is a proposition, 'it is not the case that  $P$ ' is true provided that  $P$  is false. Thus, 'n is not prime' is true only when  $n$  is the product of smaller integers.

So 'not' operates on statements, inverting their truth value. We can picture it with a *Venn diagram*.

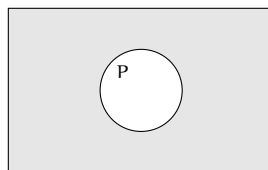

Where the box encloses all natural numbers, and inside the circle are the primes, the shaded area holds numbers satisfying 'not  $P$ '.

To prove that a 'not  $P$ ' statement holds, show that  $P$  is false.

**And** Consider the statement form ' $P$  and  $Q$ '. For it to be true both halves must hold: '7 is prime and so is 3' is true, while '7 is prime and 3 is not' is false.

Here is the Venn diagram for ' $P$  and  $Q$ '.

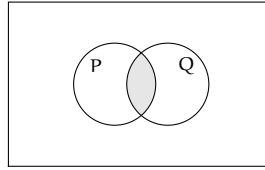

To prove ‘P and Q’, prove that each half holds.

**Or** A ‘P or Q’ statement is true when either half holds: ‘7 is prime or 4 is prime’ is true, while ‘7 is not prime or 4 is prime’ is false. We take ‘or’ to mean that if both halves are true ‘7 is prime or 4 is not’ then the statement as a whole is true. (This is inclusive or. Occasionally in everyday speech people use ‘or’ in an exclusive way — “Live free or die” does not intend both halves to hold — but we will not use ‘or’ in that way.)

The Venn diagram includes all of both circles.

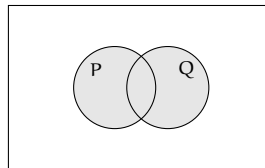

To prove ‘P or Q’, show that in all cases at least one half holds (perhaps sometimes one half and sometimes the other, but always at least one).

**If-then** An ‘if P then Q’ statement (sometimes stated as ‘P implies Q’ or ‘ $P \implies Q$ ’ or ‘P is sufficient to give Q’ or ‘Q if P’) is true unless P is true while Q is false.

There is a fine point here — ‘if P then Q’ is true when P is false, no matter what value Q has: ‘if 4 is prime then 7 is prime’ and ‘if 4 is prime then 7 is not’ are both true statements. (They are *vacuously true*.) Further, ‘if P then Q’ is true when Q is true, no matter what value P has: ‘if 4 is prime then 7 is prime’ and ‘if 4 is not prime then 7 is prime’ are both true.

We adopt this definition of implication because we want statements such as ‘if n is a perfect square then n is not prime’ to be true no matter which number n appears in that statement. For instance, we want ‘if 5 is a perfect square then 5 is not prime’ to be true so we want that if both P and Q are false then  $P \implies Q$  is true.

The diagram

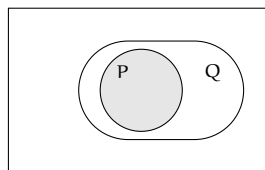

shows that Q holds whenever P does. Notice again that if P does not hold then Q may or may not be in force.

There are two main ways to establish an implication. The first way is direct: assume that  $P$  is true and use that assumption to prove  $Q$ . For instance, to show ‘if a number is divisible by 5 then twice that number is divisible by 10’, assume that the number is  $5n$  and deduce that  $2(5n) = 10n$ . The second way is indirect: prove the *contrapositive* statement: ‘if  $Q$  is false then  $P$  is false’ (rephrased, ‘ $Q$  can only be false when  $P$  is also false’). Thus to show ‘if a number is prime then it is not a perfect square’, we can argue that if it were a square  $p = n^2$  then it could be factored  $p = n \cdot n$  where  $n < p$  and so wouldn’t be prime ( $p = 0$  or  $p = 1$  don’t give  $n < p$  but they are nonprime).

Note two things about this statement form.

First, an ‘if  $P$  then  $Q$ ’ result can sometimes be improved by weakening  $P$  or strengthening  $Q$ . Thus, ‘if a number is divisible by  $p^2$  then its square is also divisible by  $p^2$ ’ could be upgraded either by relaxing its hypothesis: ‘if a number is divisible by  $p$  then its square is divisible by  $p^2$ ’, or by tightening its conclusion: ‘if a number is divisible by  $p^2$  then its square is divisible by  $p^4$ ’.

Second, after showing ‘if  $P$  then  $Q$ ’ then a good next step is to look into whether there are cases where  $Q$  holds but  $P$  does not. The idea is to better understand the relationship between  $P$  and  $Q$  with an eye toward strengthening the proposition.

**Equivalence** An if-then statement cannot be improved when not only does  $P$  imply  $Q$  but also  $Q$  implies  $P$ . Some ways to say this are: ‘ $P$  if and only if  $Q$ ’, ‘ $P$  iff  $Q$ ’, ‘ $P$  and  $Q$  are logically equivalent’, ‘ $P$  is necessary and sufficient to give  $Q$ ’, ‘ $P \iff Q$ ’. An example is ‘a number is divisible by a prime if and only if that number squared is divisible by the prime squared’.

The picture shows that  $P$  and  $Q$  hold in exactly the same cases.

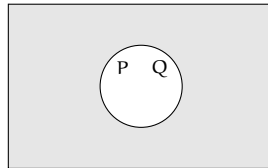

Although in simple arguments a chain like “ $P$  if and only if  $R$ , which holds if and only if  $S \dots$ ” may be practical, typically we show equivalence by showing the two halves ‘if  $P$  then  $Q$ ’ and ‘if  $Q$  then  $P$ ’ separately.

## Quantifiers

Compare these statements about natural numbers: ‘there is an  $x$  such that  $x$  is divisible by  $x^2$ ’ is true, while ‘for all numbers  $x$ , that  $x$  is divisible by  $x^2$ ’ is false. The ‘there is’ and ‘for all’ prefixes are *quantifiers*.

**For all** The ‘for all’ prefix is the *universal quantifier*, symbolized  $\forall$ .

In a sense the box we draw to border the Venn diagram shows the universal quantifier since it delineates the universe of possible members.

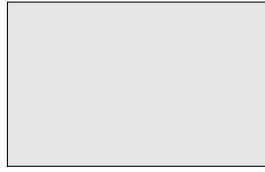

To prove that a statement holds in all cases, show that it holds in each case. Thus to prove that ‘every number divisible by  $p$  has its square divisible by  $p^2$ ’, take a single number of the form  $pn$  and square it  $(pn)^2 = p^2n^2$ . This is a “typical element” or “generic element” proof.

In this kind of argument we must be careful not to assume properties for that element other than those in the hypothesis. Here is an example of a common wrong argument: “if  $n$  is divisible by a prime, say 2, so that  $n = 2k$  for some natural number  $k$ , then  $n^2 = (2k)^2 = 4k^2$  and the square of  $n$  is divisible by the square of the prime.” That is an argument about the case  $p = 2$  but it isn’t a proof for general  $p$ . Contrast it with a correct one: “if  $n$  is divisible by a prime so that  $n = pk$  for some natural number  $k$ , then  $n^2 = (pk)^2 = p^2k^2$  and so the square of  $n$  is divisible by the square of the prime.”

**There exists** The ‘there exists’ prefix is the *existential quantifier*, symbolized  $\exists$ .

A Venn diagram of ‘there is a number such that  $P$ ’ shows both that there can be more than one and also that not all numbers need satisfy  $P$ .

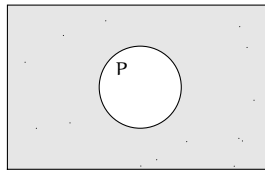

We can prove an existence proposition by producing something satisfying the property: once, to settle the question of primality of  $2^{2^5} + 1$ , Euler produced the divisor 641 [Sandifer]. But there are proofs showing that something exists without saying how to find it; Euclid’s argument given in the next subsection shows there are infinitely many primes without giving a formula naming them. In general, while demonstrating existence is better than nothing, giving an example is better, and an exhaustive list of all instances is ideal.

Finally, along with “Are there any?” we often ask “How many?” So the question of uniqueness often arises in conjunction with questions of existence. Many times the two arguments are simpler if separated, so note that just as proving something exists does not show it is unique, neither does proving something is unique show that it exists. (Obviously ‘the natural number halfway between three and four’ would be unique, but no such number exists.)

## Techniques of Proof

**Induction** Many proofs are iterative, “Here’s why the statement is true for the number 1, it then follows for 2 and from there to 3 ...”. These are proofs by

*induction.* Such a proof has two steps. In the *base step* the proposition is established for some first number, often 0 or 1. In the *inductive step* we show that if the proposition holds for numbers up to and including some  $k$  then holds for the next number  $k + 1$ .

Here is an example proving that  $1 + 2 + 3 + \dots + n = n(n + 1)/2$ .

For the base step we show that the formula holds when  $n = 1$ . That's easy, the sum of the first 1 number does indeed equal  $1(1 + 1)/2$ .

For the inductive step, assume that the formula holds for the numbers  $1, 2, \dots, k$  with  $k \geq 1$ . That is, assume all of these instances of the formula.

$$\begin{aligned} 1 &= 1(1 + 1)/2 \\ \text{and } 1 + 2 &= 2(2 + 1)/2 \\ \text{and } 1 + 2 + 3 &= 3(3 + 1)/2 \\ &\vdots \\ \text{and } 1 + \dots + k &= k(k + 1)/2 \end{aligned}$$

This is the *induction hypothesis*. With this assumption we will deduce that the formula also holds in the  $k + 1$  next case.

$$1 + 2 + \dots + k + (k + 1) = \frac{k(k + 1)}{2} + (k + 1) = \frac{(k + 1)(k + 2)}{2}$$

(The first equality follows from the induction hypothesis.)

We've shown in the base case that the proposition holds for 1. We've shown in the inductive step that if it holds for the case of 1 then it also holds for 2; therefore it does hold for 2. We've also shown in the inductive step that if the statement holds for the cases of 1 and 2 then it also holds for the next case 3. Continuing in this way, we get that the statement holds for any natural number greater than or equal to 1.

Here is another example, proving proof that every integer greater than 1 is a product of primes.

The base step is easy: 2 is the product of a single prime.

For the inductive step assume that each of  $2, 3, \dots, k$  is a product of primes, aiming to show  $k + 1$  is also a product of primes. There are two possibilities. First, if  $k + 1$  is not divisible by a number smaller than itself then it is a prime and so is the product of primes. The second possibility is that  $k + 1$  is divisible by a number smaller than itself, and then its factors can be written as a product of primes by the inductive hypothesis. In either case  $k + 1$  can be rewritten as a product of primes.

There are two things to note about the 'next number' in an induction argument. One thing is that while induction works on the integers, it's no good on the reals since there is no 'next' real. The other thing is that we sometimes use induction to go down, say, from 10 to 9 to 8, etc., down to 0. So 'next number' could mean 'next lowest number'. Of course, at the end we have not shown the fact for all natural numbers, only for those less than or equal to 10.

**Contradiction** Another technique of proof is to show that something is true by showing that it cannot be false.

The classic example of proof by contradiction is Euclid's argument that there are infinitely many primes.

Suppose there are only finitely many primes  $p_1, \dots, p_k$ . Consider  $p_1 \cdot p_2 \dots p_k + 1$ . None of the primes on this supposedly exhaustive list divides that number evenly since each leaves a remainder of 1. But every number is a product of primes so this can't be. Therefore there cannot be only finitely many primes.

Every proof by contradiction assumes that the proposition is false and derives some contradiction to known facts. Another example is this proof that  $\sqrt{2}$  is not a rational number.

Suppose that  $\sqrt{2} = m/n$ .

$$2n^2 = m^2$$

Factor out any 2's, giving  $n = 2^{k_n} \cdot \hat{n}$  and  $m = 2^{k_m} \cdot \hat{m}$ . Rewrite.

$$2 \cdot (2^{k_n} \cdot \hat{n})^2 = (2^{k_m} \cdot \hat{m})^2$$

The Prime Factorization Theorem says that there must be the same number of factors of 2 on both sides, but there are an odd number of them  $1 + 2k_n$  on the left and an even number of them  $2k_m$  on the right. That's a contradiction, so a rational with a square of 2 is impossible.

Both of these examples aimed to prove something doesn't exist. A negative proposition often suggests a proof by contradiction.

## Sets, Functions, and Relations

**Sets** Mathematicians work with collections, called *sets*. A set can be given as a listing between curly braces as in  $\{1, 4, 9, 16\}$ , or if that's unwieldy, by using set-builder notation as in  $\{x \mid x^5 - 3x^3 + 2 = 0\}$  (read "the set of all  $x$  such that ..."). We name sets with capital roman letters, as with the primes  $P = \{2, 3, 5, 7, 11, \dots\}$ , except for a few special sets such as the real numbers  $\mathbb{R}$  and the complex numbers  $\mathbb{C}$ . To denote that something is an *element* (or *member*) of a set we use ' $\in$ ', so that  $7 \in \{3, 5, 7\}$  while  $8 \notin \{3, 5, 7\}$ .

Sets satisfy the Principle of Extensionality, that two sets with the same elements are equal. Because of this, repeats collapse  $\{7, 7\} = \{7\}$  and order doesn't matter  $\{2, \pi\} = \{\pi, 2\}$ .

We say that  $A$  is a *subset* of  $B$ , written  $A \subseteq B$ , if any element of  $A$  is an element of  $B$ . We use ' $\subset$ ' for the *proper subset* relationship that  $A$  is a subset of  $B$  but  $A \neq B$ . An example is  $\{2, \pi\} \subset \{2, \pi, 7\}$ . These symbols may be flipped, for instance  $\{2, \pi, 5\} \supset \{2, 5\}$ .

Because of Extensionality, to prove that two sets are equal  $A = B$ , show that they have the same members. Usually we show mutual inclusion, that both  $A \subseteq B$  and  $A \supseteq B$ .

When a set has no members then it is the *empty set*  $\{\}$ , symbolized  $\emptyset$ . Any set has the empty set for a subset, by the ‘vacuously true’ property of the definition of implication.

**Set operations** Venn diagrams are handy here. For instance, we can picture  $x \in P$

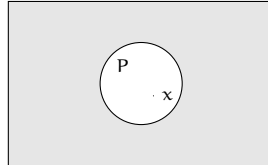

and ‘ $P \subseteq Q$ ’.

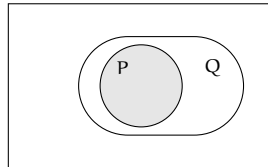

This is a repeat of the diagram for ‘if ... then ...’ because ‘ $P \subseteq Q$ ’ means ‘if  $x \in P$  then  $x \in Q$ ’.

For every propositional logic operator there is an associated set operator. The *complement* of  $P$  is  $P^{\text{comp}} = \{x \mid \text{not}(x \in P)\}$

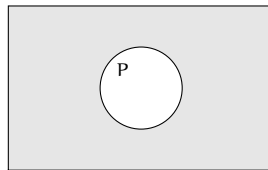

the *union* is  $P \cup Q = \{x \mid (x \in P) \text{ or } (x \in Q)\}$

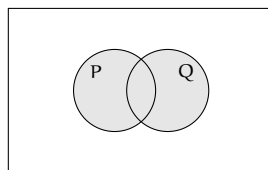

and the *intersection* is  $P \cap Q = \{x \mid (x \in P) \text{ and } (x \in Q)\}$ .

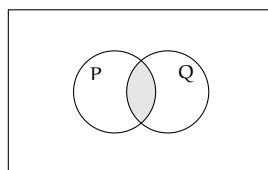



**Sequences** In addition to sets, we also use collections where order matters and where repeats do not collapse. These are *sequences*, denoted with angle brackets:  $\langle 2, 3, 7 \rangle \neq \langle 2, 7, 3 \rangle$ . A sequence of length 2 is an *ordered pair*, and is often written with parentheses:  $(\pi, 3)$ . We also sometimes say ‘ordered triple’, ‘ordered 4-tuple’, etc. The set of ordered  $n$ -tuples of elements of a set  $A$  is denoted  $A^n$ . Thus  $\mathbb{R}^2$  is the set of pairs of reals.

**Functions** When we first learn about functions they are presented as formulas such as  $f(x) = 16x^2 - 100$ . But progressing to more advanced mathematics reveals more general functions—trigonometric ones, exponential and logarithmic ones, and even constructs like absolute value that involve piecing together parts. And some functions take inputs that are not numbers: the function that returns the  $\mathbb{R}^2$  distance from a point to the origin  $\sqrt{x^2 + y^2}$  takes the ordered pair  $(x, y)$  as its argument. So we see that functions aren’t formulas, instead the key idea is that a function associates with each input  $x$  a single output  $f(x)$ .

Consequently, a *function* or *map* is defined to be a set of ordered pairs  $(x, f(x))$  such that  $x$  suffices to determine  $f(x)$ . Restated, that is: if  $x_1 = x_2$  then  $f(x_1) = f(x_2)$  (this is the requirement that a function must be *well-defined*)\*.

Each input  $x$  is one of the function’s *arguments*. Each output  $f(x)$  is a *value* (often where  $x$  is the input the output is denoted  $y$ ). The set of all arguments is  $f$ ’s *domain* and the set of output values is its *range*. Usually we don’t need to know what is and is not in the range and we instead work with a convenient superset of the range, the *codomain*. The notation for a function  $f$  with domain  $X$  and codomain  $Y$  is  $f: X \rightarrow Y$ .

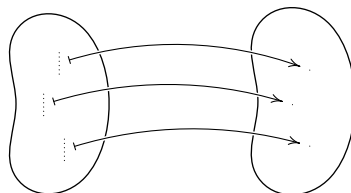

We also use the notation  $x \xrightarrow{f} 16x^2 - 100$ , read ‘ $x$  maps under  $f$  to  $16x^2 - 100$ ’ or ‘ $16x^2 - 100$  is the *image* of  $x$ ’.

A map such as  $x \mapsto \sin(1/x)$  is a combinations of simple maps, here  $g(y) = \sin(y)$  applied to the image of  $f(x) = 1/x$ . The *composition* of  $g: Y \rightarrow Z$  with  $f: X \rightarrow Y$ , is the map sending  $x \in X$  to  $g(f(x)) \in Z$ . It is denoted  $g \circ f: X \rightarrow Z$ . This definition only makes sense if the range of  $f$  is a subset of the domain of  $g$ .

An *identity map*  $\text{id}: Y \rightarrow Y$  defined by  $\text{id}(y) = y$  has the property that for any  $f: X \rightarrow Y$ , the composition  $\text{id} \circ f$  is equal to  $f$ . So an identity map plays the same role with respect to function composition that the number 0 plays in real number addition or that 1 plays in multiplication.

In line with that analogy, we define a *left inverse* of a map  $f: X \rightarrow Y$  to be a function  $g: \text{range}(f) \rightarrow X$  such that  $g \circ f$  is the identity map on  $X$ . A *right inverse* of  $f$  is a  $h: Y \rightarrow X$  such that  $f \circ h$  is the identity.

\*More on this is in the section on isomorphisms

A map that is both a left and right inverse of  $f$  is called simply an *inverse*. An inverse, if one exists, is unique because if both  $g_1$  and  $g_2$  are inverses of  $f$  then  $g_1(x) = g_1 \circ (f \circ g_2)(x) = (g_1 \circ f) \circ g_2(x) = g_2(x)$  (the middle equality comes from the associativity of function composition), so we often call it “the” inverse, written  $f^{-1}$ . For instance, the inverse of the function  $f: \mathbb{R} \rightarrow \mathbb{R}$  given by  $f(x) = 2x - 3$  is the function  $f^{-1}: \mathbb{R} \rightarrow \mathbb{R}$  given by  $f^{-1}(x) = (x + 3)/2$ .

The superscript ‘ $f^{-1}$ ’ notation for function inverse can be confusing since it clashes with  $1/f(x)$ . But it fits into a larger scheme. Functions that have the same codomain as domain can be iterated, so that where  $f: X \rightarrow X$ , we can consider the composition of  $f$  with itself:  $f \circ f$ , and  $f \circ f \circ f$ , etc. We write  $f \circ f$  as  $f^2$  and  $f \circ f \circ f$  as  $f^3$ , etc. Note that the familiar exponent rules for real numbers hold:  $f^i \circ f^j = f^{i+j}$  and  $(f^i)^j = f^{i \cdot j}$ . Then where  $f$  is invertible, writing  $f^{-1}$  for the inverse and  $f^{-2}$  for the inverse of  $f^2$ , etc., gives that these familiar exponent rules continue to hold, once we define  $f^0$  to be the identity map.

If the codomain  $Y$  equals the range of  $f$  then we say that the function is *onto*. A function has a right inverse if and only if it is onto (this is not hard to check). If no two arguments share an image, if  $x_1 \neq x_2$  implies that  $f(x_1) \neq f(x_2)$ , then the function is *one-to-one*. A function has a left inverse if and only if it is one-to-one (this is also not hard to check).

By the prior paragraph, a map has an inverse if and only if it is both onto and one-to-one. Such a function is a *correspondence*. It associates one and only one element of the domain with each element of the range. Because a composition of one-to-one maps is one-to-one, and a composition of onto maps is onto, a composition of correspondences is a correspondence.

We sometimes want to shrink the domain of a function. For instance, we may take the function  $f: \mathbb{R} \rightarrow \mathbb{R}$  given by  $f(x) = x^2$  and, in order to have an inverse, limit input arguments to nonnegative reals  $\hat{f}: \mathbb{R}^+ \rightarrow \mathbb{R}$ . Then  $\hat{f}$  is a different function than  $f$ ; we call it the *restriction* of  $f$  to the smaller domain.

**Relations** For some familiar operations we most naturally interpret them as functions: addition maps  $(5, 3)$  to 8. But what of ‘ $<$ ’ or ‘ $=$ ’? We can take the approach of rephrasing ‘ $3 < 5$ ’ to ‘ $(3, 5)$  is in the relation  $<$ ’. That is, define a *binary relation* on a set  $A$  to be a set of ordered pairs of elements of  $A$ . For example, the  $<$  relation is the set  $\{(a, b) \mid a < b\}$ ; some elements of that set are  $(3, 5)$ ,  $(3, 7)$ , and  $(1, 100)$ .

Another binary relation on the natural numbers is equality; this relation is the set  $\{\dots, (-1, -1), (0, 0), (1, 1), \dots\}$ . Still another example is ‘closer than 10’, the set  $\{(x, y) \mid |x - y| < 10\}$ . Some members of that relation are  $(1, 10)$ ,  $(10, 1)$ , and  $(42, 44)$ . Neither  $(11, 1)$  nor  $(1, 11)$  is a member.

Those examples illustrate the generality of the definition. All kinds of relationships (e.g., ‘both numbers even’ or ‘first number is the second with the digits reversed’) are covered.

**Equivalence Relations** We shall need to express that two objects are alike in some way. They aren’t identical, but they are related (e.g., two integers that

‘give the same remainder when divided by 2’).

A binary relation  $\{(a, b), \dots\}$  is an *equivalence relation* when it satisfies (1) *reflexivity*: any object is related to itself, (2) *symmetry*: if  $a$  is related to  $b$  then  $b$  is related to  $a$ , and (3) *transitivity*: if  $a$  is related to  $b$  and  $b$  is related to  $c$  then  $a$  is related to  $c$ . Some examples (on the integers): ‘=’ is an equivalence relation, ‘<’ does not satisfy symmetry, ‘same sign’ is a equivalence, while ‘nearer than 10’ fails transitivity.

**Partitions** In the ‘same sign’ relation  $\{(1, 3), (-5, -7), (-1, -1), \dots\}$  there are two kinds of pairs, the ones with both numbers positive and those with both negative. So integers fall into exactly one of two classes, positive or negative.

A *partition* of a set  $S$  is a collection of subsets  $\{S_0, S_1, S_2, \dots\}$  such that every element of  $S$  is in one and only one subset:  $S_1 \cup S_2 \cup \dots = S$ , and if  $i \neq j$  then  $S_i \cap S_j = \emptyset$ . Picture that  $S$  is decomposed into non-overlapping parts.

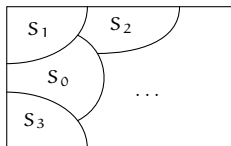

Thus, the first paragraph says ‘same sign’ partitions the integers into the positives and the negatives. Similarly, the equivalence relation ‘=’ partitions the integers into one-element sets.

An example is the set of fractions  $S = \{n/d \mid n, d \in \mathbb{Z} \text{ and } d \neq 0\}$ . We define two members  $n_1/d_1$  and  $n_2/d_2$  of  $S$  to be equivalent if  $n_1 d_2 = n_2 d_1$ . We can check that this is an equivalence relation, that it satisfies the above three conditions. So  $S$  is partitioned.

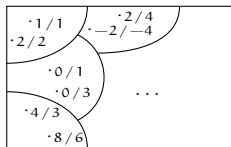

Every equivalence relation induces a partition, and every partition is induced by an equivalence. (This is routine to check.) Below are two examples.

Consider the equivalence relationship between two integers of ‘give the same remainder when divided by 2’, the set  $P = \{(-1, 3), (2, 4), (0, 0), \dots\}$  (this is more briefly stated as ‘same parity’). In the set  $P$  are two kinds of pairs, the ones with both members even and the ones with both members odd. This equivalence induces a partition where the parts are found by: for each  $x$  we define the set of numbers related to it  $S_x = \{y \mid (x, y) \in P\}$ . Some parts are  $S_1 = \{\dots, -3, -1, 1, 3, \dots\}$ , and  $S_2 = \{\dots, -2, 0, 2, 4, \dots\}$ , and  $S_{-1} = \{\dots, -3, -1, 1, 3, \dots\}$ . Note that there are only two parts; for instance  $S_1 = S_{-1}$  is the odd numbers and  $S_2 = S_4$  is the evens.

Now consider the partition of the natural numbers where two numbers are in the same part if they leave the same remainder when divided by 10, that is,

if they have the same least significant digit. This partition is induced by the equivalence relation  $R$  defined by: two numbers  $n, m$  are related if they are together in the same part. The three conditions in the definition of equivalence are straightforward. For example, 3 is related to 33, but 3 is not related to 102.

We call each part of a partition an *equivalence class*. We sometimes pick a single element of each equivalence class to be the *class representative*.

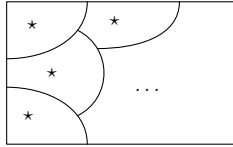

Usually when we pick representatives we have some natural scheme in mind. In that case we call them the *canonical* representatives.

An example is the simplest form of a fraction. The two fractions  $3/5$  and  $9/15$  are equivalent. In everyday work we often prefer to use the 'simplest form' or 'reduced form' fraction  $3/5$  as the class representatives.

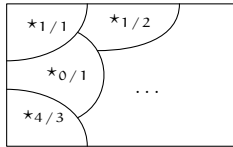



# Bibliography

---

- [Abbot] Edwin Abbott, *Flatland*, Dover.
- [Ackerson] R. H. Ackerson, *A Note on Vector Spaces*, American Mathematical Monthly, vol. 62 no. 10 (Dec. 1955), p. 721.
- [Agnew] Jeanne Agnew, *Explorations in Number Theory*, Brooks/Cole, 1972.
- [Am. Math. Mon., Jun. 1931] C. A. Rupp (proposer), H. T. R. Aude (solver), problem 3468, American Mathematical Monthly, vol. 37 no. 6 (June-July 1931), p. 355.
- [Am. Math. Mon., Feb. 1933] V. F. Ivanoff (proposer), T. C. Esty (solver), problem 3529, American Mathematical Monthly, vol. 39 no. 2 (Feb. 1933), p. 118.
- [Am. Math. Mon., Jan. 1935] W. R. Ransom (proposer), Hansraj Gupta (solver), Elementary problem 105, American Mathematical Monthly, vol. 42 no. 1 (Jan. 1935), p. 47.
- [Am. Math. Mon., Jan. 1949] C. W. Trigg (proposer), R. J. Walker (solver), Elementary problem 813, American Mathematical Monthly, vol. 56 no. 1 (Jan. 1949), p. 33.
- [Am. Math. Mon., Jun. 1949] Don Walter (proposer), Alex Tytun (solver), Elementary problem 834, American Mathematical Monthly, vol. 56 no. 6 (June-July 1949), p. 409.
- [Am. Math. Mon., Nov. 1951] Albert Wilansky, *The Row-Sums of the Inverse Matrix*, American Mathematical Monthly, vol. 58 no. 9 (Nov. 1951), p. 614.
- [Am. Math. Mon., Feb. 1953] Norman Anning (proposer), C. W. Trigg (solver), Elementary problem 1016, American Mathematical Monthly, vol. 60 no. 2 (Feb. 1953), p. 115.
- [Am. Math. Mon., Apr. 1955] Vern Haggett (proposer), F. W. Saunders (solver), Elementary problem 1135, American Mathematical Monthly, vol. 62 no. 4 (Apr. 1955), p. 257.
- [Am. Math. Mon., Jan. 1963] Underwood Dudley, Arnold Lebow (proposers), David Rothman (solver), Elementary problem 1151, American Mathematical Monthly, vol. 70 no. 1 (Jan. 1963), p. 93.
- [Am. Math. Mon., Dec. 1966] Hans Liebeck, *A Proof of the Equality of Column Rank and Row Rank of a Matrix* American Mathematical Monthly, vol. 73 no. 10 (Dec. 1966), p. 1114.
- [Anton] Howard Anton, *Elementary Linear Algebra*, John Wiley & Sons, 1987.

- [Arrow] Kenneth J. Arrow, *Social Choice and Individual Values*, Wiley, 1963.
- [Austin] David Austin, *How Google Finds Your Needle in the Web's Haystack*, <http://www.ams.org/samplings/feature-column/fcarc-pagerank>, retrieved Feb. 2012.
- [Ball & Coxeter] W.W. Rouse Ball, *Mathematical Recreations and Essays*, revised by H.S.M. Coxeter, MacMillan, 1962.
- [Beck] Matthias Beck, Ross Geoghegan, *The Art of Proof*, <http://math.sfsu.edu/beck/papers/aop.noprint.pdf>, 2011-Aug-08.
- [Beardon] A.F. Beardon, *The Dimension of the Space of Magic Squares*, *The Mathematical Gazette*, vol. 87, no. 508 (Mar. 2003), p. 112-114.
- [Birkhoff & MacLane] Garrett Birkhoff, Saunders MacLane, *Survey of Modern Algebra*, third edition, Macmillan, 1965.
- [Blass 1984] A. Blass, *Existence of Bases Implies the Axiom of Choice*, pp. 31–33, *Axiomatic Set Theory*, J. E. Baumgartner, ed., American Mathematical Society, Providence RI, 1984.
- [Bridgman] P.W. Bridgman, *Dimensional Analysis*, Yale University Press, 1931.
- [Brin & Page] Sergey Brin and Lawrence Page, *The Anatomy of a Large-Scale Hypertextual Web Search Engine*, <http://infolab.stanford.edu/pub/papers/google.pdf>, retrieved Feb. 2012.
- [Bryan & Leise] Kurt Bryan, Tanya Leise, *The \$25,000,000,000 Eigenvector: the Linear Algebra Behind Google*, *SIAM Review*, Vol. 48, no. 3 (2006), p. 569-81.
- [Casey] John Casey, *The Elements of Euclid, Books I to VI and XI*, ninth edition, Hodges, Figgis, and Co., Dublin, 1890.
- [Clark & Coupe] David H. Clark, John D. Coupe, *The Bangor Area Economy Its Present and Future*, report to the city of Bangor ME, Mar. 1967.
- [Cleary] R. Cleary, private communication, Nov. 2011.
- [Clarke] Arthur C. Clarke, *Technical Error*, *Fantasy*, December 1946, reprinted in *Great SF Stories 8* (1946), DAW Books, 1982.
- [Con. Prob. 1955] *The Contest Problem Book*, 1955 number 38.
- [Cost Of Tolls] *Cost of Tolls*, [http://costoftolls.com/Tolls\\_in\\_New\\_York.html](http://costoftolls.com/Tolls_in_New_York.html), 2012-Jan-07.
- [Coxeter] H.S.M. Coxeter, *Projective Geometry*, second edition, Springer-Verlag, 1974.
- [Courant & Robbins] Richard Courant, Herbert Robbins, *What is Mathematics?*, Oxford University Press, 1978.
- [Cullen] Charles G. Cullen, *Matrices and Linear Transformations*, second edition, Dover, 1990.
- [Dalal, et. al.] Siddhartha R. Dalal, Edward B. Fowlkes, & Bruce Hoadley, *Lesson Learned from Challenger: A Statistical Perspective*, *Stats: the Magazine for Students of Statistics*, Fall 1989, p. 3.
- [Davies] Thomas D. Davies, *New Evidence Places Peary at the Pole*, *National Geographic Magazine*, vol. 177 no. 1 (Jan. 1990), p. 44.
- [de Mestre] Neville de Mestre, *The Mathematics of Projectiles in Sport*, Cambridge University Press, 1990.

- [De Parville] De Parville, *La Nature*, Paris, 1884, part I, p. 285–286 (citation from [Ball & Coxeter]).
- [Duncan] W.J. Duncan, *Method of Dimensions*, in *Encyclopaedic Dictionary of Physics* Macmillan, 1962.
- [Ebbing] Darrell D. Ebbing, *General Chemistry*, fourth edition, Houghton Mifflin, 1993.
- [Ebbinghaus] H. D. Ebbinghaus, *Numbers*, Springer-Verlag, 1990.
- [Einstein] A. Einstein, *Annals of Physics*, v. 35, 1911, p. 686.
- [Eggar] M.H. Eggar, *Pinhole Cameras, Perspective, and Projective Geometry*, *American Mathematical Monthly*, August-September 1998, p. 618–630.
- [Falbo] Clement Falbo, *The Golden Ratio — a Contrary Viewpoint*, *College Mathematics Journal*, vol. 36, no. 2, March 2005, p. 123–134.
- [Feller] William Feller, *An Introduction to Probability Theory and Its Applications* (vol. 1, 3rd ed.), John Wiley, 1968.
- [Federal Reserve] Federal Reserve Bank of Richmond, *FAQs Currency and Coin*, <http://www.richmondfed.org/faqs/currency/> Jan 2012.
- [Finkbeiner] Daniel T. Finkbeiner III, *Introduction to Matrices and Linear Transformations*, third edition, W. H. Freeman and Company, 1978.
- [Fraleigh & Beauregard] Fraleigh & Beauregard, *Linear Algebra*.
- [Gardner] Martin Gardner, *The New Ambidextrous Universe*, third revised edition, W. H. Freeman and Company, 1990.
- [Gardner 1957] Martin Gardner, *Mathematical Games: About the remarkable similarity between the Icosian Game and the Tower of Hanoi*, *Scientific American*, May 1957, p. 150–154.
- [Gardner, 1970] Martin Gardner, *Mathematical Games, Some mathematical curiosities embedded in the solar system*, *Scientific American*, April 1970, p. 108–112.
- [Gardner, 1980] Martin Gardner, *Mathematical Games, From counting votes to making votes count: the mathematics of elections*, *Scientific American*, October 1980.
- [Gardner, 1974] Martin Gardner, *Mathematical Games, On the paradoxical situations that arise from nontransitive relations*, *Scientific American*, October 1974.
- [Giordano, Wells, Wilde] Frank R. Giordano, Michael E. Wells, Carroll O. Wilde, *Dimensional Analysis*, UMAP Unit 526, in *UMAP Modules, 1987*, COMAP, 1987.
- [Giordano, Jaye, Weir] Frank R. Giordano, Michael J. Jaye, Maurice D. Weir, *The Use of Dimensional Analysis in Mathematical Modeling*, UMAP Unit 632, in *UMAP Modules, 1986*, COMAP, 1986.
- [Glazer] A.M. Glazer, *The Structure of Crystals*, Adam Hilger, 1987.
- [Google Maps] *Directions — Google Maps*, <http://maps.google.com/help/maps/directions/>, 2012-Jan-07.
- [Goult, et al.] R.J. Goult, R.F. Hoskins, J.A. Milner, M.J. Pratt, *Computational Methods in Linear Algebra*, Wiley, 1975.



- [Graham, Knuth, Patashnik] Ronald L. Graham, Donald E. Knuth, Oren Patashnik, *Concrete Mathematics*, Addison-Wesley, 1988.
- [Halmos] Paul R. Halmos, *Finite Dimensional Vector Spaces*, second edition, Van Nostrand, 1958.
- [Halmos74] Paul R. Halmos, *Naive Set Theory*, Springer-Verlag, 1974.
- [Hamming] Richard W. Hamming, *Introduction to Applied Numerical Analysis*, Hemisphere Publishing, 1971.
- [Hanes] Kit Hanes, *Analytic Projective Geometry and its Applications*, UMAP Unit 710, UMAP Modules, 1990, p. 111.
- [Heath] T. Heath, *Euclid's Elements*, volume 1, Dover, 1956.
- [Hoffman & Kunze] Kenneth Hoffman, Ray Kunze, *Linear Algebra*, second edition, Prentice-Hall, 1971.
- [Hofstadter] Douglas R. Hofstadter, *Metamagical Themas: Questing for the Essence of Mind and Pattern*, Basic Books, 1985.
- [Iosifescu] Marius Iosifescu, *Finite Markov Processes and Their Applications*, John Wiley, 1980.
- [Kelton] Christina M.L. Kelton, *Trends on the Relocation of U.S. Manufacturing*, UMI Research Press, 1983.
- [Kemeny & Snell] John G. Kemeny, J. Laurie Snell, *Finite Markov Chains*, D. Van Nostrand, 1960.
- [Kemp] Franklin Kemp *Linear Equations*, American Mathematical Monthly, volume 89 number 8 (Oct. 1982), p. 608.
- [Knuth] Donald E. Knuth, *The Art of Computer Programming*, Addison Wesley, 1988.
- [Lang] Serge Lang, *Linear Algebra*, Addison-Wesley, 1966.
- [Leontief 1951] Wassily W. Leontief, *Input-Output Economics*, Scientific American, volume 185 number 4 (Oct. 1951), p. 15.
- [Leontief 1965] Wassily W. Leontief, *The Structure of the U.S. Economy*, Scientific American, volume 212 number 4 (Apr. 1965), p. 25.
- [Lieberman] David Lieberman, *The Big Bucks Ad Battles Over TV's Most Expensive Minutes*, TV Guide, Jan. 26 1991, p. 11.
- [Macdonald & Ridge] Kenneth Macdonald, John Ridge, *Social Mobility, in British Social Trends Since 1900*, A.H. Halsey, Macmillan, 1988.
- [Macmillan Dictionary] William D. Halsey, Macmillan, 1979.
- [Math. Mag., Sept. 1952] Dewey Duncan (proposer), W. H. Quelch (solver), *Mathematics Magazine*, volume 26 number 1 (Sept-Oct. 1952), p. 48.
- [Math. Mag., Jan. 1957] M. S. Klamkin (proposer), Trickie T-27, *Mathematics Magazine*, volume 30 number 3 (Jan-Feb. 1957), p. 173.
- [Math. Mag., Jan. 1963, Q237] D. L. Silverman (proposer), C. W. Trigg (solver), *Quickie 237*, *Mathematics Magazine*, volume 36 number 1 (Jan. 1963).
- [Math. Mag., Jan. 1963, Q307] C. W. Trigg (proposer). *Quickie 307*, *Mathematics Magazine*, volume 36 number 1 (Jan. 1963), p. 77.

- [Math. Mag., Nov. 1967] Clarence C. Morrison (proposer), Quickie, Mathematics Magazine, volume 40 number 4 (Nov. 1967), p. 232.
- [Math. Mag., Jan. 1973] Marvin Bittinger (proposer), Quickie 578, Mathematics Magazine, volume 46 number 5 (Jan. 1973), p. 286, 296.
- [Munkres] James R. Munkres, *Elementary Linear Algebra*, Addison-Wesley, 1964.
- [Neimi & Riker] Richard G. Neimi, William H. Riker, *The Choice of Voting Systems*, Scientific American, June 1976, p. 21–27.
- [Nering] Evar D. Nering, *Linear Algebra and Matrix Theory*, second edition, John Wiley, 1970.
- [Niven & Zuckerman] I. Niven, H. Zuckerman, *An Introduction to the Theory of Numbers*, third edition, John Wiley, 1972.
- [Oakley & Baker] Cletus O. Oakley, Justine C. Baker, *Least Squares and the 3 : 40 Mile*, Mathematics Teacher, Apr. 1977.
- [Ohanian] Hans O'Hanian, *Physics*, volume one, W. W. Norton, 1985.
- [Onan] Onan, *Linear Algebra*.
- [Online Encyclopedia of Integer Sequences] *Number of different magic squares of order  $n$  that can be formed from the numbers  $1, \dots, n^2$* , <http://oeis.org/A006052>, 2012-Feb-17.
- [Petersen] G. M. Petersen, *Area of a Triangle*, American Mathematical Monthly, volume 62 number 4 (Apr. 1955), p. 249.
- [Polya] G. Polya, *Mathematics and Plausible Reasoning*, Princeton University Press, 1954.
- [Poundstone] W. Poundstone, *Gaming the Vote*, Hill and Wang, 2008. ISBN-13: 978-0-8090-4893-9
- [Putnam, 1988, A-6] William Lowell Putnam Mathematical Competition, Problem A-6, 1988, solution: American Mathematical Monthly, volume 96 number 8 (Oct. 1989), p. 688.
- [Putnam, 1990, A-5] William Lowell Putnam Mathematical Competition, Problem A-5, 1990.
- [Rice] John R. Rice, *Numerical Methods, Software, and Analysis*, second edition, Academic Press, 1993.
- [Quine] W. V. Quine, *Methods of Logic*, fourth edition, Harvard University Press, 1982.
- [Rucker] Rudy Rucker, *Infinity and the Mind*, Birkhauser, 1982.
- [Ryan] Patrick J. Ryan, *Euclidean and Non-Euclidean Geometry: an Analytic Approach*, Cambridge University Press, 1986.
- [Sandifer] Ed Sandifer, *How Euler Did It*, <http://www.maa.org/editorial/euler/How%20Euler%20Did%20It%2041%20factoring%20F5.pdf> (version: 2012-Jan-27).
- [Schmidt] Jack Schmidt <http://math.stackexchange.com/a/98558/12012> (version: 2012-01-12).
- [Shepelev] Anton Shepelev, private communication, Feb 19, 2011.
- [Seidenberg] A. Seidenberg, *Lectures in Projective Geometry*, Van Nostrand, 1962.

- [Smith] Larry Smith, *Linear Algebra*, second edition, Springer-Verlag, 1984.
- [Strang 93] Gilbert Strang *The Fundamental Theorem of Linear Algebra*, American Mathematical Monthly, Nov. 1993, p. 848–855.
- [Strang 80] Gilbert Strang, *Linear Algebra and its Applications*, second edition, Harcourt Brace Jovanovich, 1980.
- [Taylor] Alan D. Taylor, *Mathematics and Politics: Strategy, Voting, Power, and Proof*, Springer-Verlag, 1995.
- [Tilley] Burt Tilley, private communication, 1996.
- [Trono] Tony Trono, compiler, *University of Vermont Mathematics Department High School Prize Examinations 1958-1991*, mimeographed printing, 1991.
- [USSR Olympiad no. 174] *The USSR Mathematics Olympiad*, number 174.
- [Weston] J. D. Weston, *Volume in Vector Spaces*, American Mathematical Monthly, volume 66 number 7 (Aug./Sept. 1959), p. 575–577.
- [Ward] James E. Ward III, *Vector Spaces of Magic Squares*, Mathematics Magazine, vol 53 no 2 (Mar 1980), p 108–111.
- [Weyl] Hermann Weyl, *Symmetry*, Princeton University Press, 1952.
- [Wickens] Thomas D. Wickens, *Models for Behavior*, W.H. Freeman, 1982.
- [Wilkinson 1965] Wilkinson, 1965
- [Wikipedia Lo Shu Square] *Lo Shu Square*, [http://en.wikipedia.org/wiki/Lo\\_Shu\\_Square](http://en.wikipedia.org/wiki/Lo_Shu_Square), 2012-Feb-17.
- [Wikipedia Magic Square] *Magic square*, [http://en.wikipedia.org/wiki/Magic\\_square](http://en.wikipedia.org/wiki/Magic_square), 2012-Feb-17.
- [Wikipedia Mens Mile] *Mile run world record progression*, [http://en.wikipedia.org/wiki/Mile\\_run\\_world\\_record\\_progression](http://en.wikipedia.org/wiki/Mile_run_world_record_progression), 2011-Apr-09.
- [Wikipedia Square-cube Law] *The Square-cube law*, [http://en.wikipedia.org/wiki/Square-cube\\_law](http://en.wikipedia.org/wiki/Square-cube_law), 2011-Jan-17.
- [Wikipedia Google Page Rank] *Page Rank*, <http://en.wikipedia.org/wiki/PageRank>, 2012-Feb-27.
- [Wills] Rebecca S. Wills, *Google's Page Rank*, Mathematical Intelligencer, vol. 28, no. 4, Fall 2006.
- [Wohascum no. 2] *The Wohascum County Problem Book* problem number 2.
- [Wohascum no. 47] *The Wohascum County Problem Book* problem number 47.
- [Yaglom] I. M. Yaglom, *Felix Klein and Sophus Lie: Evolution of the Idea of Symmetry in the Nineteenth Century*, translated by Sergei Sossinsky, Birkhäuser, 1988.
- [Yuster] Thomas Yuster, *The Reduced Row Echelon Form of a Matrix is Unique: a Simple Proof*, Mathematics Magazine, vol. 57, no. 2 (Mar. 1984), pp. 93-94.
- [Zwicker] William S. Zwicker, *The Voters' Paradox, Spin, and the Borda Count*, Mathematical Social Sciences, vol. 22 (1991), p. 187–227.

# Index

---

- accuracy
  - of Gauss' method, 63–66
  - rounding error, 64
- adding rows, 4
- addition
  - vector, 74
- additive inverse, 74
- adjoint matrix, 322
- angle, 41
- antipodal, 335
- antisymmetric matrix, 132
- argument, A-8
- arrow diagram, 209, 225, 231, 235, 348
- augmented matrix, 14
- automorphism, 157
  - dilation, 157
  - reflection, 157
  - rotation, 157
  
- back-substitution, 5
- base step
  - of induction, A-5
- basis, 106–117
  - change of, 231
  - definition, 106
  - orthogonal, 249
  - orthogonalization, 249
  - orthonormal, 250
  - standard, 107, 347
  - standard over the complex numbers, 347
  - string, 369
- best fit line, 262
- block matrix, 306
- box, 314
  - orientation, 315
  - sense, 316
  - volume, 316
  
- C language, 63
- canonical form
  - for matrix equivalence, 238
  - for nilpotent matrices, 372
  - for row equivalence, 54
  - for similarity, 391
- canonical representative, A-11
- Cauchy-Schwartz Inequality, 40
- Cayley-Hamilton theorem, 380
- central projection, 331
- change of basis, 231–242
- characteristic
  - vectors, values, 354
- characteristic equation, 358
- characteristic polynomial, 358
  - satisfied by, 382
- characteristic root, 362
- characterized, 166
- characterizes, 239
- Chemistry problem, 1, 9
- chemistry problem, 22
- circuits
  - parallel, 68
  - series, 68
  - series-parallel, 69
- class
  - equivalence, A-11
- closure, 89
  - of nullspace, 365
  - of rangespace, 365
- codomain, A-8
- cofactor, 321
- column, 13
  - rank, 119
  - vector, 14
- column rank
  - full, 124
- column space, 119

- combining rows, 4
- complement, A-7
- complementary subspaces, 129
  - orthogonal, 255
- complex numbers, 345
  - vector space over, 84
- component, 14
- composition, A-8
  - self, 363
- computer algebra systems, 57–58
- concatenation, 127
- conditioning number, 65
- congruent figures, 283
- congruent plane figures, 283
- constant polynomial, 344
- contradiction, A-6
- contrapositive, A-3
- convex set, 176
- coordinates
  - homogeneous, 334
  - with respect to a basis, 109
- corollary, A-1
- correspondence, 154, A-9
- coset, 186
- Cramer's rule, 325–327
- cross product, 294
- crystals, 136–139
  - diamond, 137
  - graphite, 137
  - salt, 136
  - unit cell, 137
  
- da Vinci, Leonardo, 331
- degree of polynomial, 344
- determinant, 290, 295–313
  - cofactor, 321
  - Cramer's rule, 326
  - definition, 295
  - exists, 304, 310
  - Laplace expansion, 321
  - minor, 321
  - permutation expansion, 303, 307, 328
- diagonal matrix, 202, 218
- diagonalizable, 351–354
- difference equation, 409
  - homogeneous, 409
- dilation, 157, 268
  - representing, 195
- dimension, 114
  - physical, 146
- dimensional constant, 146
- dimensional formula, 146
- direct map, 286
- direct sum, 125–133
  - definition, 129
  - external, 162
  - internal, 162
  - of two subspaces, 129
- direction vector, 34
- distance-preserving, 283
- division theorem, 344
- domain, A-8
- dot product, 39
- double precision, 65
- dual space, 186
  
- echelon form, 5
  - free variable, 12
  - leading variable, 5
  - reduced, 46
- eigenspace, 358
- eigenvalue, eigenvector
  - of a matrix, 355
  - of a transformation, 354
- element, A-6
- elementary
  - matrix, 219, 267
- elementary reduction operations, 4
  - rescaling, 4
  - row combination, 4
  - swapping, 4
- elementary row operations, 4
- elimination, 3
- empty set, A-7
- entry, 13
- equivalence
  - class, A-11
    - canonical representative, A-11
  - relation, A-10
  - representative, A-11
- equivalence relation, A-9
  - isomorphism, 163
  - matrix equivalence, 237
  - matrix similarity, 348
  - row equivalence, 48
- equivalent statements, A-3
- Erlanger Program, 283
- Euclid, 283
- even functions, 92, 131
- even polynomials, 397

- external direct sum, 162
- Fibonacci sequence, 408
- field, 134–135
  - definition, 134
- finite-dimensional vector space, 112
- flat, 35
- free variable, 12
- full column rank, 124
- full row rank, 124
- function, A-8
  - inverse image, 178
  - argument, A-8
  - codomain, A-8
  - composition, 209, A-8
  - correspondence, A-9
  - domain, A-8
  - even, 92
  - identity, A-8
  - inverse, 224, A-9
  - left inverse, 223
  - multilinear, 300
  - odd, 93
  - one-to-one, A-9
  - onto, A-9
  - range, A-8
  - restriction, A-9
  - right inverse, 223
  - structure preserving, 155, 159
    - see homomorphism 169
  - two-sided inverse, 224
  - value, A-8
  - well-defined, A-8
  - zero, 170
- Fundamental Theorem
  - of Linear Algebra, 260
- Gauss' method, 3
  - accuracy, 63–66
  - back-substitution, 5
  - elementary operations, 4
  - Gauss-Jordan, 46
- Gauss-Jordan, 46
- Gaussian elimination, 3
- generalized nullspace, 365
- generalized rangespace, 365
- Geometry of Linear Maps, 266–271
- Google matrix, 406
- Gram-Schmidt process, 247–252
- historyless, 278
- homogeneous coordinate vector, 334
- homogeneous coordinates, 288
- homogeneous equation, 21
- homomorphism, 169
  - composition, 209
  - matrix representing, 187–197
  - nonsingular, 200
  - nullity, 181
  - nullspace, 181
  - rangespace, 177
  - rank, 199
  - singular, 200
  - zero, 170
- hyperplane, 36
- ideal line, 337
- ideal point, 337
- identity
  - function, A-8
  - matrix, 217
- if-then statement, A-2
- ill-conditioned, 64
- image
  - under a function, A-8
- improper subspace, 86
- incidence matrix, 222
- index
  - of nilpotency, 368
- induction, 23, A-4
  - hypothesis, A-5
- inductive step
  - of induction, A-5
- inherited operations, 76
- inner product, 39
- Input-Output Analysis, 59–62
- internal direct sum, 129, 162
- intersection, A-7
- invariant
  - subspace, 376
- invariant subspace
  - definition, 388
- inverse, 224, A-9
  - additive, 74
  - exists, 224
  - left, 224, A-8
  - matrix, 323
  - right, 224, A-8
  - two-sided, A-9
- inverse function, 224
- inverse image, 178

- inversion, 308
- isometry, 283
- isomorphism, 153–168
  - characterized by dimension, 166
  - definition, 154
  - of a space with itself, 157
- Jordan block, 387
- Jordan form, 377–397
  - represents similarity classes, 391
- kernel, 181
- Kirchhoff's Laws, 68
- Klein, F., 283
- Laplace expansion, 320–324
  - computes determinant, 321
- leading variable, 5
- least squares, 261–265
- lemma, A-1
- length, 38
- Leontief, W., 59
- line
  - best fit, 262
  - in projective plane, 336
- line at infinity, 337
- line of best fit, 261–265
- linear
  - transpose operation, 124
- linear combination, 2
- Linear Combination Lemma, 50
- linear elimination, 3
- linear equation, 2
  - coefficients, 2
  - constant, 2
  - homogeneous, 21
  - inconsistent systems, 261
  - satisfied by a vector, 15
  - solution of, 2
    - Gauss' method, 3
    - Gauss-Jordan, 46
  - solutions of
    - Cramer's rule, 326
  - system of, 2
- linear map
  - dilation, 268
  - reflection, 268, 286
  - rotation, 267, 286
  - seehomomorphism, 169
  - skew, 269
  - trace, 396
- linear maps
  - space of, 173
- linear recurrence, 409
- linear recurrences, 408–415
- linear relationship, 96
- linear surface, 35
- linear transformation
  - seetransformation, 172
- linearly dependent, 96
- linearly independent, 96
- LINPACK, 57
- magic square, 272
  - normal, 273
- magic squares, 272–276
- map, A-8
  - distance-preserving, 283
  - extended linearly, 166
  - restriction, 367
  - self composition, 363
- Maple, 57
- Markov chain, 278
  - historyless, 278
- Markov chains, 277–282
- Mathematica, 57
- mathematical induction, 23, A-5
- MATLAB, 57
- matrix, 13
  - adjoint, 322
  - antisymmetric, 132
  - augmented, 14
  - block, 239, 306
  - change of basis, 231
  - characteristic polynomial, 358
  - cofactor, 321
  - column, 13
  - column space, 119
  - conditioning number, 65
  - determinant, 290, 295
  - diagonal, 202, 218
  - diagonalizable, 351
  - diagonalized, 237
  - elementary reduction, 219, 267
  - entry, 13
  - equivalent, 237
  - Google, 406
  - identity, 213, 217
  - incidence, 222
  - inverse, 223–230, 323

- inverse, definition, 224
- magic square, 272
- main diagonal, 217
- Markov, 222
- matrix-vector product, 190
- minimal polynomial, 214, 378
- minor, 321
- multiplication, 208
- nilpotent, 368
- nonsingular, 27, 200
- orthogonal, 285
- orthonormal, 283–288
- permutation, 218, 303
- rank, 199
- representation, 189
- row, 13
- row equivalence, 48
- row rank, 118
- row space, 118
- scalar multiple, 205
- scalar multiplication, 15
- similar, 319
- similarity, 348
- singular, 27
- skew-symmetric, 306
- sparse, 398
- stochastic, 278, 406
- submatrix, 298
- sum, 15, 205
- symmetric, 111, 132, 207, 213, 222, 260
- trace, 206, 222, 273, 396
- transition, 278
- transpose, 19, 120, 207
- triangular, 196, 222, 324
- tridiagonal, 399
- unit, 215
- Vandermonde, 306
- zero, 206
- matrix equivalence, 235–242
  - canonical form, 238
  - definition, 237
- mean
  - arithmetic, 43
  - geometric, 43
- member, A-6
- method of powers, 398–401
- minimal polynomial, 214, 378
- minor, 321
- morphism, 155
- multilinear, 300
- multiplication
  - matrix-matrix, 208
  - matrix-vector, 190
- mutual inclusion, A-6
- natural representative, A-11
- networks, 67–72
  - Kirchhoff's Laws, 68
- nilpotency
  - index, 368
- nilpotent, 367–376
  - canonical form for, 372
  - definition, 368
  - matrix, 368
  - transformation, 368
- nonsingular, 200, 224
  - homomorphism, 200
  - matrix, 27
- norm, 38
- normal, 256
- normalize, 38, 250
- nullity, 181
- nullspace, 181
  - closure of, 365
  - generalized, 365
- odd functions, 93, 131
- one-to-one function, A-9
- onto function, A-9
- opposite map, 286
- order
  - of a recurrence, 410
- ordered pair, A-8
- orientation, 315, 319
- orientation preserving map, 286
- orientation reversing map, 286
- orthogonal, 41
  - basis, 249
  - complement, 255
  - mutually, 248
  - projection, 255
- orthogonal matrix, 285
- orthogonalization, 249
- orthonormal basis, 250
- orthonormal matrix, 283–288
- page ranking, 404–407
- pair
  - ordered, A-8



- parallelepiped, 314
- parallelogram rule, 33
- parameter, 13
- parametrized, 13
- partial pivoting, 65
- partition, A-10–A-11
  - matrix equivalence classes, 237, 240
  - row equivalence classes, 48
- partitions
  - into isomorphism classes, 163
- permutation, 303
  - inversions, 308
  - matrix, 218
  - signum, 309
- permutation expansion, 303, 307, 328
- permutation matrix, 303
- perp, 255
- perpendicular, 41
- perspective
  - triangles, 338
- Physics problem, 1
- pivoting, 46
  - full, 65
  - partial
    - scaled, 65
- plane figure, 283
  - congruence, 283
- point
  - at infinity, 337
  - in projective plane, 334
- polynomial, 344
  - associated with recurrence, 411
  - constant, 344
  - degree, 344
  - division theorem, 344
  - even, 397
  - leading coefficient, 344
  - minimal, 378
  - of map, matrix, 377
- populations, stable, 402–403
- potential, 67
- powers, method of, 398–401
- preserves structure, 169
- probability vector, 278
- projection, 169, 178, 243, 260, 384
  - along a subspace, 253
  - central, 331
    - vanishing point, 331
  - into a line, 244
  - into a subspace, 253
    - orthogonal, 244, 255
- Projective Geometry, 331–342
- projective geometry
  - Duality Principle, 336
- projective plane
  - ideal line, 337
  - ideal point, 337
  - lines, 336
- proof techniques
  - induction, 23
- proper
  - subset, A-6
- proper subspace, 86
- proposition, A-1
- propositions
  - equivalent, A-3
- quantifier, A-3
  - existential, A-4
  - universal, A-3
- quantifiers, A-3
- range, A-8
- rangespace, 177
  - closure of, 365
  - generalized, 365
- rank, 122, 199
  - column, 119
  - of a homomorphism, 177, 182
- recurrence, 321, 408, 409
  - associated polynomial, 411
  - homogeneous, 409
  - initial conditions, 410
- reduced echelon form, 46
- reflection, 268, 286
  - glide, 286
- reflection (or flip) about a line, 157
- reflexivity, A-10
- relation, A-9
  - equivalence, A-9, A-10
  - reflexive, A-10
  - symmetric, A-10
  - transitive, A-10
- relationship
  - linear, 96
- representation
  - of a matrix, 189
  - of a vector, 109
- representative, A-11
  - canonical, A-11

- for row equivalence classes, 54
  - of matrix equivalence classes, 238
  - of similarity classes, 392
- rescaling rows, 4
- resistance, 67
- resistance:equivalent, 71
- resistor, 68
- restriction, 367, A-9
- rigid motion, 283
- root
  - characteristic, 362
- rotation, 267, 286
- rotation (or turning), 157
  - represented, 192
- row, 13
  - rank, 118
  - vector, 14
- row equivalence, 48
- row rank, 118
  - full, 124
- row space, 118
- Sage, 57
- scalar, 74
- scalar multiple
  - matrix, 205
  - vector, 15, 33, 74
- scalar multiplication
  - matrix, 15
- scalar product, 39
- scaled partial pivoting, 65
- Schwartz Inequality, 40
- self composition
  - of maps, 363
- sense, 316
- sensitivity analysis, 226
- sequence, A-8
  - concatenation, 127
- set, A-6
  - complement, A-7
  - element, A-6
  - empty, A-7
  - intersection, A-7
  - member, A-6
  - union, A-7
- sets, A-6
  - dependent, independent, 96
  - empty, 98
  - mutual inclusion, A-6
  - proper subset, A-6
  - span of, 89
  - subset, A-6
- sgn
  - seesignum, 309
- signum, 309
- similar, 294, 319
  - canonical form, 391
- similar matrices, 348
- similar triangles, 286
- similarity, 348–362
- similarity transformation, 362
- single precision, 63
- singular
  - homomorphism, 200
  - matrix, 27
- size, 314, 316
- skew, 269
- skew-symmetric, 306
- span, 89
  - of a singleton, 93
- sparse matrix, 398
- spin, 142
- square root, 397
- stable populations, 402–403
- standard basis, 107
- state, 277
- Statics problem, 5
- stochastic matrix, 278, 406
- string, 369
  - basis, 369
  - of basis vectors, 368
- structure
  - preservation, 169
- submatrix, 298
- subspace, 85–94
  - closed, 87
  - complementary, 129
  - definition, 85
  - direct sum, 129
  - improper, 86
  - independence, 129
  - invariant, 388
  - proper, 86
  - sum, 125
- sum
  - matrix, 15
  - of matrices, 205
  - of subspaces, 125
  - vector, 15, 33, 74
- summation notation

- for permutation expansion, 304
  - swapping rows, 4
  - symmetric matrix, 111, 132, 207, 213
  - symmetry, A-10
  - system of linear equations, 2
    - elimination, 3
    - Gauss' method, 3
    - Gaussian elimination, 3
    - linear elimination, 3
    - solving, 2
- theorem, A-1
- Tower of Hanoi, 412
- trace, 206, 222, 273, 396
- transformation
  - characteristic polynomial, 358
  - composed with itself, 363
  - diagonalizable, 351
  - eigenspace, 358
  - eigenvalue, eigenvector, 354
  - Jordan form for, 391
  - minimal polynomial, 378
  - nilpotent, 368
    - canonical representative, 372
  - projection, 384
  - size change, 316
- transition matrix, 278
- transitivity, A-10
- translation, 284
- transpose, 19, 120
  - determinant, 304, 312
  - interaction with sum and scalar multiplication, 207
- Triangle Inequality, 39
- triangles
  - similar, 286
- triangular matrix, 222
- Triangularization, 196
- tridiagonal form, 399
- trivial space, 78, 107
- turning map, 157
- union, A-7
- unit matrix, 215
- vacuously true, A-2
- value, A-8
- Vandermonde matrix, 306
- vanishing point, 331
- vector, 14, 32
  - angle, 41
  - canonical position, 32
  - column, 14
  - component, 14
  - cross product, 294
  - direction, 34
  - dot product, 39
  - free, 32
  - homogeneous coordinate, 334
  - length, 38
  - natural position, 32
  - norm, 38
  - normalize, 38
  - orthogonal, 41
  - probability, 278
  - representation of, 109, 231
  - row, 14
  - satisfies an equation, 15
  - scalar multiple, 15, 33, 74
  - standard position, 32
  - sum, 15, 33, 74
  - unit, 43
  - zero, 22, 74
- vector space, 74–94
  - basis, 106
  - closure, 74
  - complex scalars, 84
  - definition, 74
  - dimension, 114
  - dual, 186
  - finite dimensional, 112
  - homomorphism, 169
  - isomorphism, 154
  - map, 169
  - over complex numbers, 343
  - subspace, 85
  - trivial, 78, 107
- Venn diagram, A-1
- voltage drop, 68
- volume, 316
- voting paradox, 140
  - majority cycle, 140
  - rational preference order, 141
- voting paradoxes, 140–145
  - spin, 142
- well-defined, A-8
- Wheatstone bridge, 69
- zero

divisor, [213](#)  
zero division, [230](#)  
zero divisor, [213](#)  
zero homomorphism, [170](#)  
zero matrix, [206](#)  
zero vector, [22](#), [74](#)